

EQUIPMENT CROSS REFERENCE

FITS OEM# SSC# DESCRIPTION	FITS OEM# SSC# DESCRIPTION	FITS OEM# SSC# DESCRIPTION
ACURA SPA		
AQUAHEAT 1 1/2" & AQUAHEAT PLUS 2" PUMPS		
1059	O-2041	Large Pump O-ring
1081	O-2301	Diffuser O-ring
1090-A	MS-1000	Pump Seal
AMERICAN PRODUCTS		
AMERICANA PUMP		
393003	O-2054	Lid O-ring
395005	MS-201	Pump Seal
395012	G-4409	Pot to Volute Gasket
395012	G-5045	Seal Plate O-ring (After 7/75)
397018	O-2026	Volute O-ring
<i>Repair/Service Kit Available...See pg. 70.</i>		
AMERICANA II PUMP		
391015	O-2079	Volute O-ring
391016	O-2066	Body O-ring
391019	O-2218	Lid O-ring
397012	MS-1000	Pump Seal
<i>Repair/Service Kit Available...See pg. 70.</i>		
BRONZE/BRONZE PUMP		
393003	O-2054	Lid O-ring
395012	G-4409	Pot to Volute Gasket
397012	MS-1000	Pump Seal
397028	O-2026	Volute to Seal Plate O-ring
<i>Repair/Service Kit Available...See pg. 70.</i>		
BRONZE/NORYL PUMP		
393003	O-2054	Lid O-ring
395005	MS-201	Pump Seal
395012	G-4409	Pot to Volute Gasket
397028	O-2026	Volute to Seal Plate O-ring
<i>Repair/Service Kit Available...See pg. 70.</i>		
EAGLE PUMP		
392003	O-2095	Volute O-ring
392041	O-2060	Lid O-ring
392048	G-4284	Gasket
397012	MS-1000	Pump Seal
<i>Repair/Service Kit Available...See pg. 70.</i>		
MAXIM PUMP		
391015	O-2079	Body O-ring
391019	O-2218	Lid O-ring
391028	O-2165	Swivel Union O-ring
397012	MS-1000	Pump Seal
570065	O-2090	O-ring
<i>Repair/Service Kit Available...See pg. 70.</i>		
POWERGLAS PUMP		
391016	O-2066	Face Plate O-ring
391019	O-2218	Hair Lint Pot O-ring
397012	MS-1000	Pump Seal
421612	O-2262	Volute O-ring
422160	G-4221	Pump Gasket
468240	O-2195	Slip Body O-ring
<i>Repair/Service Kit Available...See pg. 70.</i>		
POWER PUMP		
390004	O-2080	Lid O-ring
390008	G-4120	Pump Gasket
390022	O-1060	Body O-ring
390040	O-2195	Diffuser O-ring
510034	O-2115	Adapter O-ring
ULTRA FLOW PUMP		
390066	O-2111	Diffuser Gasket
390060	O-1082	Volute O-ring
393003	O-2054	Lid O-ring
395012	G-4498	Pot to Volute Gasket
397018	O-2026	Volute O-ring
397020	MS-1000	Pump Seal
393006	O-2054	Locking Ring Lid O-rng
570065	O-2090	O-ring
<i>Repair/Service Kit Available...See pg. 70.</i>		
CARTRIDGE FILTER-CARIBE-133, 184, 368, 52, 104 FIBERGLASS		
510135	O-2106	O-ring-133, 184, 368
510136	G-4278	Bulkhead Gasket- 133,184,368
510137	G-4237	Bulkhead Gasket- 133, 184, 368
530028	O-1039	18" Tank O-ring- 133, 184, 368
570031	O-1060	Bottom Seal O-ring- 52, 104
570032	O-1014	12" Tank O-rng-52, 104
CARTRIDGE FILTER-COMMANDER-25, 35, 50, 75, 100, 150 SQ. FT.		
570065	O-2090	Gauge Plug O-ring
570067	O-2129	Knob Seal O-ring
570073	O-1059	Tank O-ring
570078	O-2223	Rod O-ring
<i>O-ring/Gasket Kit Available...See pg. 73.</i>		
CARTRIDGE FILTER-COMMANDER II-SPA, ABOVE GROUND-20, 25 SQ. FT.		
387028	O-2026	Filter Head O-ring
570065	O-2090	O-ring
CARTRIDGE FILTER-PREDATOR-50, 75, 100, 150, 200 SQ. FT.		
873004	O-2375	Body O-ring
863005	G-4458	Drain Cap Gasket
391028	O-2165	Union O-ring
CARTRIDGE FILTER-QUANTUM STAINLESS STEEL-175, 350 SQ. FT.		
510136	G-4278	Bulkhead Gask-Thick
510137	G-4237	Bulkhead Gasket
530088	O-1143	18" O-ring (Aft 11/94)
850057	O-2231	O-ring
<i>O-ring/Gasket Kit Available...See pg. 73.</i>		
CARTRIDGE FILTER-QUANTUM COMPOSITE-175, 350, 500 SQ. FT.		
590210	O-1142	O-ring
510137	G-4237	Bulkhead Gasket
510136	G-4278	Bulkhead Gasket
850057	O-2231	O-ring
CARTRIDGE FILTER-QUANTUM-RPM-350, 500 SQ. FT.		
390102	O-1141	Clamp O-ring
391029	O-2040	Bulkhead O-ring
850057	O-2231	Drain Plug O-ring
D.E. FILTER-SPIN		
510031	O-2024	Shaft O-ring
530004	G-4298	Flat Gasket
530018	O-2402	Quad Ring
530028	O-1039	18" Tank O-ring
D.E. FILTER-TITAN STAINLESS STEEL-24, 36, 48, 60, 72 SQ. FT.		
510135	O-2106	O-ring (Before 1990)
510136	G-4278	Bulkhead Gasket
510137	G-4237	Bulkhead Gasket
530028	O-1039	18" Tank O-ring (Before 11-94)
391029	O-2040	O-ring (After 1990)
850057	O-2231	O-ring
510133	G-4371	Bulkhead Gasket
530088	O-1143	18" Tank O-ring (After 11-94)
510035	O-2106	Outlet O-ring
<i>O-ring/Gasket Kit Available...See pg. 73.</i>		
D.E. FILTER-TITAN COMPOSITE MATERIAL-24, 36, 48, 60, 72 SQ. FT.		
590210	O-1142	O-ring
510137	G-4237	Bulkhead Gasket
470642	O-2082	Lid Fitting O-ring
510136	G-4278	Bulkhead Gasket
391029	O-2040	Bulkhead O-ring
D.E. FILTER-TITAN RPM-350, 500 SQ. FT.		
390102	O-1141	Tank Clean O-ring
391029	O-2040	Bulkhead O-ring
850057	O-2231	Drain Plug O-ring
D.E. FILTER-WARRIOR AUTOMATIC REGENERATION FILTER		
873004	O-2375	Body O-ring
863005	G-4458	Drain Cap Gasket
391028	O-2165	Union O-ring
SAND FILTER-ECLIPSE AND METEOR TM-18", 20", 22", 26", 30"		
510116	O-2054	Valve O-ring-Eclipse
510119	O-2224	Standpipe O-ring
863005	G-4458	Drain Cap Gasket
510050	O-2068	Drain O-ring
SAND FILTER-ECLIPSE SM-26", 30", 36"		
520005	O-2054	Top O-ring
570068	O-2239	O-ring
510050	O-2068	Drain O-ring
SAND FILTER-OLYMPIAN FIBERGLASS		
392003	O-2095	Lid O-ring
392041	O-2060	Lid O-ring-TM Series
510035	O-2106	Union O-ring
510136	G-4278	Bulkhead Gask-Thick
510137	G-4237	Bulkhead Gasket
<i>O-ring/Gasket Kit Available...See pg. 73.</i>		

Please Note: Parts listed by Manufacturer number start on page 13.

EQUIPMENT CROSS REFERENCE

FITS OEM#	SSC#	DESCRIPTION
SAND FILTER-OLYMPIAN SIDE MOUNT-FIBERGLASS		
392003	O-2095	Lid O-ring
510137	G-4237	Bulkhead Gasket
590006	O-2106	Bulkhead O-ring
391029	O-2040	Bulkhead O-ring
510136	G-4278	Thin Gasket
SAND FILTER-SANDPIPER S.S.-18", 24"		
510135	O-2106	O-ring-18", 24"
510136	G-4278	Bulkhd Gask-18",24"
510137	G-4237	Bulkhd Gask-18",24"
530028	O-1039	18" Tank O-ring
550009	G-4311	Hub Gask-18",24",30"
550017	O-1042	24" Tank O-ring
550067	O-2239	Drain O-ring-30"
391029	O-2040	O-ring-Current Version
530088	O-1143	18" Tank O-ring (After 11-94)
850057	O-2231	Drain Plug O-ring
1 1/2" MULTIPOINT VALVE-SIDE MOUNT-501501, 501601		
510010	O-2410	Lid Quad Ring
510012	O-2133	Shaft O-ring
510013	G-5146	Back Up Ring-Teflon
510018	G-4300	Sight Glass Gasket (For Kit Order 2)
510084	G-5104	Spider Gask (Bef. '76)
--	G-5105	Spider Gask (Aft. '76)
<i>Repair/Service Kit Available...See pg. 73.</i>		
2" MULTIPOINT VALVE-P SERIES, SIDE MOUNT		
982207	O-2256	Shaft O-ring (2)
982214	G-4625	Sight Glass Gasket
MULTIPOINT VALVE-5 & 8 POSITION TOP MOUNT CLAMP-ON		
501517	O-2211	Lid O-ring
501519	O-2256	Rotor O-ring (2)
501523	O-2378	Backwash Sight Glass O-ring
520005	O-2054	26, 30" Sand Filter O-r
MULTIPOINT VALVE-6 POSITION TOP MOUNT CLAMP-ON		
510022	O-2025	1 1/2" Valve Lid O-r
510023	O-2374	2" Valve Lid O-ring
510026	O-2256	Rotor O-ring
510054	G-4319	Sight Glass Gasket
510058	O-2189	1 1/2" Valve Standpipe O-ring
510119	O-2224	22" Filter O-ring
520005	O-2054	26 & 30" Filter O-ring
1 1/2" & 2" SLIDE VALVE-PUSH PULL-ABS 2"		
510049	G-3148	Valve Cap Gasket
510135	O-2106	Valve Cap Body O-r
510031	O-2024	Stem & Shaft Cap O-r
510034	O-2115	Valve Cap O-ring
510050	O-2068	Valve Piston O-ring
467150	O-2126	Valve Stem O-ring
510104	O-2142	Old Style Valve Piston O-ring
<i>Repair/Service Kit Available...See pg. 73.</i>		

FITS OEM#	SSC#	DESCRIPTION
2" SIDE MOUNT VALVE-M SERIES		
510167	O-2297	Lid O-ring
510177	O-2256	O-ring (2)
510173	G-4394	Gasket
5 & 8 POSITION TOP MOUNT VALVE-1 1/2"-501151, 501181, 501182, 501183		
501517	O-2211	Lid O-ring
501519	O-2256	Rotor O-ring
6 POSITION TOP MOUNT VALVE-1 1/2" & 2"-501131, 501130, 501231		
510022	O-2025	1 1/2" O-ring
510023	O-2374	2" O-ring
510026	O-2256	O-ring
SKIMMERS		
451170	G-4002	Sealing Gasket-Twin Port Spa
570082	O-2226	Equalizer O-ring-S20 Admiral
850016	G-4008	Sealing Liner Rubber Gasket-Admiral
850016	G-3034	Sealing Liner Fiber Gasket-Admiral
850033	G-3011	Rear Sealing Gasket-FAS 100
850034	G-3009	Front Sealing Gasket-FAS 100
850077	G-3008	Wide Throat Sealing Gasket-Admiral
850151	O-2224	Bottom O-ring-S20 Admiral

ANTHONY		
AJ-104-1, AJ-105-1 & AJ-106-1 SERIES PUMPS		
4547	MS-100	Pump Seal
4465	G-3226	A.J. Gasket
AS-1, AS-2, AC-1, AC-2 PUMPS		
4380	MS-1000	Pump Seal
4382	G-3253	Volute Gasket
1 1/2" SELECTOR VALVE		
17437	O-2024	Small O-ring
17606	O-2142	Cap O-ring
17791	O-2004	Plastic Saddle O-r (2)
17606	O-2142	Brass Saddle O-r (2)
2" SELECTOR VALVE		
17437	O-2024	Small O-ring
17681	O-2231	Cap O-ring
17792	O-2188	Plastic Saddle O-r (2)
17681	O-2231	Brass Saddle O-r (2)

AQUA FLO		
A SERIES PUMP		
91500050	G-3256	Volute Gask-.33-2HP
91500100	G-3220	Volute Gasket-3 HP
91500250	G-4407	100% Drain Gasket
92200000	O-2228	5" Trap Cover O-ring
92200010	O-2247	6" Trap Cover O-ring
92500050	MS-1000	Pump Seal
AF12	G-3275	Trap Gasket
<i>Repair/Service Kit Available...See pg. 70.</i>		

FITS OEM#	SSC#	DESCRIPTION
AC SERIES PUMP		
91500000	G-3151	Volute Gasket
91500200	G-3240	6" and 8" Trap Gask.
92200010	O-2247	6" Trap Cover O-ring
B SERIES PUMP		
91500050	G-3256	Volute Gask-.33-2 HP
91500250	G-4407	100% Drain Trap Gsk
92200100	O-2226	O-ring
92500050	MS-1000	Pump Seal
C SERIES PUMP		
92200100	O-2226	O-ring
92200060	O-2141	O-ring
92200140	O-2195	O-ring
92200050	O-2067	Volute O-ring
92500050	MS-1000	Pump Seal
DOMINATOR PUMP		
92200140	O-2195	O-ring
92200180	O-1082	Seal Plate O-ring
92200100	O-2226	Suction O-ring
92200060	O-2141	O-ring
92200190	O-2128	Cover O-ring
92200210	O-2270	Bulkhead O-ring
92500050	MS-1000	Pump Seal (Pre-'95)
--	MS-200	Pump Seal (Since '95)
<i>Repair/Service Kit Available...See pg. 70.</i>		

FLO MASTER PUMP-FMCP & FMHP		
91049000	MS-2131	Pump Seal
92200000	O-2228	Trap Cover O-ring
92200090	O-2262	Volute O-ring
92200100	O-2226	Suction Flange O-ring
92200120	O-2253	Pipe Plug O-ring
92200140	O-2195	Fitting O-ring
92200200	O-2025	Volute O-ring
92200060	O-2141	Plug O-ring
<i>Repair/Service Kit Available...See pg. 70.</i>		

FLO MASTER PUMP-XP		
92200290	O-2214	Volute O-ring
92200060	O-2141	Drain Plug O-ring
92200210	O-2270	O-ring

FLO MASTER-FMVP		
91049000	MS-2131	Pump Seal
92200090	O-2262	Volute O-ring
92200120	O-2253	Drain Plug O-ring
92200100	O-2226	O-ring
92200140	O-2195	O-ring
92200200	O-2025	Volute O-ring

TUB MASTER PUMP		
91049000	MS-2131	Pump Seal
92200090	O-2262	Volute O-ring
92200140	O-2195	Fitting O-ring
92200200	O-2025	Volute O-ring

ARNESON		
POOLSWEEP		
F-7	O-2082	O-ring
G-29B	G-3237	Gear Housing Gasket
F-24	O-2135	O-ring
G-12	O-2208	O-ring
G-32	O-2263	O-ring
A-08A	MS-200	Pump Seal

EQUIPMENT CROSS REFERENCE

FITS

OEM# SSC# DESCRIPTION

CARTRIDGE FILTER-MICRO STAR CLEAR

CX0120-D O-2095 Lid O-ring
 SPX1485-C G-5033 Gasket/O-ring
O-ring/Gasket Kit Available...See pg. 73.

CARTRIDGE FILTER-SKIM FILTER-SF-400, SF-400-90

SPX1500-M O-2104 Small Drain Valve
 O-ring (Lower)
 SX0200-Z-9 G-4325 Drain Cap Gasket
 SPX1084-B G-3020 12-Hole Skimmr Gask
 SPX1090-E G-3006 10 Hole Skimmr Gask
 SPX1084Z4A SCR-410 Skimmer Screw

CARTRIDGE FILTER-STAR CLEAR-C-250, 500, 750

CX0250-F O-1215 Tank O-ring
 CX0250-Z-7 O-2116 Locking O-ring
 SPX0605-Z-2 O-2261 Drain Plug O-ring
 (1980-Present)
 SP1082Z410 O-2090 O-ring
O-ring/Gasket Kit Available...See pg. 73.

CARTRIDGE FILTER-STAR CLEAR II-C-800, 1100, 1500

CX0250-Z-7 O-2116 Locking O-ring
 CX0800-F O-1054 Lid O-ring
 SPX0605Z2 O-2261 Drain Plug O-ring
O-ring/Gasket Kit Available...See pg. 73.

CARTRIDGE FILTER-STAR CLEAR PLUS-C-751, 900, 1200, 1750Z

CX0900-H O-2239 O-ring
 CX0900-F O-2306 Filter Head O-ring
 SPX0605-Z2 O-2261 O-ring

CARTRIDGE FILTER-SUPER STAR CLEAR-MOLDED-C-2000, C-3000, C-4000

SX0200-Z-5 O-2133 Filter O-ring
 SX0200-Z-3 O-2270 Filter O-ring (Pre '95)
 SX0200-Z-4 O-2165 Filter O-ring
 DEX2400K O-1001 Tank O-ring
 DEX2400Z3A O-2253 Relief Valve Stem O-r
 DEX0360-M O-2199 O-ring
O-ring/Gasket Kit Available...See pg. 73.

CARTRIDGE FILTER-SUPER STAR CLEAR-STAINLESS STEEL-C-3000S, C-4000S

SPX1495Z1 O-2040 Base O-ring
 SPX0722-G O-2155 Inlet Elbow O-ring
 SPX0072-Z4 O-2208 Air Relief Valve Stem
 O-ring
 DEX0360-K O-1099 Tank O-ring
 DEX2400Z3A O-2253 Air Relief Valve Stem
 O-ring
 DEX2400-S5 G-4212 Gasket
 DEX0360-E O-2186 O-ring
 DEX0360-M O-2199 Bulkhead O-ring
 SX0200-Z-3 O-2270 Bulkhd O-rng (Pre '92)
 SX0200-Z-4 O-2165 O-ring
O-ring/Gasket Kit Available...See pg. 73.

FITS

OEM# SSC# DESCRIPTION

D.E. FILTER-MICRO CLEAR VERTICAL

GRID DE-2400-6000
 DEX2400-K O-1001 Tank O-ring
 DEX2400Z5 O-2106 Outlet Elbow O-ring
 DEX2400Z3A O-2253 Relief Valve Stem O-r
 ECX1287 O-2105 Outlet Elbow O-ring
 SX0200-Z-3 O-2270 O-ring
 SX0200-Z-4 O-2165 O-ring
 SX0200-Z-5 O-2133 Relief Valve O-ring
 SPX1485-C G-5033 Gasket (Prior 1986)
 SX0360-Z-1 O-2355 Permaglas Body O-rng

D.E. FILTER-MICRO CLEAR VERTICAL GRID DE-7200

DEX0360-E O-2186 O-ring
 DEX0360-K O-1099 Tank O-ring
 DEX0360-M O-2199 Small O-ring
 DEX2400-S5 G-4212 Relief Valve-Tank O-rng
 DEX2400-Z5 O-2106 Outlet Elbow O-ring
 ECX1287 O-2105 Gauge Adapter O-ring
 SX0200-Z-3 O-2270 Large O-ring
 SX0200-Z-4 O-2165 O-ring
 DEX2400Z3A O-2253 Relief Valve Stem O-r
 SPX1495-Z-1 O-2040 O-ring

D.E. FILTER-PERFLEX EC-30, 40, 50

ECX1287 O-2105 Gauge Adapter O-ring
 ECX9611246 O-2135 Shaft O-ring
 ECX1003 G-5153 Diaphragm Gasket
O-ring/Gasket Kit Available... See pg. 73.

D.E. FILTER-PERFLEX EC-60 SERIES II

ECX9611246 O-2135 Shaft O-ring
 SPX1425-Z6 O-2195 Inlet Fitting O-ring

D.E. FILTER-PERFLEX EC-65, EC-75

ECX1287 O-2105 Adapter O-ring
 ECX9611246 O-2135 Shaft O-ring
 SPX1425Z6 O-2195 Inlet Fitting O-ring
 (Prior to 1989)
 SPX1500-W O-2152 O-ring (1990 on)
 ECX1105 G-5152 Diaphragm Gasket
O-ring/Gasket Kit Available...See pg. 73.

D.E. FILTER-REGEN-X RG-450, 700

RGX0045-G O-1144 Filter Head O-ring
 SP1082Z410 O-2090 Piston O-ring

SAND FILTER-E-100, E-200, E-250 & SAND MASTER-SM1700T, SM1900T, SM2300T

GMX600-F O-2058 Valve/Tank O-ring
 SX0180-G G-4443 Gasket

SAND FILTER-S-140T, 144T, 164T, 166T

GMX0400-F O-2164 Valve/Tank O-ring-
 S-140T
 GMX0600-F O-2058 Valve/Tank O-ring-
 144, 164, 166
 SX0180-G G-4443 Gasket
 SX0200-Z-5 O-2133 Air Valve O-ring
O-ring/Gasket Kit Available...See pg. 73.

FITS

OEM# SSC# DESCRIPTION

SAND FILTER-S-200, S-240

SX0240-Z-1 O-1044 Tank O-ring
 SX0200-Z-3 O-2270 O-ring
 SX0200-Z-4 O-2165 O-ring
 SX0200-Z-5 O-2133 Drain Pipe O-ring
 (Prior 1980)
 SX0200-Z-6 O-2091 Lid O-ring
 SX0200-Z-7 O-1106 Tank O-ring
 SX0200-Z-9 G-4325 Drain Gasket
 SX0200-Z-14 O-2261 Drain Pipe O-ring
 (After 1980)
 SPX1425-Z-6 O-2195 Inlet Fitting O-ring
 SPX1485-C G-5033 Elbow Gasket
O-ring/Gasket Kit Available...See pg. 73.

SAND FILTER-S-160T

SX0160-Z-1 O-1049 Tank O-ring
 SX0200-Z-5 O-2133 O-ring
 SX0200-Z-6 O-2091 Lid O-ring
 SX0200-Z-9 G-4325 Drain Gasket
 SX0200-Z-14 O-2261 O-ring
O-ring/Gasket Kit Available...See pg. 73.

SAND FILTER-S-210T, S-180T, S-244T, S-220T

GMX0600-F O-2058 Tank O-ring
 SX-180-G G-4443 Gasket

SAND FILTER-S-190T, S-245T

GMX0600-F O-2058 Tank O-ring
 SX0200-Z-9 G-4325 Drain Gasket
 SX0200-Z-14 O-2261 O-ring
O-ring/Gasket Kit Available...See pg. 73.

SAND FILTER-S-300T, S-310T

GMX0600-F O-2058 Tank O-ring
 SX0180-G G-4443 Gasket

SAND FILTER-S-210S, S-244S, S-220S, S-310S

DEX0360-M O-2199 O-ring
 GMX0600-F O-2058 Tank O-ring
 SX0180-G G-4443 Gasket
 SX0200-Z-5 O-2133 O-ring
 SX0200-Z-4 O-2165 O-ring
 SPX1425Z6 O-2195 O-ring
 SX220-Z-3 O-2282 O-ring

SAND FILTER-GM-140, 142, 142-G, 142HV

GMX0400-F O-2164 O-ring-140, 142
 GMX0600-F O-2058 O-ring-142-G, 142HV
 GMX0152Z5 O-2116 O-ring
 GMX142DA2 G-4462 Gasket
O-ring/Gasket Kit Available...See pg. 73.

SAND FILTER-GM-152, 152HV

GMX0152Z5 O-2116 Drain Plug O-ring
 GMX0600-F O-2058 Tank O-ring
 GMX600FST O-1095 Valve O-ring

SAND FILTER-S-311SX, 311SXV, 360SX

SX0200-Z-5 O-2133 O-ring
 SX0180-G G-4443 Drain Cap Gasket
 SX0200-Z-4 O-2165 Valve O-ring
 DEX2400Z3A O-2253 Relief Valve Stem O-r
 SX0220-Z-3 O-2282 O-ring (S-311 '95
 & Prior)
 SX0360-Z-1 O-2355 O-ring S-311, S-360
 (After '95)

EQUIPMENT CROSS REFERENCE

FITS	FITS	FITS
OEM# SSC# DESCRIPTION	OEM# SSC# DESCRIPTION	OEM# SSC# DESCRIPTION
MULTIPORT VALVE-1 1/2" VARI-FLO-4 POSITION-SP-704 SPX710-Z-16 G-3277 Non Metallic Bearing SPX704-F O-2128 Cover O-ring	BALL VALVE-SP-722, 723 AND UN 1 1/2" TRIMLINE SPX722-H O-2124 Stem O-ring SPX722-G O-2155 End Connector O-ring SPX1495-Z-1 O-2040 Flush Union End O-rg	LVL-VECTOR SERIES 47-0352-41 O-2059 Strainer Cover O-ring 47-0258-53 G-5060 Square Ring 10-0002-06 MS-200 Pump Seal
MULTIPORT VALVE-1 1/2"-SP-710, 711, 712-1976 AND ON SPX710-R G-4280 Sight Glass Gasket SPX710-XD G-5106 Spider Gasket SPX710-Z3 O-2025 Cover O-ring SPX170-GA K-6001 Valve Stem O-ring Kit SPX710X-Z3 O-2128 Cover O-ring SPX735-G O-2256 Valve Stem O-ring SPX1022CZ2 O-2115 O-ring	BALL VALVE-SP-729-1 1/2" 2 WAY SPX728-H O-2243 End Connector O-ring SPX1441-Z-1 O-2141 Stem O-ring	LR, SLR SERIES PUMPS 10-1436-00 MS-200 Pump Seal 47-0352-41 O-2059 Lid O-ring 47-0112-00 O-2024 Plug O-ring 47-0258-53 G-5060 Bracket to Case O-ring <i>Repair/Service Kit Available...See pg. 71.</i>
MULTIPORT VALVE-1 1/2"-SP-710, 1969-75 SPX0603-Z2 O-2133 Stem O-ring w/Teflon Seal SPX0710-D G-5108 Spider Gasket SPX0710-Z3 O-2025 Cover O-ring SPX0710-R G-4280 Sight Glass Gasket	BALL VALVE-SP-724, 725, 726, 2" TRIMLINE SPX735-G O-2256 Stem O-ring SPX724-G O-2117 End Connector O-ring	MAGNUM PUMP 10-1390-04 MS-201 Pump Seal 47-0112-00 O-2024 Plug O-ring 47-0232-54 G-5031 Differential Square Rg 47-0358-03 O-2224 Lid O-ring-After 7/89 47-0364-47 O-2058 Housing O-ring 47-0434-01 O-2080 Lid O-ring-Prior 7/89 47-0442-01 O-2094 Case O-ring <i>Repair/Service Kit Available...See pg. 71.</i>
MULTIPORT VALVE-2"-SP-715, 716, 1976 AND ON SPX0710-R G-4280 Sight Glass Gasket SPX0175-Z1 O-2067 Cover O-ring SPX0735-GA K-6001 Valve Stem O-ring Kit SPX0735-G O-2256 Valve Stem O-ring	SKIMMERS SPX1097-E G-3003 Gasket-SP-1096, 1097, 1098 SPX1070-Z-1 O-2122 Float Valve Ass'y O-ring-SP-1070 SPX1084-B G-3020 Gasket-SP-1089, 1084, 1076 SPX1084-B3 G-3014 Gasket-SP-1084-OM SPX1085-D G-3001 Gasket-SP-1085, 1077 SPX1090-E G-3006 Gask-1090,1092-Fiber SPX1090-E G-4001 Gasket-SP-1090, 1092-Rubber SPX1094-G G-3002 Gasket-SP-1094, 1094H, SPA	P, PC, EP, UP, PH, UPH PUMPS 10-1203-01 MS-877 Pump Seal 47-0355-48 O-2236 Sandtrap Filter Lid O-r 47-0358-03 O-2041 Lid Gasket 47-0462-06 G-5046 Differential Square Rg 47-0466-02 G-5016 Square Ring 47-0463-05 G-5035 Strainer Cover Gasket 47-0353-40 O-2139 Cover O-ring 47-0112-00 O-2024 O-ring <i>Repair/Service Kit Available...See pg. 71.</i>
MULTIPORT VALVE-2"-SP-740DE SPX0715-Z1 O-2067 Cover O-ring SX0200-Z-4 O-2165 O-ring	FEEDER-200 SERIES-CL200, CL220, CL220BR CLX200-K O-2511 Cover O-ring-Viton CLX200-LA K-6003 O-ring Set	PJM PUMP 47-0348-06 O-2272 Cap O-ring-1 1/2" & 2" 47-0438-07 O-2247 Cap O-ring-2" & 2 1/2" 10-1203-01 MS-877 Pump Seal 13-0191-04 G-3176 Bracket Gasket-5, 7 1/2 HP 13-0314-06 G-3202 Bracket Gasket-3 HP 13-0379-08 G-4450 Flange Gasket-5, 7 1/2 HP <i>Repair/Service Kit Available...See pg. 71.</i>
MULTIPORT VALVE-VARIFLO XL 1.5" SPX0735-GA K-6001 Shaft Seal O-ring Kit	FEEDER-BROMINE-C250CF, C500CF SPX3000-SV O-2518 Cover O-ring-Viton SPX605-Z2V O-2515 Drain Plug O-rg-Viton	R & RC PUMP 10-1390-04 MS-201 Pump Seal 47-0112-00 O-2024 Plug O-ring 47-0358-03 O-2041 Lid O-ring (Prior 7/89) 47-0358-03 O-2224 Lid O-ring (After 7/89) 47-0462-06 G-5046 Square Ring 47-0466-02 G-5016 Square Ring <i>Repair/Service Kit Available...See pg. 71.</i>
MULTIPORT VALVE-FLANGE-1 1/2" SP-704 SPX0704-F O-2128 Cover O-ring	HERCULES SKIMMER-162010, 162025, 162050 1370097 G-4055 Skimmer Gasket	ULS PUMP 10-1203-01 MS-877 Pump Seal 13-0314-06 G-3202 Gasket 47-0357-04 O-2266 Lid O-ring-Bronze & C.I. Cover 47-0433-51 O-2266 Lid O-ring-New Lexan Cover
MULTIPORT VALVE-FLANGE-GM-400, 4 WAY SPX0072-Z4 O-2208 Stem O-ring GMX0400-D G-3185 Fiber Bearing Washer	JACUZZI CYGNET PUMP-7CYG (3/4HP), ICYG (1HP), 15 CYG (1 1/2HP)M 2CYG (2HP) 47-0352-41 O-2059 Strainer Cover O-ring 47-0112-99 O-2024 Plug O-ring 10-0002-06 MS-200 Pump Seal 47-0361-48 O-2300 O-ring <i>Repair/Service Kit Available...See pg. 71.</i>	CARTRIDGE FILTER-CF 13-0417-02 O-1116 Cover O-ring 47-0223-06 O-2231 Drain Plug O-ring
MULTIPORT VALVE-1 1/2" FLANGED-GM-600, 6 WAY GMX0600-P O-2248 Stem O-ring GMX0600-D O-2144 Teflon Bearing Washer	DB3 COMMERCIAL PUMPS 47-0022-09 O-2205 Sleeve O-ring 47-0165-06 O-2295 Case O-ring	
SLIDE VALVE-2"-SP-410X ECX9611246 O-2135 O-ring SPX0722-G O-2155 O-ring SPX0410-Z2 O-2150 Large Piston O-ring SPX0410-Z1 O-2008 Small Piston O-ring SX0200-Z-4 O-2165 O-ring	J, JCM, K, KM PUMPS 47-0357-46 O-2266 O-ring 10-0002-06 MS-200 Pump Seal <i>Repair/Service Kit Available...See pg. 71.</i>	
DIVERTER VALVE-PERFLEX-SP-727 SPX727-K O-2243 Cover O-ring SPX733-Z-1 O-2242 Key O-ring SPX1483-C O-2231 Union O-ring	L, LC, LCUN2, LT, LX, LTC, LCU, LTCU, ULCU, ULTCU, LCM PUMPS 47-0353-40 O-2139 O-ring 47-0258-53 G-5060 Square Ring	
DIAL-A FLO VALVE-SP-732, 733 SPX733Z1A O-2242 Key O-ring		
BALL VALVE-SP-720, 730, 735 SPX735-G O-2256 Stem O-ring SPX735-H O-2280 End Connector O-ring		

EQUIPMENT CROSS REFERENCE

FITS

OEM# SSC# DESCRIPTION

CARTRIDGE FILTER-CFR 50, 75, 100, 150

47-0106-08 O-2153 O-ring
 47-0380-47 O-2181 O-ring
 47-0112-00 O-2024 O-ring (Prior 1993)
 13-1023-06 G-4459 Gasket

Repair/Service Kit Available...See pg. 73.

CARTRIDGE FILTER-CFR25 & CFT25-SPA

47-0112-00 O-2024 Vent O-ring
 47-0360-09 O-2095 Cover O-ring
 47-0380-47 O-2181 Cover O-ring
 (75-200 Sq. Ft.)

O-ring/Gasket Kit Available...See pg. 73.

CARTRIDGE FILTER-SHERLOCK-SHER80, 120

47-0380-47 O-2181 O-ring
 13-0011-02 G-3406 Plug Gasket

CARTRIDGE FILTER-TRI-CLOPS & EARTHWORKS

47-0112-00 O-2024 Vent O-ring
 47-0228-35 O-2165 Bottom O-ring
 47-0212-66 O-2264 Manifold Knob O-ring
 47-0569-99 O-1015 Tank O-ring

O-ring/Gasket Kit Available...See pg. 74.

D.E. FILTER-AVALANCHE-AV40, 60, 80, 100

47-0380-47 O-2181 O-ring
 13-013-00 G-3407 1 1/2" Plug Gasket

D.E. FILTER-LANDSLIDE, D.E. SEPARATION TANK

47-0448-05 O-2024 Drain Plug O-ring
 47-0257-05 O-2143 Support O-ring
 47-0380-47 O-2181 Tank & Cover O-ring

O-ring/Gasket Kit Available...See pg. 74.

SAND FILTER-LASER-160L, 190L, 225L, 250L

13-0378-09 G-5023 Gasket
 47-0359-02 O-2224 Valve O-ring
 47-0434-01 O-2080 O-ring
 13-1022-07 G-4447 Drain Nozzle gasket

O-ring/Gasket Kit Available...See pg. 74.

SAND FILTER-SAND TRAP-RMST-24, ST-24

47-0355-06 O-2236 O-ring
 47-0326-02 O-2134 Valve Adapter O-ring

SAND FILTER-SAND TRAP-ST-27, ST-33

47-0355-06 O-2236 O-ring
 47-0443-00 O-2293 O-ring
 42-2927-06 O-1101 O-ring
 47-0326-02 O-2134 Inspection & Drain O-ring
 47-0213-08 O-2221 Plug O-ring

SAND FILTER-SANDSTORM 31

47-6172-04 O-2374 O-ring

SAND FILTER-MFM15

13-0378-09 G-5023 Gasket
 47-0112-00 O-2024 O-ring

SAND FILTER-MFM17, 20, 24

13-0378-09 G-5023 Valve Gasket
 47-0013-00 O-2248 Bottom Drain Plug O-ring

O-ring/Gasket Kit Available...See pg. 74.

FITS

OEM# SSC# DESCRIPTION

1 1/2" DV-5 DIAL VALVE-PLASTIC & BRONZE MODELS FOR PM FILTERS

47-0110-02 O-2090 O-ring
 47-0117-05 O-2220 Shaft O-ring
 13-0113-64 G-5023 Flange Square Ring

2" DIAL VALVE-39-2586-03

47-0364-47 O-2058 Cover O-ring
 47-0212-09 O-2256 O-ring
 13-1075-03 G-4618 Gasket
 47-0229-00 O-2226 O-ring

2" DV-5 DIAL VALVE-CAST IRON

47-0110-02 O-2090 O-ring
 47-0364-05 O-2058 O-ring
 47-0370-07 O-2278 O-ring
 47-0143-03 O-2049 O-ring

6-7 WAY DIAL VALVES-DVK-6, DVK-7, 15VK-24 & 15VK-27/33 PLASTIC VALVES

47-0214-07 O-2264 Key Assembly O-ring
 47-0258-53 G-5060 Square Ring (DVK-6)

DV-4 DIAL VALVE-FOR 15MFM FILTER

47-0214-07 O-2064 Key Assembly O-ring
 47-0248-56 G-5026 Square Ring

SKIMMERS

13-0411-08 G-3012 Face Gasket-WL, WC, WB Widemouth
 47-0248-56 G-5026 Square Ring

JANDY

MEDIUM HEAD PUMPS-MHP & MHPU UP RATED SERIES

R0338200 MS-601 Pump Seal
 R0340400 O-2214 Body O-ring
 R0338801 O-2100 Diffuser O-ring
 R0338900 O-2224 Pot Lid O-ring
 R0339600 O-2002 Coupling Set O-ring

HIGH HEAD PUMPS-HHP FULL RATED & HHPU UP RATED SERIES

R0338200 MS-601 Shaft Seal
 R0338700 O-2146 Body O-ring
 R0338801 O-2100 Diffuser O-ring
 R0338900 O-2224 Pot Lid O-ring
 R0339600 O-2002 Coupling Set O-ring

CARTRIDGE FILTERS-C200, C300, C400, CT50, CT75, CT100, CL580

R0350600 O-1160 Tank O-ring(C200-400)
 R0353400 O-2390 Lid O-ring (CT50-100)
 R0357800 O-1161 Tank O-ring (CL580)

CARTRIDGE FILTER-SHEER DESCENT-3456

3293 O-2125 Filter O-ring

D.E. FILTER-DEL60

R0357800 O-1161 Tank O-ring

2 & 3 PORT VALVES-NEVERLUBE & REGULAR

1132 O-2175 Valve Cover O-ring
 1307 O-2220 Valve Shaft O-ring (2)

FITS

OEM# SSC# DESCRIPTION

2 & 3 PORT SPACE SAVER VALVE

6749 O-2049 O-ring
 1307 O-2220 Valve Shaft O-ring (2)

90 DEGREE VALVE

1132 O-2175 Valve Cover O-ring
 1307 O-2220 Valve Shaft O-ring (2)

90 DEGREE SPACE SAVER VALVE

6749 O-2049 O-ring
 1307 O-2220 Valve Shaft O-ring (2)

LESLIE'S

HYDRAMAX II-SP-LE-40010 TP SP-LE-40019

5066-C1 O-2247 Strainer Cover O-ring
 SPX1600-R O-2618 Diffuser Gasket
 SPX1600-Z2 MS-201 Pump Seal
 SPX3000-T O-1217 Housing Gasket

HYDRAMAX A/G-ABOVE GROUND POOLS-SP-LE-40022 TO SP-LE-40026

SPX1500-KA MS-2131 Pump Seal
 SPX1705-Z1 O-2143 Housing O-ring
 SPX710-Z-3 O-2025 O-ring
 SPX1500-W O-2152 Strainer O-ring

LETRO

LA01N PUMP

LA1000 MS-1000 Pump Seal
 LA375 O-2253 Drain Plug O-ring
 LA415 O-2089 O-ring

MARLOW

AF SERIES PUMP

32540 G-5078 Strainer Cover Gasket
 15621 G-5073 Diffuser Gask-1-2 HP
 21035 O-2100 Diffuser Gasket-3 HP
 253532 MS-411 Pump Seal
 21034 G-3103 Housing Gasket

ARGONAUT PUMP

44308 O-2167 Cover O-ring
 38592 MS-201 Pump Seal
 44802 O-2094 Seal Plate Gasket

GEMINI WHIRLPOOL PUMP

40478 O-2189 O-ring
 42925 O-2118 O-ring

H SERIES PUMP

26144 G-5069 Diffuser Gasket-3/4 to 1 1/2 HP
 25475 O-2100 Diffuser Gasket-2 HP
 253532 MS-411 Pump Seal
 23112 G-3166 Housing Gasket

L SERIES STOCKLINE PUMPS

P48690 G-3404 Volute Gasket
 186862 BP-386 Pump Seal

EQUIPMENT CROSS REFERENCE

FITS	FITS	FITS
OEM# SSC# DESCRIPTION	OEM# SSC# DESCRIPTION	OEM# SSC# DESCRIPTION
MARDUR PUMP	SAND FILTER-FS592, FS792, FTA13, 72913 (15") & FS571, FS572, FS771, FS772, FTA15, 72910 (18")	DYNAMO & DYNAMO II PUMPS
25476 G-5017 Diffuser O-ring-1 1/2 & 2 HP	54020 G-3191 Gasket	27-3062 O-2040 Cap O-ring
30156 O-2140 Diffuser O-rng-1/3-1 HP	54055 G-3403 Gasket	35-4533 O-2139 Tank Lid O-ring (For Dynamo II)
37478 G-5014 Small Str. Cover Gask	54027 G-4218 Gasket	35-4535 O-2214 Bracket Diffuser O-rng
37479 G-5010 Strainer to Tank Gask		35-4545 MS-200 Pump Seal
37482 G-5052 Tank to Seal Plate Gasket	SAND FILTER-FS583-8, FS584-8, FS585-8, FS683-8, FS684-8, FS685-8, FS783-8, FS784-8, FS785-8	35-4571 O-2195 Connection O-ring (2) <i>Repair/Service Kit Available...See pg. 71.</i>
39404 G-5016 Strainer Cover Gasket- 1 1/2-2 HP	54072 O-2020 Gasket	HYDRO PUMP
38592 MS-201 Pump Seal	54055 G-3403 Gasket	19-2323 O-2106 Connector & Bulkhead O-ring
4SPC SERIES PUMPS	54027 G-4218 Tank Gasket	35-2602 O-2028 Lid O-ring
37478 G-5014 Gasket	54067 O-2256 Small O-ring	35-2626 O-2262 Volute O-ring
47040 G-3415 Gasket	54079 O-2128 Large O-ring	35-3525 O-2080 Lid O-ring (New Style)
47121 G-3414 Gasket		35-4001 MS-201 Pump Seal
MUSKIN	SAND FILTER-12" TANK ASSEMBLY-FS609, FTA10, 72901	35-5332 O-2172 Lid O-ring (Old Style)
CARTRIDGE FILTER-POLY ELEMENT-FE002-FE097	54007 G-3235 Gasket	35-2627 G-4104 Seal Plate Gasket <i>Repair/Service Kit Available...See pg. 71.</i>
54006 G-3194 Closure Nut Gasket	54027 G-4218 Tank Gasket	PINNACLE PUMP
54067 O-2256 Pump O-ring	54021 G-3195 Gasket	35-5619 O-2294 Seal Bracket O-ring
54076 G-3405 Pump Gasket	54017 G-3269 Valve Gasket	19-2115 O-2082 Drain Plug O-ring
CARTRIDGE FILTER-POLY ELEMENT-FE-095-FE121	3 POSTION VALVE	35-4545 MS-200 Pump Seal
54008 G-5001 Closure Nut Gasket	54017 G-3269 Valve Gasket	35-5030 O-2409 Diffuser O-ring
54067 O-2256 O-ring	54062 O-2133 Valve Stem O-ring	35-5332 O-2172 Lid O-ring
54029 G-4613 Intake Gasket	5 POSTION VALVE	35-4571 O-2195 O-ring (After 11/1/94) <i>Repair/Service Kit Available...See pg. 71.</i>
CARTRIDGE FILTER-1/8 HP POLY ELEMENT-FE039-FE064	54062 O-2133 Valve Rotor Stem O-rng	R SERIES COMMERCIAL HIGH PERFORMANCE PUMP
54005 G-3193 Gasket	54012 G-3122 Valve Gasket	07-5847 O-2389 Lid O-ring
54065 O-2146 O-ring	54040 O-2420 Quad Ring (4)	07-5848 O-2139 Diffuser O-ring
CARTRIDGE FILTER-POLY ELEMENT-FE066	OLYMPIC	07-1725 MS-360 Pump Seal
54065 O-2146 O-ring	WIDE MOUTH SKIMMER	07-4629 G-4386 Gasket
SAND FILTER-1/8 HP-FS643, FS-567	WP-83W G-4056 Widemouth Gasket	WATERFALL PUMP
54005 G-3193 Gasket	PAC FAB	35-4545 MS-200 Pump Seal
54007 G-3235 Gasket	CHALLENGER PUMP	35-5331 O-2015 Diffuser O-ring
54027 G-4218 Tank Gasket	19-2115 O-2082 Drain Plug O-ring	35-5329 G-5061 Front Housing O-ring
54023 G-3190 Gasket	35-4545 MS-200 Pump Seal	19-2115 O-2082 Drain Plug O-ring
54021 G-3195 Gasket	35-5030 O-2409 Medium Head Diffuser O-ring	35-5330 O-2226 Strainer Pot Flg O-ring
54006 G-3194 Gasket	35-5329 G-5061 Front Housing Square Ring-New Style	19-2115 O-2082 Drain Plug O-ring
54017 G-3269 Valve Gasket	35-5329 O-2046 Front Housing O-ring- Old Style	35-5332 O-2080 Lid O-ring
SAND FILTER-15" TANK-FS619, FS620, FS719, FS720, FTA11, 72902	35-5330 O-2226 Strainer Pot Flg. O-rng	CARTRIDGE FILTER-CLEAN & CLEAR PLUS-POLYPROPYLENE-240, 320, 420, & 520 SQ. FT. MODELS
54007 G-3235 Gasket	35-5331 O-2015 High Head Diff. O-r	39010200 O-1141 Clamp O-ring
54023 G-3190 Gasket	35-5332 O-2172 Lid O-ring (Old Style)	86006900 O-2150 Lower Bulkhead O-r
54021 G-3195 Gasket	35-5332 O-2080 Lid O-ring (New Style)	86300500 G-4458 Drain Cap Gasket
54006 G-3194 Gauge Adapter Gask	27-4494 O-2002 Union O-ring	51005000 O-2068 Drain Plug O-ring
54017 G-3269 Valve Gasket	15-2509 G-5079 Square Ring	192320 O-2215 Upper Bulkhead O-r
SAND FILTER-FS369, FS739, FTA12, 72904 (15") & FS570, FS770, 72909 (18")	<i>Repair/Service Kit Available...See pg. 71.</i>	86006900 O-2150 Upper Bulkhead O-r
54007 G-3235 Gasket	COMMERCIAL R SERIES PUMPS-5-15 HP	CARTRIDGE FILTER-MITRA-MA 60, 80, 100, 160
54021 G-3195 Gasket	07-1725 MS-360 Pump Seal	15-4661 O-2141 Air Bleeder Adapter O-ring
54027 G-4218 Tank Gasket	07-4629 G-4386 Gasket	15-4492 O-2282 2" Bulkhead O-ring
54023 G-3190 Gasket	DYNAMITE & DYNATRON PUMPS	15-4538 G-4324 Bulkhead Diffuser Gasket
54012 G-3122 Valve Gasket	35-4545 MS-200 Pump Seal	27-4494 O-2002 Bulkhead Adapter O-r
	35-4533 O-2139 Housing O-ring	31-3225 O-1070 11" Tank O-ring
	35-4571 O-2195 Adapter O-ring	15-4693 O-2376 Knob O-ring <i>O-ring/Gasket Kit Available...See pg. 74.</i>

EQUIPMENT CROSS REFERENCE

FITS	OEM#	SSC#	DESCRIPTION
CARTRIDGE-MYTILUS FMY 80/100/150 & 60/80/100 PLASTIC			
15-4492	O-2282	2"	Bulkhead O-ring
15-4538	G-4324		Bulkhead Diff. Gask.
15-4661	O-2141		Air Bleeder Adapt O-r
17-4704	O-1048		Tank O-ring
27-4494	O-2002		Bulkhead Adapter O-r
15-4693	O-2376		Knob O-ring
<i>O-ring/Gasket Kit Available...See pg. 74.</i>			
CARTRIDGE FILTER-MYTILUS B SINGLE CARTRIDGE			
15-4661	O-2141		Air Bleeder Adapt O-r
17-4704	O-1048		Tank O-ring
19-1424	O-2071		Bottom Piping O-ring
19-1474	O-2115		O-ring
<i>O-ring/Gasket Kit Available...See pg. 74.</i>			
CARTRIDGE FILTER-SEA HORSE-STAINLESS STEEL-SH 300, SH 400, SH 500			
15-2127	O-1062		Tank O-ring
15-4492	O-2282	2"	Bulkhead O-ring
15-4493	O-2041	6"	Adapter O-ring-Fiberglass
19-2320	O-2215		Bulkhead O-ring
27-4494	O-2002		O-ring
27-3513	O-2302		Bleeder O-ring
19-2323	O-2106		O-ring
CARTRIDGE FILTER-SEA HORSE-FIBERGLASS-FSH 300, FSH 400, FSH 500			
15-4492	O-2282	2"	Bulkhead O-ring
15-4661	O-2141		Air Bleeder & Adapter O-ring
19-2320	O-2215		Bulkhead O-ring
19-2323	O-2106		O-ring
27-4494	O-2002		O-ring
27-3513	O-2302		Bleeder O-ring
19-5008	O-1037		Tank O-ring
15-4493	O-2041		O-ring
D.E. FILTER-NAUTLIUS-STAINLESS STEEL, FIBERGLASS			
15-2127	O-1062		Tank O-ring
15-4492	O-2282	2"	Bulkhead O-ring
15-4493	O-2041		Adapter O-ring-Fiberglass
15-4661	O-2141		Air Bleeder Adapt O-r
19-5007	O-2219		Adapter O-rng-Fibergl
19-2320	O-2215		Bulkhead O-ring
19-2323	O-2106		O-ring
19-5008	O-1037		Tank O-ring-Fiberglas
27-4494	O-2002		Valve Adapter O-ring-Fiberglass
27-3513	O-2302		Bleeder O-ring
<i>O-ring/Gasket Kit Available...See pg. 74.</i>			
D.E. FILTER-NAUTILUS-POLYMERIC 24, 36, 48			
27-3513	O-2302		Bleeder O-ring
15-4492	O-2282		O-ring
15-4693	O-2376		Knob O-ring
27-3514	O-2303		Float O-ring
19-2323	O-2106		O-ring
19-5310	O-1100		Tank O-ring
19-2320	O-2215		Bulkhead O-ring
27-4494	O-2002		O-ring
15-4661	O-2141		Bleeder Adapter O-rng

FITS	OEM#	SSC#	DESCRIPTION
D.E. FILTER-STAR			
15-5064	O-2189		O-ring-After 11/89
17-4704	O-1048		Tank O-ring
19-1424	O-2071		Bottom Piping O-ring
19-1474	O-2115		O-ring-After 11/89
19-1479	O-2256		O-ring-After 11/89
27-3011	O-2024		O-ring
15-5564	O-2189		O-ring
<i>O-ring/Gasket Kit Available...See pg. 74.</i>			
D.E. FILTER-TURBO			
15-4492	O-2282	2"	Bulkhead O-ring
15-4661	O-2141		Air Bleeder Adapt O-r
17-4704	O-1048		Tank O-ring
19-2323	O-2106		O-ring
27-3062	O-2040		O-ring
27-4494	O-2002	2"	Bulkhead O-ring
SAND FILTER-P.F. 35, 50, 100 STAINLESS STEEL			
15-2038	O-1056	22"	Tank O-ring
15-2127	O-1062	18"	Tank O-ring
15-2235	O-1071	16"	Tank O-ring (100)
15-4661	O-2141		Air Bleeder Adapt O-r
15-4491	O-2100	1 1/2"	Bulkhead O-rng
15-4492	O-2282	2"	Bulkhead O-ring
15-4538	G-4324	2"	Bulkhead O-r (100)
15-4539	G-4296	1 1/2"	Bulkhead O-rng
15-4693	O-2376		Knob O-ring
15-2038	O-1087	22"	Tank O-ring(PF50)
<i>O-ring/Gasket Kit Available...See pg. 74.</i>			
SAND FILTER-SAND DOLLAR			
19-2115	O-2082		Drain Plug O-ring
27-2708	O-2059		Valve Body O-ring
SAND FILTER-TAGLEUS			
15-4493	O-2041		Valve Body O-ring
15-5064	O-2189		Standpipe O-ring
19-2115	O-2082		Drain Plug O-ring
27-2708	O-2059		Valve Body O-ring
35-5330	O-2226		Standpipe O-ring
27-2541	O-2292		Valve Body O-ring
15-4494	G-5076		Square Ring
27-5333	O-2091		Valve Body O-ring
<i>O-ring/Gasket Kit Available...See pg. 74.</i>			
SAND FILTER-TRION			
15-4492	O-2282	2"	Bulkhead O-ring
15-4493	O-2041		Closure O-ring
15-4538	G-4324	2"	Bulkhead Gasket
15-4661	O-2141		Air Bleeder Adapt O-r
19-2115	O-2082		Drain Plug O-ring
27-4494	O-2002		Valve Adapter O-ring
35-4053	O-2041		O-ring
15-4693	O-2376		Knob O-ring
SAND FILTER-TRITON II			
15-4661	O-2141		Air Bleeder Adapter O-ring
15-4495	O-2041		Closure O-ring
15-4492	O-2282	2"	Bulkhead O-ring
15-4538	G-4324	2"	Bulkhead Gasket
15-4492	O-2282		O-ring
19-2115	O-2082		Drain Plug O-ring
27-4494	O-2002		Valve Adapter O-ring

FITS	OEM#	SSC#	DESCRIPTION
SAND FILTER-TRITON C-3 FIBERGLASS			
27-3513	O-2302		Air Bleeder Screw O-r
27-4494	O-2002		O-ring
15-4005	O-2114		O-ring
15-4004	O-2283		O-ring
27-4494	O-2002		O-ring
1 1/2" 6 WAY TOP MOUNT VALVE			
27-2511	O-2261		Diverter Shaft O-ring
35-4053	O-2041		Valve Top O-ring
27-3513	O-2302		Bleeder O-ring
27-2541	O-2292		Valve Body O-ring
27-1106	G-4362		Sight Glass Gasket
15-4493	O-2041		O-ring
35-4571	O-2195		Adapter O-ring
1 1/4" 4 WAY VALVE-FOR SAND DOLLAR			
27-2707	O-2253		O-ring
27-2708	O-2059		O-ring
2" HI-FLOW DIAL-TROL VALVE-26-1049			
27-2406	O-2124		Diverter O-ring
27-4494	O-2002		Adapter O-ring
2" PVC SLIDE VALVE-26-1165			
27-3060	O-2090		Shaft O-ring
27-3062	O-2040		Cap O-ring
27-3059	G-5114		Piston Gasket
27-3090	O-2068		O-ring
27-2406	O-2124		O-ring
<i>Repair/Service Kit Available...See pg. 71.</i>			
1 1/2" BACKWASH VALVE-BRASS			
27-3097	G-3271		Cap Gasket
27-3060	O-2090		Shaft O-ring
27-3160	G-5112		Piston O-ring (2)
2" BACKWASH VALVE-BRASS			
27-3097	G-3271		Cap Gasket
27-3059	G-5114		Piston O-ring (2)
27-3060	O-2090		Shaft O-ring
1 1/2" MULTIPOINT VALVE-TOP MOUNT, SIDE MOUNT			
27-1103	O-2025		Cover O-ring
27-1162	O-2256		Valve Stem O-ring
27-1104	G-5106		1 1/2" Diverter Gasket
27-1106	G-4362		Sight Glass Gasket
27-2708	O-2059		Valve Adapter O-ring
15-4493	O-2041		Adapter O-ring
27-4494	O-2002		O-ring (2)
2" MULTIPOINT VALVE-TOP MOUNT, SIDE MOUNT			
27-1151	O-2374		Cover O-ring
27-1162	O-2256		Valve Stem O-ring
27-1106	G-4362		Sight Glass Gasket
27-5333	O-2091		Valve Body O-ring
27-4494	O-2002		Adapter O-ring (2)
15-2501	O-2217		Adapter O-ring
FULL FLOW VALVE			
19-2039	O-2220		O-ring
27-5300	O-2332		O-ring
27-4494	O-2002		Adapter O-ring (2)
SKIMMER			
51-3033	G-3267		Face Plate Gasket-Skim Clean

EQUIPMENT CROSS REFERENCE

FITS		
OEM#	SSC#	DESCRIPTION
D.E. FILTER-2000 SERIES STAINLESS-SMBW 2024, 2035, 2048, 2060, 2072, 1018, 1027, 1036, 1045, 1054		
71435	O-2124	Rotor Shaft O-ring
71426	O-2165	Collar Rotor O-ring
71428	O-2220	Brass Rotor O-ring
70952	G-3175	Lid Air Relief Gasket
73270	O-1154	Filter Tank O-ring
35-4535	O-2214	Valve Body O-ring
35-5330	O-2226	Collar Rotor O-ring

SAND FILTER-TAHITIAN-HR-21, 25, 31		
71426	O-2165	Adapter O-ring
71434	O-2221	Rotor Shaft O-ring
71448	O-2034	Valve Body O-ring
<i>O-ring/Gasket Kit Available...See pg. 74.</i>		

TAHITIAN VALVE		
71448	O-2034	Valve Body O-ring
71434	O-2221	O-ring
71426	O-2165	O-ring

BACKWASH VALVE-2000 SERIES		
71427	O-2209	O-ring
71435	O-2124	Rotor Shaft O-ring-Noryl
71428	O-2220	Rotor Shaft O-ring-Brass
71426	O-2165	Collar & Rotor O-ring (2)

ORTEGA VALVE		
72555	O-2024	Shaft O-ring
72553	O-2030	1 1/2" Cover O-ring
72554	O-2044	2" Cover O-ring

ORTEGA 3-PORT BRASS & CPVC VALVES-WITH BRASS OR NORYL DIVERTERS		
72555	O-2024	Shaft O-ring
72553	O-2030	1 1/2" Cover O-ring
72554	O-2044	2" Cover O-ring

ORTEGA II MOTORIZED VALVES-2 & 3 PORT		
71436	O-2090	Shaft O-ring
72555	O-2024	Shaft O-ring (2)
72553	O-2030	1 1/2" Cover O-ring
72554	O-2044	2" Cover O-ring
75114	G-4624	1 1/2" Valve Gasket

RAINBOW		
VACUUM-CONCORDE		
37121	O-2324	Plate O-ring
37009	O-2326	Motor Housing O-ring

CARTRIDGE FILTER-DYNAMIC SERIES I		
17-2224	O-2135	Valve O-ring
17-2223	O-2095	Lid O-ring
17-2222	G-4337	Cartridge Gasket
<i>O-ring/Gasket Kit Available...See pg. 74.</i>		

CARTRIDGE FILTER-DYNAMIC SERIES II & III		
17-2221	O-2135	O-ring
17-2222	G-4337	Cartridge Gasket
17-2223	O-2095	O-ring
17-2393	O-2082	O-ring
17-2451	O-2087	O-ring
33017	O-2141	Control Valve O-ring (2)

FITS		
OEM#	SSC#	DESCRIPTION
FEEDERS-IN LINE-310, 312, 320		
17-2009	O-2114	Cap O-ring
17-2009	O-2522	Cap O-ring-Viton
17-2033	G-4327	Saddle Gasket
17-2319	O-2112	Bottom In-Line O-ring

FEEDERS-FREE STANDING-300, 302, 300-19, 300-29, 300-29X		
17-2009	O-2114	Cap O-ring
17-2009	O-2522	Cap O-ring-Viton
17-2263	G-4393	1/2" Saddle Gasket
17-2033	G-4327	3/4" Saddle Gasket

FEEDER-BROMINE IN-LINE 322		
17-2009	O-2114	Cap O-ring
17-2009	O-2522	Cap O-ring-Viton
17-2319	O-2112	Bottom In-Line O-ring

FEEDERS-HIGH CAPACITY AUTOMATIC-HC-3315, 3330, 3340		
17-2221	O-2135	Vent Valve O-ring
17-2223	O-2095	Lid to Housing O-ring

RICHARDSON/SEABLUE		
SAND FILTER-S/S, FIBERGLASS SIDE MOUNT		
5099-149	O-2278	O-ring
5099-525	O-2152	1 1/2" Valve Adapter O-ring
5099-518	G-5064	Gasket
5099-504	G-4395	Air Bleeder Gasket
5099-125	O-1152	18" Tank O-ring
5099-135	O-1076	22" Tank O-ring

SAND FILTER-FIBERGLASS TOP MOUNT		
5535-101	O-2058	O-ring
5099-518	G-5064	Gasket

CARTRIDGE FILTER-DYNAPURE		
4546-001	O-1153	O-ring

SEASON MASTER		
SKIMMER		
SMS-1094G	G-4001	Face Plate Gasket (2)
SMS-1023G	G-4290	Wall Fitting Gasket Set

SONFARREL (MARTEC)		
POOL MASTER PUMP		
320-102	O-2167	Lid O-ring
700-103	O-2195	Union O-ring
201-002	O-2220	Bleed Plug O-ring
320-108	G-4033	Square Flange Gasket
320-110	O-1082	Volute Housing O-ring
320-119	MS-201	Pump Seal

SPA MASTER AND H&L ASSEMBLY		
320-102	O-2167	6" Lid O-ring
700-103	O-2195	1 1/2" Union O-ring
201-010	O-2024	Plug O-ring
300-004	O-2025	Face Plate O-ring
300-009	MS-1000	Pump Seal

FITS		
OEM#	SSC#	DESCRIPTION
CARTRIDGE FILTER-IC & IF, TS & TT		
201-002	O-2220	Shaft O-ring
201-044	O-2041	Filter O-ring
201-010	O-2024	O-ring

CARTRIDGE FILTER-SS, ST, SK SUCTION		
201-004	O-2041	Filter O-ring

CARTRIDGE FILTER-LARGE CAPACITY TOP LOAD		
205-104	O-2024	O-ring
205-106	O-2294	Bleed Plug O-ring

SPECK		
BADUJET MODEL 21-80-WITH BS HAIR & LINT POT		
2920141230	O-2220	Filler Plug O-ring
2923541220	O-2024	Drain Plug & Shaft O-ring
2923441200	O-2221	Casing O-ring
2923141000	G-4448	Gasket
2991500001	O-2381	Bearing O-ring (Prior 1/86)
2920941210	O-2293	Lid O-ring (Prior 1/95)

MODEL 90 PUMP		
2921141210	O-2304	Lid O-ring
2920141240	O-2141	Plug O-ring
2920141210	O-2071	Diffuser O-ring
2921141220	O-2307	Casing O-ring

STA RITE / SWIMQUIP		
ABG PUMP		
35505-1438	O-2266	Seal Plate O-ring
37400-027S	MS-851	Pump Seal
35505-1437	O-2086	Trap Lid O-ring
AJ, PE, PEA PUMPS		
U109-358SS	MS-100	Pump Seal
U9-228	O-1082	Clamp O-ring
U9-226	O-2195	Diffuser O-ring
C20-79	G-3226	Seal Plate Gasket
<i>Repair/Service Kit Available...See pg. 72.</i>		

CC PUMP		
C20-19	G-3240	Flange Gasket
C20-77	G-3261	Pump Gasket
U109-220	MS-381	Pump Seal
U9-171	O-2107	8" Lid O-ring
U9-265	O-2271	Shaft O-ring
C20-101	G-3197	Seal Gasket
C20-100	G-3199	Gasket

CF PUMP		
C20-72	G-3256	Head Gasket
U109-136	MS-1000	Pump Seal
U9-046	O-2167	Lid O-ring
U9-161	O-2218	5" Lid O-ring
C110-17	E-6502	Pump Shaft Extension
<i>Repair/Service Kit Available... See pg. 72.</i>		

EQUIPMENT CROSS REFERENCE

FITS OEM# SSC# DESCRIPTION	FITS OEM# SSC# DESCRIPTION	FITS OEM# SSC# DESCRIPTION	
CK, CRA4 PUMPS			
N20-26 G-3236 Seal Plate Gasket-Low Heads	C20-19 G-3240 Str to Volute Gasket	35505-1317 O-2100 Cap O-rg (All Models)	
N20-35 G-3259 Seal Plate Gasket-High Heads	C20-72 G-3256 Volute to Motor Gask	35515-1296 O-2403 Outlet Elbow O-ring (All Models)	
U109-93 MS-100 Pump Seal	U109-136 MS-1000 Pump Seal	24751-5 O-1009 Tank O-ring (DEP51, HRP24)	
U9-45 O-2099 Lid O-ring	U9-45 O-2099 4" Lid O-ring	24752-5 O-1046 Tank O-ring (DEP83, HRP30)	
C69-2 G-4253 Slinger Gasket	U9-46 O-2167 6" Lid O-ring	24750-5 O-1106 Tank O-ring (DEP36, HRP20)	
L21-1 G-5034 Diffuser O-ring	U9-161 O-2218 5" Lid O-ring	<i>O-ring/Gasket Kit Available...See pg. 75.</i>	
CENTRIFUGAL PUMP-CSPH, CCSPH			
S04757 G-3412 Volute to Bracket Gsk	U9-229 O-2060 Trap Cover O-rg(HPA)	D.E. FILTER-DEPB 36, 51, 83	
33455-8044 G-3409 Impeller to Shaft Sleeve Gasket	C20-123 G-4441 Strainer to Volute Gasket-Rubber	35505-1317 O-2100 O-ring	
33455-8043 G-3408 Impeller to Washer Gasket	JWPA PUMP		
33450-8042 G-3410 Volute Discharge Gsk	U9-266 O-2195 O-ring	24750-0006 O-1151 Tank O-rng (DEPB 20)	
33450-8041 G-3411 Volute Suction Gask.	U109-358 MS-380 Pump Seal	24751-0006 O-1155 Tank O-rng (DEPB 24)	
D PUMP			
C20-46 G-3164 Gasket	U9-357 O-2266 Front Plate O-ring	24752-0006 O-1156 Tank O-rng (DEPB 30)	
U109-220 MS-381 Pump Seal	C20-123 G-4441 Gasket	35515-1296 O-2403 O-ring	
U9-265 O-2271 Shaft O-ring	JW & JWA5 PUMPS		
C20-100 G-3199 Gasket	U9-226 O-2195 O-ring	D.E. FILTER-STAINLESS DES 25-01B, 36-01B, 5-01B, 60-01B	
DURA GLAS PR, P2R, PRA, P2RA & MAX-E-GLAS PE, PEA PUMPS			
C20-19 G-3240 Tank Body/Trap Gasket-Fiber	U109-358 MS-380 Pump Seal	24700-0068 O-1133 Tank O-ring (25-01B)	
C20-19 G-4411 Tank Body/Trap Gasket-Rubber	U9-357 O-2266 Front Plate O-ring	24700-0072 O-1015 Tank O-ring (36-01B)	
U109-93 MS-100 Pump Seal	LT PUMP		
U9-226 O-2195 Diffuser O-ring	C20-031 G-4412 Head Gasket	24700-0073 O-1002 Tank O-ring (60-01B)	
U9-228 O-1082 Pump Clamp O-ring	U109-68 MS-163 Pump Seal	D.E. FILTER-SYSTEM 3-S7D75, S8C110	
U9-229 O-2060 Lid O-ring	PLBC SERIES PUMP-PLBC-149L, PLBC-178L, PLBCL 1/2 HP		
16920-0012 O-2095 O-ring For 6" Trap	U9-389 O-1011 O-ring	35505-1423 O-2092 O-ring	
<i>Repair/Service Kit Available...See pg. 72.</i>			
DURA-GLAS II P4R, P4RA & MAX-E-GLAS II P4E, P4EA, P4EAA PUMPS			
U9-376 O-2142 Seal Insert O-ring	U109-93SS MS-100 Pump Seal	U9-362 O-2111 Adapter O-ring	
35505-0422 O-1082 Seal Plate O-ring	U9-199 O-2231 Diffuser O-ring	35505-1425 O-2114 O-ring	
U9-374 O-2002 Diffuser O-ring	L20-40 G-4620 Gasket	35505-1424 O-2002 O-ring	
U9-375 O-2247 Trap Cover O-ring	CARTRIDGE FILTER-STAINLESS-T SERIES/ POSIFLO		
35505-1426 O-2386 Impeller Screw O-ring	WC9-3 O-1010 Tank O-ring	D.E. FILTER-SYSTEM 3 MODULAR MEDIA & MODULAR D.E.-PLM100, 150-MOD MEDIA, PLD50, 70-MOD D.E.	
<i>Repair/Service Kit Available...See pg. 72.</i>			
DYNA GLAS & DYNA-MAX PUMPS-3/4 THRU 2 HP			
U9-358SS MS-201 Pump Seal	U9-301 O-2047 Top O-ring	27001-0061S O-2086 Cord O-ring (3/97 - Present)	
U9-374 O-2002 Diffuser O-ring	CARTRIDGE FILTER-POSIFLO&POSIFLO II		
U9-375 O-2247 Lid O-ring	WC9-3 O-1010 Tank O-ring	27001-0060S O-1157 Cord O-ring (Pre 3/97)	
U9-373 O-2305 Seal Plate O-ring	31935-0001 O-2046 Lid O-ring-70, 100, 135 Sq. Ft.	35505-1424 O-2002 O-ring	
33455-1047 G-5072 Impeller Screw Gask	U9-359 O-2024 Air Release O-ring-135 Sq. Ft.	SAND FILTER-CRISTOL FLO-T-170BP, T-200BP, T-240BP, T-300BP	
<i>Repair/Service Kit Available...See pg. 72.</i>			
FLO TECH PUMP			
U9-358SS MS-201 Pump Seal	<i>O-ring/Gasket Kit Available...See pg. 74.</i>		
C69-2 G-4253 Water Slinger	CARTRIDGE FILTER-SYSTEM 3-S7M120, S8M150		
U9-374 O-2002 Diffuser O-ring	35505-1423 O-2092 O-ring	SAND FILTER-CRISTOL-FLO HIGH RATE-T-150BP-1, T-170BP-1, T-200BP-1, T-240BP-1, T-300BP	
U9-399 O-2247 Cover O-ring	35505-1428 O-2040 O-ring	U9-369 O-2094 Valve Flange O-ring	
U9-373 O-2305 Seal Plate O-ring	35505-1429 O-2231 O-ring	U9-370 O-2259 Lateral O-ring	
<i>Repair/Service Kit Available...See pg. 72.</i>			
CARTRIDGE FILTER-TXC25B, TXC50B, TXC75, TXC100			
U9-358SS MS-201 Pump Seal	35505-1424 O-2002 O-ring	U9-371 O-2134 Drain Cap O-ring	
C69-2 G-4253 Water Slinger	35505-1425 O-2114 O-ring	U9-226 O-2195 Union Coupling O-ring	
U9-374 O-2002 Diffuser O-ring	U9-362 O-2111 Adapter O-ring	SAND FILTER-HIGH RATE-HRS16-01, HRS20-01, HRS24-01	
U9-399 O-2247 Cover O-ring	CARTRIDGE FILTER-SYSTEM 3 MODULAR MEDIA-PLM100 & PLM150		
U9-373 O-2305 Seal Plate O-ring	27001-0061S O-2086 Cord O-ring	24700-068 O-1133 O-ring (HRS16-01)	
<i>Repair/Service Kit Available...See pg. 72.</i>			
CARTRIDGE FILTER-TXC25B, TXC50B, TXC75, TXC100			
35505-1157 O-2102 O-ring	35505-1424 O-2002 O-ring	24700-0072 O-1015 O-ring (HRS20-10)	
WC9-11 O-1059 Seal Ring	SAND FILTER-MODELS HRP20, 24, 30		
<i>O-ring/Gasket Kit Available...See pg. 74.</i>			
SAND FILTER-HIGH RATE-HRS16-01, HRS20-01, HRS24-01			
24700-068 O-1133 O-ring (HRS16-01)	24750-5 O-1106 20" Tank O-ring		
24700-0072 O-1015 O-ring (HRS20-10)	24751-5 O-1009 24" Tank O-ring		
24700-0073 O-1002 O-ring (HRS24-01)	24752-5 O-1046 30" Tank O-ring		
SAND FILTER-MODELS HRP20, 24, 30			
24750-5 O-1106 20" Tank O-ring	35515-1296 O-2403 Valve Connection O-rg		
24751-5 O-1009 24" Tank O-ring	35505-1317 O-2100 1 1/2" Bulkhead O-ring		
24752-5 O-1046 30" Tank O-ring			
35515-1296 O-2403 Valve Connection O-rg			
35505-1317 O-2100 1 1/2" Bulkhead O-ring			

EQUIPMENT CROSS REFERENCE

FITS			FITS			FITS		
OEM#	SSC#	DESCRIPTION	OEM#	SSC#	DESCRIPTION	OEM#	SSC#	DESCRIPTION
SAND FILTER-HRPB 20, 24, 30			VICO			WET INSTITUTE		
35505-1317	O-2100	1 1/2" Bulkhead O-ring	BIG FOOT PUMP			WA PUMP		
24750-0006	O-1151	Tank O-ring (HRPB20)	PPULPLUG	O-2024	Plug O-ring	34-050-303	O-2247	Lid O-ring
24751-0006	O-1155	Tank O-ring (HRPB24)	PPBFV/OR	O-2209	Pump O-ring	34-050-309	G-3207	Trap to Volute Gasket
24752-0006	O-1156	Tank O-ring (HRPB30)	PPUFSEAL	MS-201	Pump Seal	34-050-312	O-2026	Bracket O-ring
35515-1296	O-2403	O-ring	WOW PUMP			D.E. FILTER		
SAND FILTER-SYSTEM 3-S7550, S8S70			PPSFSEAL	MS-201	Pump Seal	32-050-715	O-1061	18" Tank O-ring
35505-1423	O-2092	O-ring	PPWWVO/R	O-2005	Volute O-ring	WMC		
35505-1424	O-2002	O-ring	WATERCO			AT SERIES PUMP		
35505-1425	O-2114	O-ring	TURBOTUF, TURBOTUF E, HYDROSTORM PUMP			AT-1600-S	O-1226	Strainer Cover Gask
SAND FILTER-WATERFORD SYSTEM-JSAL15, JSAL17, JSAL20, 24200, 24201, 24203			634002	O-2167	H/L Pot Lid O-ring	SS-1600-R	O-2618	Diffuser Gasket
U9-369	O-2094	Tank Flange O-ring	634017	O-2146	Mounting Bracket O-rng	SS-1600-Z-2	MS-201	Pump Seal
U9-371	O-2134	Drain Cap O-ring	634011	O-2100	Diffuser Gasket	SS-1600-T	O-1209	Housing Gasket
U9-370	O-2259	Lateral Tube O-ring	6340113	O-2117	Diffuser O-ring	JS SERIES PUMP		
1 1/2" MULTIPOINT SIDE MOUNT 14964 & TOP MOUNT 14962 VALVE			6340241	O-2002	Union O-ring	JS-1505R	O-2195	Union O-ring
35505-1228	O-2255	O-ring	SUPATUF PUMP			JS-1701	O-2041	Housing Gasket-Center Discharge
35505-1272	O-2189	O-ring	635028	O-2214	Body O-ring	JS-3701	O-2025	Housing Gasket-Side Discharge
14962-0021	G-5012	Square Ring	634016	MS-601	Pump Seal	JS-1702	MS-200	Pump Seal
1 1/2" MULTIPOINT VALVE-WC112 SERIES-FOR CRISTOL-FLO & WATERFORD			63151	O-2167	H/L Pot O-ring	JS-1903	O-2095	Strainer Cover O-ring
35505-1228	O-2255	Diverter O-ring	6340241	O-2002	50MM Union O-ring	HYDRON SAND FILTER		
35505-1275	O-2209	Cover O-ring	WATERMATIC			62100	O-2266	Neck O-ring
U9-369	O-2094	Valve Flange O-ring	G-1000 FEEDER			621457	O-2264	Axle O-ring
1 1/2" (14821) & 2" (14826) BRONZE SLIDE VALVE			1-020	G-4451	Rain Cover Gasket	621462	O-2242	Sight Glass O-ring
35505-1116	O-2082	O-ring	1-190	G-4602	Collar Gasket	<div style="border: 2px solid black; border-radius: 15px; padding: 10px;"> <p>Please Note: This is only a partial list of the parts we offer. Please refer to the OEM Part# Cross Reference section (pg. 13) for many more listings</p> </div>		
35505-1401	O-2042	1 1/2" Unitrol O-ring	1-110	G-4389	Hopper Lid Gasket			
35505-1313	O-2134	2" Unitrol O-ring	1-370	G-4456	Cross Pump Bracket Gasket			
U9-362	O-2111	O-ring	WATERWAY					
2" MULTIPOINT VALVE-SIDE MOUNT-WC-212-150P			A.G. / SPA PUMP-CENTER DISCHARGE					
U9-243	O-2067	Cover O-ring	805-0014	O-2082	Drain Plug O-ring			
U9-244	O-2110	O-ring	805-0252	O-2025	Faceplate O-ring			
WC9-2	G-4387	Sight Glass Gasket	811-1001AB	MS-1000	Pump Seal			
U9-362	O-2111	Union O-ring (2)	A.G. / SPA PUMP-SIDE DISCHARGE-HI-FLO, SUPER-FLO MODELS					
2" MULTI-PORT VALVE-SIDE MOUNT-14971-0012, WC212-38, WC212-144P			805-0014	O-2082	Plug O-ring			
35505-1412	O-2297	O-ring	805-0256	O-2041	Volute O-ring			
35505-1223	O-2239	O-ring (2)	811-1001AB	MS-1000	Pump Seal			
14971-0011	G-4619	Sight Glass Gasket	CARTRIDGE FILTER-TOP LOAD					
OLD STA RITE SLIDE VALVE			715-1001	O-2133	Air Relief O-ring			
U9-147	O-2024	Cap O-ring-Internal	805-0360	O-2095	Filter Top O-ring			
U9-152	O-2134	2" Piston Cap Assembly O-ring	805-01205D	O-2053	O-ring			
U9-174	O-2142	1 1/2" Piston Cap Assembly O-ring	<i>O-ring/Gasket Kit Available...See pg. 75.</i>					
PLASTIC SLIDE VALVE			CARTRIDGE FILTER-1 1/2" & 2" IN-LINE					
35505-1246	O-2280	O-ring	805-0114	O-2133	Air Relief O-ring			
35505-1318	O-2010	O-ring	805-0360	O-2095	Filter Top O-ring			
U9-362	O-2111	O-ring	CARTRIDGE & D.E. FILTER-CLEARWATER-D.E. MODELS FD044, FD067, FD090; CARTRIDGE MODELS FC075, FC100, FC150					
35505-1116	O-2082	Shaft O-ring	805-0383	O-2388	O-ring			
SEPARATION TANK-THERMOPLASTIC-60SEP			SAND FILTER-CLEARWATER-FS016 (16"), FS019 (19"), FS022 (22")					
U9-359	O-2024	O-ring	711-1920	G-4609	Gasket			
31935-0001	O-2046	O-ring						
WC9-3	O-1010	O-ring						

OEM PART# CROSS REFERENCE

FITS			FITS		
OEM#	SSC#	DESCRIPTION	OEM#	SSC#	DESCRIPTION
A & A MFG.			—	O-2142	Commander 1 1/2" Volute Piston O-ring
820-115	O-2217	Water Valve O-ring	—	O-2222	Air Relief Valve O-ring
A.O. SMITH			—	G-4207	Rubber Washer
23789	G-5022	Spa Element Gasket	—	G-4237	Olympian Filter Gasket
98198	O-2134	Heater By-Pass O-ring	—	F-8215	Titan Stainless Steel DE Filter O-ring Kit
99659	G-4335	Outlet Manifold Gasket	—	F-8316	Commander Cartridge Filter O-ring Kit
99659-1	G-4209	Inlet Manifold Gasket	—	F-8317	Quantum Cartridge Filter O-ring Kit
99660	O-2134	Heater By-Pass O-ring	—	R-6126	Multiport Valve-Before 1976-Repair Kit
ACURA SPA SYSTEMS			—	R-6127	1 1/2" & 2" Bronze & ABS Slide Valve Repair Kit
0163	G-4040	Turbo Blower Cover Gasket	—	R-6128	Multiport Valve-After 1976-Repair Kit
0167	G-4137	Turbo Blower Motor Mount Gasket	—	R-6129	Americana & Bronze Pump Repair Kit
0390	G-3030	Power Quip Heater Gasket	—	R-6130	Eagle Pump Repair Kit
0430	O-2125	Power Quip Heater O-ring	—	R-6143	Ultra Flow & Bronze w/ Bronze Imp. Repair Kit
1058	O-2024	Magna Drain Plug O-ring	—	R-6149	Maxim, Americana II, Power Glas Pump Repair Kit
1059	O-2041	Aquaheat Large Pump O-ring	—	O-2222	Air Relief Valve O-ring
1060	O-2252	Maverick Pump Face Plate O-ring	—	O-2264	Americana Spacemaker O-ring
1061	O-2209	Magna Faceplate O-ring	191016	O-1205	O-ring
1062	O-2226	Magnaflow 2" Union O-ring	192320	O-2159	Clean & Clear Plus Upper Bulkhead O-ring
1081	O-2301	Aquaheat Diffuser O-ring	271151	O-2374	2" P Valve Lid O-ring
1090	MS-1000	Pump Seal	371017	O-2012	Lid O-ring
1660	O-2189	Pump Union O-ring	374058	G-4329	Heater Gasket
ADVANCE			390004	O-2080	Power Pump Lid O-ring
6C-200	MS-200	Pump Seal	390008	G-4120	Power Pump Gasket
6C-201	MS-201	Pump Seal	390022	O-1060	Power Pump Body O-ring
OV-11-006	O-2503	Chlorinator Viton O-ring	390040	O-2195	Diffuser O-ring For Power Pump
OV-11-008	O-2507	Chlorinator Viton O-ring	390060	O-1082	Ultra Flow Pump Volute O-ring
OV-11-009	O-2520	Chlorinator Viton O-ring	390066	O-2111	Ultra Flow Pump Volute O-ring
OV-11-010	O-2521	Chlorinator Viton O-ring	390100	O-2082	Impeller O-ring
OV-11-011	O-2506	Chlorinator Viton O-ring	390102	O-1141	RPM Tank Cover O-ring
OV-11-012	O-2502	Chlorinator Viton O-ring	391015	O-2079	Body O-ring
OV-11-028	O-2505	Chlorinator Viton O-ring	391016	O-2066	Americana II Body O-ring
OV-11-110	O-2508	Chlorinator Viton O-ring	391017	O-2012	Americana II Lid O-ring
OV-11-112	O-2519	Chlorinator Viton O-ring	391019	O-2218	Maxim, Americana II Lid O-ring
OV-11-113	O-2124	Chlorinator O-ring	391028	O-2165	Swivel Union O-ring
OV-11-203	O-2516	Chlorinator Viton O-ring	391029	O-2040	Titan O-ring, Sandpiper O-ring (Current Version)
OV-11-210	O-2515	Chlorinator Viton O-ring	392003	O-2095	Plate to Volute O-ring
OV-11-212	O-2256	Chlorinator O-ring	392014	O-2249	Lid O-ring
OV-11-325	O-2068	Chlorinator O-ring	392014	O-2604	Blue Teflon Coated Lid O-ring
OV-11-332	O-2002	Chlorinator O-ring	392041	O-2060	Eagle Pump Lid O-ring, Filter O-ring
AIRQUATIC			392048	G-4284	Eagle Gasket
5099-149	O-2217	FG Filter Lid O-ring	393003	O-2054	Pump Lid O-ring
ALADDIN			393006	O-2054	Locking Ring Lid O-ring
O-408	O-2122	Vac Master Lid O-ring	395001	G-4285	Noryl Pump Slinger Gasket
ALDEN LEEDS			395001	G-4601	Water Slinger
O-6030	O-2139	Divert-O-Trol Chlorinator O-ring	395004	O-2404	Seal Plate Quad Ring (Prior to 1975)
AMERICAN GRANBY			395005	MS-201	Pump Seal
50-1100BSS	O-2115	1 1/2" Heat Sink O-ring	395012	G-4409	Pot to Volute Pump Gasket
55-1150B55	O-2165	2" Heat Sink O-ring	395013	G-5045	Seal Plate Ring (After 7/75)
AMERICAN PRODUCTS (DIV. OF PENTAIR)			397012	MS-1000	Pump Seal
—	O-1014	Separation Tank O-ring MS6-72	397013	E-6501	Pump/Motor Shaft Extension
—	O-1060	Bottom Seal For Carbide 52/104 Sq. Ft.	397018	O-2026	Pump O-ring
—	O-2008	1 1/2" Collection O-ring	397020	MS-1000	Pump Seal
—	O-2020	Americana Spacemaker Collector O-ring	397028	O-2026	6 3/4" Bronze Pump O-ring
—	O-2024	Separation Tank Air Relief Valve O-ring	421612	O-2262	Power Glass Volute O-ring
—	O-2082	Crank O-ring	422160	G-4221	Power Glass Gasket
—	O-2106	Titan Manifold O-ring	422240	G-4628	Diverter Jet Gasket-2 or 3 Port
—	O-2124	Multiport Valve Rotor Shaft O-ring	423160	O-2129	Super Flo II Cartridge Filter Knob O-ring
—	O-2135	Commander Air Relief O-ring	451170	G-4002	Twin Port Skimmer Sealing Gasket
			453330	G-3141	Pep Main Drain Gasket
			461130	G-4290	2" ID Thick Gasket
			461352	G-4350	Lux Spa Jet Gasket
			467130	O-2090	Diverta Port Valve Bobbin O-ring
			467150	O-2134	Diverta Port Valve Puck O-ring
			467170	O-2165	Diverta Port Valve Cap O-ring
			467220	G-4163	Aqua Fan Gasket
			468155	O-2208	Aqua Lumin Light O-ring

OEM PART# CROSS REFERENCE

FITS OEM#	SSC#	DESCRIPTION
AP-304D	MS-1000	Pump Seal
ANTHONY		
—	O-2008	Piston O-ring
—	O-2093	1 1/2" Old Style Piston Ring
—	O-2100	Rear Seal O-ring
—	O-2106	Bulkhead Connector
—	O-2121	Hydro H&L Lid O-ring
—	O-2203	New Style Piston O-ring
—	O-2240	4" Pump Lid O-ring
—	O-2282	Old Style Light Base O-ring
—	G-3139	Pump Gasket
—	G-4006	Inlet/Outlet Gasket
—	G-4217	Oval Lid Gasket
—	G-4310	Sight Glass Gasket
—	R-6112	1 1/2"&2" Univ. Bronze&ABS Slide Valve Repair Kit
—	R-6154	1 1/2" Brass Slide Valve Repair Kit
04278	O-1014	Separation Tank O-ring
04380	MS-1000	Pump Seal
04382	G-3253	AC, AS Volute Gasket
04387	O-2218	AC2, AS2 5" Strainer Cover O-ring
04412	O-2214	AR Seal Plate O-ring
04465	G-3226	AJ 105 Sweep Pump Gasket
04466	G-3210	Sweep Pump Gasket 105, VB44
04547	MS-100	Pump Seal
06483	O-1014	Separation Tank 40/60 O-ring
11027	O-2087	Conv. Kit O-ring
12382	O-1025	Ditron Tank O-ring
12388	G-4327	SS Ditron Upright Filter Air Release Valve Gasket
14118	O-1216	Double Bead Light Lens Gasket
15029	G-4431	Old Style Rear Header Gasket
15147	G-4005	Dual Housing Heater Gasket
15448	G-4224	Rubber Tube Seal Gasket
15981	G-4025	Inlet/Outlet Heater Gasket
17433	O-1039	18" Tank O-ring
17434	O-1037	A-40 O-ring
17437	O-2024	Valve Shaft O-ring
17438	O-2006	Spinfilter End Bell O-ring
17606	O-2142	1 1/2" Piston & Valve Cap O-ring
17681	O-2231	3/16" Piston & 2" Cap O-ring
17770	R-6111	2" Plastic Slide Valve Repair Kit
17786	O-2188	Plastic Valve Plunger Rod O-ring
17790	O-2106	2" Plastic Valve Union O-ring
17791	O-2004	Brass Push Pull Valve 1.5 O-ring
17792	O-2188	2" Brass Push-Pull Valve O-ring
17810	R-6111	2" Plastic Slide Valve Repair Kit
27111	G-4326	Large Tube Seal Gasket
6527	O-1158	Separation Tank O-ring
HL4	O-2099	4" H&L Trap O-ring
HL6	O-2247	6" Pump Lid O-ring
LL	O-2018	Lens O-ring
U109-93SS	MS-100	Centrifugal Pump Seal
U9-161	O-2218	Centrifugal Pump Trap Cover O-ring
U9-169	O-2214	Seal Plate O-ring
VB27	G-3169	Volute Pump Gasket
AQUA DYNE (SEE LAARS)		
AQUA GENIE (SEE CASCADE)		
AQUA FLO		
—	O-2195	Male Adapter O-ring
—	R-6140	Dominator & C-Before 1995-Pump Repair Kit
—	R-6141	Master & Tubmaster Pump Repair Kit

FITS OEM#	SSC#	DESCRIPTION
—	R-6142	Standard A Series 5" Pump Repair Kit
—	R-6145	Dominator & C-After 1995-Pump Repair Kit
91049000	MS-2131	Pump Seal
91500000	G-3151	AC Series Volute Gasket
91500050	G-3256	A Series 1/3 to 2 HP Volute Gasket, B Series Gask
91500100	G-3220	A Series 3 HP Volute Gasket
91500150	G-3275	A Series 5" Trap Gasket
91500200	G-3240	A Series 6" & 8" Trap Gasket
91500250	G-4407	A Series Drain Gasket
92200000	O-2228	A Series 5" Trap Cover O-ring
92200010	O-2247	A & AC Series 6" Trap Cover O-ring
92200020	O-2032	8" Trap Cover O-ring-AC
92200050	O-2067	C Series Volute O-ring
92200060	O-2141	O-ring
92200070	O-2082	O-ring
92200090	O-2262	FMH Series Volute O-ring
92200100	O-2226	FM, B Series Suction O-ring
92200110	O-2189	FM Series Suction O-ring
92200120	O-2253	Pipe Plug O-ring
92200140	O-2195	O-ring
92200150	O-2252	Volute O-ring
92200160	O-2221	O-ring
92200180	O-1082	O-ring
92200190	O-2128	Dominator Trap Lid O-ring
92200200	O-2025	Flo Master, Tubmaster Volute O-ring
92200210	O-2270	O-ring
92200270	O-2252	FMCP Volute O-ring
92200290	O-2214	FMXP Pump Volute O-ring
92500050	MS-1000	Pump Seal
92500150	MS-200	Pump Seal
92509020	MS-200	Pump Seal
92509040	MS-1000	Pump Seal
ACF-11/915	G-3151	Commercial Volute Gasket
AF-06	E-6502	Pump/Motor Shaft Extension
AF-10	O-2228	5" Lid O-ring
AF-10-01	O-2247	O-ring
AF-11	G-3256	Volute Gasket
AF-11-01	G-3220	3 HP Volute Gasket
AF-12	G-3275	Trap Gasket
AF-12-1	G-3240	3 HP Trap Gasket
AF-14	MS-1000	Pump Seal
CF-11	O-2067	C Series Volute O-ring, Dominator O-ring
FCF-11	O-2041	O-ring
FF-11	O-2262	O-ring
FF-12	O-2226	O-ring
FF-12-02	G-4407	100% Drain Gasket
FF-12-1	O-2189	O-ring
FF-14	MS-200	Pump Seal
FF-14-02	O-2104	Seal Cup O-ring
FF-17-03	O-2195	O-ring
AQUA LEADER		
—	G-4032	Skimmer Face Plate Gasket
—	G-3006K	Skimmer Gasket Kit-2 Sets Totaling 4 Gaskets
AQUA SPORTS		
SMS-1094G	G-4001	Face Plate Gasket (for Kit Order 2)
AQUARIUS		
—	G-3251	Volute Gasket
AQUATHERM		
16-070-200B	MS-1000	Pump Seal
17-051-003	O-2195	O-ring

OEM PART# CROSS REFERENCE

FITS	OEM#	SSC#	DESCRIPTION
AQUAVAC			
78005	G-4062		Tiger Shark Bottom Lid Gasket

ARNESON (DIVISION OF HAYWARD)

A-08	MS-200		Pump Seal
A-40	G-5119		A1, A60 Booster Pump Endbell Gasket
AXL12	G-4162		Main Drain Gasket
D-10	G-5043		Hose Washer
E-43	O-2220		Turbo Sweep Seal Plate O-ring
F-07	O-2082		Pool Sweep O-ring
F-24	O-2135		Backup Extension O-ring
G-12	O-2208		Gear Housing O-ring
G-29	G-3238		Gear Housing Gasket
G-29B	G-3237		Gear Housing Gasket
G-32	O-2263		Lower Bearing O-ring
J-04	O-2144		Valve Body O-ring
K-965	O-2243		Body O-ring
K-966	O-2254		Element O-ring
W-430	O-2011		Leaf Cannister O-ring
W-542	O-2300		Pool Vac O-ring

ASTRAL

00091R0204	O-2254		O-ring
00270R0001	G-4158		Gasket
00273R0001	G-4055		Gasket
00352R0010	G-4605		Compression Ring Gasket
00361R0001	G-4604		Light Gasket
00470R0319	G-4633		Chemical Feeder Drain Gasket
00541R0402	G-4319		Persius Sand Filter Drain Gasket
00541R0404	G-4462		Persius Sand Filter Drain Cap Gasket
00545R0214	G-4295		Gasket
00546R0202	G-4157		Interior Bulkhead Gasket
00600R0001	G-4630		Top Mount M/V Sight Glass Gasket
00612R0001	G-4320		Filter Gasket
00690R0402	G-4156		Sand Filter Drain Gasket
02063	G-4153		Gasket
02064	G-4143		Sand Filter Gasket
02065	G-4154		4" Gasket
02068	G-4155		6" Gasket
103R0003	G-4257		Drain Gasket
11130R0006	G-4631		Offline Chemical Feeder Gasket
1461R0001	G-4049		Skimmer Gasket
15628R9601	MS-1000		Astra Max Seal
271R0002	G-4147		Main Drain Gasket
365R0002	G-4145		Light Gasket
544R0106	G-4392		Gasket
545R0305	G-4144		Bulkhead Gasket
597R0102	G-5106		5 Spoke Spider Gasket
600R0205	G-4383		Valve Plug Gasket
687R0303	G-4146		Sand Filter Gasket
690R0406	O-2224		Sand Filter O-ring
710R0402	O-2224		O-ring
711R1329035	O-2025		Chemical Feeder O-ring
713R0580030	G-4603		Gasket
721R0089019	O-2135		Bolt O-ring
721R0195030	O-2220		Light O-ring
721R180060	O-2032		Persius Sand Filter O-ring
721R1820060	O-2094		Valve Body O-ring
722R0198035	O-2239		O-ring
722R0198036	O-2239		Multiport Valve Rotor Axle O-ring
722R1100110	O-1145		Light O-ring
722R1362035	O-2128		Multiport Valve Lid O-ring
722R1362035	O-2128		Top Mount M/V Lid O-ring
723R0049003	O-2152		Persius Sand Filter O-ring
723R0700050	O-2120		Sand Filter O-ring
7730599035	O-2226		Astra Max O-ring
7731329035	O-2025		Astra Max O-ring
7731520035	O-2011		Astra Max O-ring

FITS	OEM#	SSC#	DESCRIPTION
773R0950050	O-2114		Sand Filter O-ring
773R1450050	O-2266		Sand Filter O-ring
788R4140120	G-4150		Gasket

BAKER HYDRO

—	O-2106		Valve Coupler O-ring
—	O-2223		Newport Valve Shaft O-ring
—	F-8324		Mite Cartridge Filter O-ring Kit
00B7000	O-1210		Control Plate Gasket/O-ring
00B7001	O-2106		Bulkhead Fitting O-ring
00B7013	G-5006		Filter Lid Ring (1969-71)
00B7014	O-2188		Valve Piston O-ring (For Kit Order 3)
00B7015	K-6006		Piston O-ring Kit
00B7026	O-2089		Newport Sand Filter Valve Tank O-ring
00B7027	O-2040		Old Style Bulkhead Adapter O-ring
00B7027	G-5058		New Style Bulkhead Adapter Ring-Square Cut
00B7028	G-5006		Baker II Clamp Ring
00B7031	G-5011		Top Mount Sand Filter Gasket
00B7037	O-1021		Tri-Filter Lid O-ring
15B3315	O-2094		Tank O-ring-16, 20, 24
17B1085	G-4216		Cartridge Filter Gasket
17B1087	O-2095		25 Sq. Ft. Lid O-ring
254760	O-2155		Old Style Spa Pak Pump O-ring
284860	G-4231		Old Spa Pak Pump Slinger Gasket
301560	O-2020		Old Spa Pak Pump Gasket
30C3005	O-2025		1 1/2" Multiport Valve Cover O-ring
30C3009	O-2256		1 1/2" Multiport Valve Shaft O-ring
30C3011	G-5106		1 1/2" Spider Gasket-5 Spoke
30C3015	G-4637		Sight Glass Gasket
30C3018	O-2195		TM 1 1/2" Center Tube O-ring
30C3019	O-2195		1 1/2" Valve Plug O-ring
30C3105	O-2374		2" Multiport Valve Cover O-ring
30C3109	O-2256		2" Multiport Valve Shaft O-ring
30C3115	G-4637		Sight Glass Gasket
30C3119	O-2165		2" Valve Plug O-ring
31B0015	G-4268		Baker Valve Top Plate Gasket
31B0024	K-6006		Piston O-ring Kit
31B0035	O-2082		Index Plate O-ring
31B1107	O-2618		Spa Pak Pump Diffuser Gasket
31B9006	G-4271		Sand Filter Bulkhead Fitting Gasket
34B3147-2-V	MS-1000		Pump Seal
35131138	MS-2131		Pump Seal
35B1108	O-1209		Spa Pak Pump Housing Gasket/O-ring
35B1109	MS-201		Pump Seal
35B1116	G-4227		Spa Pak Pump Slinger Gasket
35B1117	G-5039		Spa Pak Pump Lid Gasket
35B1136	G-3125		Spa Pak Pump Housing Gasket
35B1138	MS-2131		Pump Seal
35B1150	G-4435		Spa Pak Pump Gasket
35B1178	MS-200		Pump Seal
374780	G-5014		Old Spa Pak Pump Gasket
374790	G-5010		Old Spa Pak Pump Gasket
374820	G-5052		Old Spa Pak Pump Gasket
394040	G-5016		Old Spa Pak Pump Gasket
51B1047	G-3010		Skimmer Face Ring Gask (For Kit Order 2)
51B1047	G-3039		Hydro-Pak Face Ring Gasket
MI-29-3	MS-100		Pump Seal

BARACUDA

67600	O-2093		Zippy/Zippy Pure Wall Adapter O-ring
ADG-5	G-4401		Universal Pool Cleaner Floor Gasket

BERKELY

—	O-2109		5" H&L Pot Lid O-ring
---	--------	--	-----------------------

OEM PART# CROSS REFERENCE

FITS OEM#	SSC#	DESCRIPTION
BILNOR		
1743	G-3283	Skimmer Gasket
1750	G-4132	Return Fitting Gasket
1761	G-4133	Return Fitting Gasket
BIO LAB		
25475HYD	O-2228	Brominator Lid O-ring
254840MN	G-4617	Brominator Gasket
5470	G-4327	Tygon Washer
B-94	O-2228	Brominator Lid O-ring
PC25350	O-2524	MA Chlorinator Cover Viton O-ring
BLUE HAVEN		
—	O-2093	1 1/2" Old Style Piston Ring
BLUE WHITE		
9003-003	O-2208	Chlorinator O-ring
9003-009	O-2135	Chlorinator O-ring
9003-011	O-2248	Chlorinator O-ring
9003-016	O-2257	Chlorinator O-ring
9003-020	O-2205	Chlorinator O-ring
9003-024	O-2281	Chlorinator O-ring
9003-030	O-2141	Chlorinator O-ring
9003-051	O-2227	Chlorinator O-ring
9003-058	O-2051	Chlorinator O-ring
9003-067	O-2220	Chlorinator O-ring
C-350	O-2222	Check Ball O-ring
C-502	O-2248	Tube Adapter O-ring
BRETT AQUALINE		
100022K	O-2262	EM203 Pump O-ring
37-0101BK	G-4606	Light System Gasket
60-0001	O-2086	EM103 Heater & Pump O-ring
60-0002	G-4381	Current Collector O-ring
61-0001	G-4344	EM 103 Heater and Pump Gasket
63-0001	G-4397	Current Collection Gasket
BUSTER CRABBE		
20-1040	G-4229	Pump Gasket
C & R		
20-1040	G-4229	Pump Gasket
20-2056	O-2226	2" Union O-ring
CAL FOUNTAIN PUMPS		
—	G-4453	Volute Gasket-No. 3
—	O-2177	Volute O-ring-A180, 210A
10240	O-2324	Volute O-ring-A280, 320, 430-A
11190	O-2215	Volute O-ring-5580, 900, 1220-S
CAPITOL		
G-106	G-4214	Chlorinator Gasket
CARETAKER SYSTEMS (CSI) (HYDROSTORM PUMP)		
1131	O-2310	Large O-ring
1132	O-2189	Small O-ring
1133	O-2282	Union O-ring
413-0501	O-2165	Mounting Bracket O-ring
413-0575	O-2146	3/4-2 HP Diffuser O-ring
413-0620	O-2224	Lid O-ring
413-0640	O-2002	Union Assembly O-ring
634002	O-2167	Hydrostorm Pot Lid O-ring
634011	O-2100	Hydrostorm Pump Diffuser O-ring
6340113	O-2117	Hydrostorm Diffuser O-ring

FITS OEM#	SSC#	DESCRIPTION
634017	O-2146	Hydrostorm Mounting Bracket O-ring
6340241	O-2002	Hydrostorm Union O-ring
CASCADE (AQUA GENIE)		
500010	G-3027	Aqua Genie Faceplate Gasket-Fiber
500010	G-4034	Aqua Genie Faceplate Gasket-Rubber
500011	G-4035	Aqua Genie Oriface Gasket
CHEMTECH		
27903	G-3184	Series 100/200 Gasket
27911	G-3028	Series 200 Motor Housing Gasket
42031	G-3186	Series 200 Gasket-Fiber
CLAYTON		
P-4450	G-4051	Face Plate Gasket
COLECO		
—	G-4405	Hydro Gasket
30483	G-4026	Hydro Skim Gasket
30484	G-4114	Return Fitting Gasket
31954	O-2264	Top O-ring
31992	O-2142	Top O-ring
33185	O-2040	Cover O-ring
33221	O-2266	Pump O-ring
33235	O-2114	Cover O-ring
33236	O-2203	Strainer Inlet O-ring
33510	O-1023	Fiberglass Tank O-ring
34023	G-4309	Gasket
34027	G-4295	Gauge Gasket
37280	G-4405	Hydro Skimmer Float Gasket
38213	G-4043	Skimmer Gasket
COLUMBIA		
—	R-6153	Blue Seal Repair Kit
COMFORTZONE (DIVISION OF HAYWARD)		
CZXGKT7408	G-4452	Bucket Gasket (For Kit Order 2)
CZXGKT9216	G-4626	C-SPA XI Inlet/Outlet Gasket
GKT-1930	G-4021	CZ/HMZ Gasket
GKT-7401	G-4007	Large Bucket Gasket (For Kit also Order G-4018)
GKT-7402	G-4018	Small Bucket Gasket (For Kit Also Order G-4007)
COMPOOL (DIVISION OF PENTAIR)		
OR-4	O-2220	Shaft O-ring
OR-6	O-2175	Cover O-ring
CONGER BROTHERS		
—	O-2116	Mini Air Control O-ring
—	O-2142	Large Air Control O-ring
—	O-2270	O-ring-2 3/4" OD x 1/8" TH
—	O-2256	O-ring- 1 1/8" OD x 1/8" TH
DANNER		
—	O-2009	Model 350 Cover Pump O-ring
DELUXE HEATER		
20-3212	K-6011	O-ring/Gasket Kit
DIACLEAR		
035-3400	G-3282	HPE Diaclear Gasket
35100	MS-163	Pump Seal
35104	MS-142	Pump Seal
36100	MS-142	Pump Seal

OEM PART# CROSS REFERENCE

FITS OEM#	SSC#	DESCRIPTION
8256-11	O-2170	ES-7 Gorman Rupp O-ring
AP-304D	MS-1000	Pump Seal
C-10139	O-2262	MS-16 & MS-18 Cover O-ring
C-10146	O-2201	MS-12 to MS-18 O-ring For C10145
C-30082-MS	O-2099	Strainer Cover O-ring
C-46181	O-1019	ES-7 Cover O-ring
C-46251	G-3205	MS 18 Pump Gasket
DP-46350	O-2177	Slide Valve Cover O-ring

**DOUGHBOY
(SEE LOMART FOR MORE LISTINGS)**

—	MS-2131	Pump Seal
—	R-6131	Power Pak II Pump Repair Kit
—	R-6132	Dynaflow Power Pak I Pump Repair Kit
—	G-4160	New Main Drain Gasket
1128-1006	MS-642	Pump Seal
1128-1006	MS-1000	Pump Seal
306-1002	MS-1000	Pump Seal
306-1005	MS-1000	Pump Seal
306-1006	MS-299	Pump Seal
306-1007	MS-200	Pump Seal
307-1001	G-4425	Gasket
307-1002	G-4131	MX60RP Inlet Fitting Gasket
307-1003	G-3278	Cartridge Gasket
307-1004	G-3212	Cartridge Gasket
307-1005	G-4030	MY205 Skimmer Gasket (For Kit Order 2)
307-1007	G-4305	Skim Filter Drain Cap Gasket
307-1023	G-4220	Deluxe Skimmer 90 Degree Radius Fitting Gasket
307-1027	G-4029	Skim-Line Face Plate Gasket
307-1027	G-4029A	New Style Skimmer Gasket-Wider
308-1000	O-1041	Tank O-ring
308-1001	O-2090	Manifold Seal O-ring
308-1002	O-2255	Lid Bushing O-ring
308-1003	O-2104	Manifold Bearing O-ring
308-1004	O-2240	H&L Pot O-ring
308-1005	O-2017	3/4 HP Pump O-ring
308-1006	O-2134	Piston O-ring
308-1008	O-2226	Valve Body O-ring
308-1009	O-2024	Air Relief Fitting O-ring
308-1010	O-2170	Pump O-ring
308-1011	O-2141	Volute O-ring
308-1012	O-2212	#1110D Tank O-ring
308-1013	O-2205	Pump Discharge O-ring
308-1014	O-2216	1141 & 1162 MY185RP Cartridge O-ring
308-1016	O-2115	Outlet Retainer O-ring
308-1018	O-2401	Manifold Quad Ring
308-1038	O-2041	O-ring
308-1039	O-2152	Hose Adapter O-ring
308-1040	O-2104	Insulator O-ring
308-1044	O-2263	O-ring
308-1046	O-2231	O-ring
308-1052	O-2286	Strainer Body O-ring-1984
308-1054	O-2220	Drain Valve O-ring
308-1056	O-1041	Tank O-ring
308-1059	O-2119	Dynaflow Cover O-ring
308-1061	O-2203	Dynaflow Basket Port O-ring
308-1062	O-2264	Cartridge Filter Coupling O-ring
308-1064	O-2122	O-ring
308-1067	O-2286	Power Pak 2 Lid O-ring
308-1068	G-4043	S-12, 60-4012 Skimmer Gasket
308-1072	G-4425	Gasket
308-1075	O-1012	O-ring
308-1076	G-4250	Gasket
308-1081	G-4201	Valve Cap Gasket
308-1083	G-4202	Gasket
308-1089	G-4042	DIX Skimmer Gasket
308-1099	O-2041	PPI Diffuser O-ring
308-1109	G-4309	Silica Valve Body Gasket/Washer

FITS OEM#	SSC#	DESCRIPTION
308-1110	G-4220	Gasket
308-1113	O-1134	Sand, DE & Silica I Tank O-ring
308-1114	O-1135	Silica II Tank O-ring
308-1115	O-1013	O-ring
308-1124	O-2209	Cyclops Mark 5 O-ring
308-1125	O-2007	Cyclops Strainer Cover O-ring
308-1134	O-2038	Pro X Backwash Valve Cap O-ring
308-1137	O-2146	Lid Bushing O-ring
308-1139	G-4324	Flat Cut Gasket
308-1140	G-5028	2" Inspection Port Ring
308-1141	O-1066	Filter Tank O-ring
308-1142	O-1090	20" Tank O-ring
308-1145	G-4219	Drain to Valve Gasket
308-1146	G-4276	Viewport Lid Gasket
308-1147	G-4241	Viewport Gasket
308-1150	O-2150	O-ring
308-1152	O-2135	Valve Cover Plunger O-ring
308-1156	O-1065	15" Tank O-ring
308-1167	O-2286	Power Pak 2 Lid O-ring
308-1172	G-4161	Main Drain Gasket
308-1174	O-2200	4 Position Valve Stem O-ring
310-1039	G-3264	Tube to Spin-O-Cycle Gasket
327-1007	G-3281	Friction Washer
348-1033	G-4263	Slinger Washer
MY220-RP	O-1041	Pump Gasket

DURA PLASTICS

—	O-2100	Union Ball Valve O-ring
---	--------	-------------------------

DYNAPURE

D-T1	O-1120	Tank O-ring
------	--------	-------------

E-Z CHLOR

—	O-2124	Flow Meter O-ring
12690-09	O-2024	Flow Meter Gasket
12690-22	G-4437	Silicone Valve Seal Gasket
12690-26	G-4327	Saddle Fitting Gasket
12883-03	O-1120	DP Tank O-ring
168090	G-4610	Bottom Flowmeter Gasket
168092	O-2082	Top Flowmeter O-ring
824050	G-4600	3/8" Saddle Gasket
824090	G-5075	Bottom Flowmeter Gasket
824090	G-4610	Bottom Flowmeter Gasket
824092	O-2082	Top Flowmeter O-ring
918	O-2519	Flowmeter Viton O-ring

EASTSIDE (SEE PUREX)**EDGEWOOD**

—	G-4003	Inlet Heater Gasket
—	G-4004	Outlet Heater Gasket

ELECTROFEED

—	O-2239	25 A Fitting O-ring
---	--------	---------------------

EQUATOR (KAFKO)

19-0159-2	G-3037	Face Plate Gasket
19-0552-1	G-3416	Main Drain Face Ring Gasket

ESTER WILLIAMS

—	G-3189	Port Hole Gasket-Above Ground
---	--------	-------------------------------

FIBERSTARS

A9981	O-2112	Small O-ring
A9982	G-4622	Large O-ring/Gasket

OEM PART# CROSS REFERENCE

FITS	OEM#	SSC#	DESCRIPTION
FILTER FLOW			
—		G-3214	Body Gasket

FISCHER-PORTER			
101W701U01	O-2503		Chlorinator Viton O-ring
101W704U01	O-2520		Chlorinator Viton O-ring
101W705U01	O-2521		Chlorinator Viton O-ring
101W706U01	O-2506		Chlorinator Viton O-ring
101W707U01	O-2502		Chlorinator Viton O-ring
101W709U01	O-2512		Chlorinator Viton O-ring
101W710U01	O-2519		Chlorinator Viton O-ring
101W711U01	O-2124		Chlorinator O-ring
101W715U01	O-2515		Chlorinator Viton O-ring
101W716U01	O-2514		Chlorinator Viton O-ring
101W718U01	O-2607		Chlorinator Viton O-ring
101W721U07	O-2614		Chlorinator Viton O-ring
101W814U01	O-2003		Chlorinator O-ring
101W816U01	O-2103		Chlorinator O-ring
101W901U01	O-2609		Chlorinator Viton O-ring
101W902U01	O-2517		Chlorinator Viton O-ring
101W903U01	O-2612		Chlorinator Viton O-ring
101W904U01	O-2510		Chlorinator Viton O-ring
101W905U01	O-2615		Chlorinator Viton O-ring
101W910U01	O-2205		Chlorinator O-ring
101W918U01	O-2608		Chlorinator Viton O-ring
101W920U01	O-2610		Chlorinator Viton O-ring

FLINT & WALLING			
—		G-3133	Sprinkler Pump Gasket
—		G-3136	Pump Jet Gasket
126544		MS-201	Pump Seal
126545		MS-201	Pump Seal
131100		MS-800	Pump Seal
132377		MS-800	Pump Seal
AC-16		MS-800	Pump Seal

GENERAL MAJOR			
—		G-3218	Body Gasket

GOULD			
—		O-2101	Old Style Turbo Valve O-ring

GRID			
—		O-2195	O-ring for 3050, 3051, 3052
3008		O-2129	Diverter O-ring
3009		O-2175	Cover O-ring

GUARDEX			
25475HYD	O-2228		Brominator Lid O-ring
B-94	O-2228		Brominator Lid O-ring
P72999	G-4428		Rubber Washer

GULF			
34106201	MS-201		Pump Seal
341064702	MS-2131		Pump Seal
352501903	O-2266		Power Tech 2 Lid O-ring
352501904	O-2309		Power Tech 2 Knob O-ring
352506104	O-2618		Power Tech Diffuser Gasket
352506230	O-1209		Power Tech Pump Gasket
352506260	O-1226		Power Tech Cover Gasket
352507091	O-2041		Power Tech 2 Housing O-ring

H & F			
—		O-2218	Pump O-ring
—		G-3207	Pot to Volute Gasket
—		G-3256	Volute Gasket

FITS	OEM#	SSC#	DESCRIPTION
—		G-3249	Volute Gasket-Thin
—		MS-1000	Pump Seal

HARMSCO			
201		MS-201	Pump Seal
550		O-1207	11" Rim Gasket/O-ring BF-84, 126 Large
551		O-2188	Standpipe O-ring
552		O-2200	Holding Rod O-ring
635		G-4402	15 Hole Cover Gasket
636		G-4403	15 Hole Cover Gasket
639		G-4334	Cover Gasket
671		G-4404	27 Hole Cover Gasket
783		O-2165	2 1/2" O-ring
784		O-2189	2 1/8" O-ring
930		O-2002	Holding Rod O-ring For BF96/BF144 Cartridge Filter

HAYWARD			
—		O-1030	Goldmarc Model 181 & 241 Cover O-ring
—		O-2221	Center Rod O-ring
—		F-8101	GM Series Sand Filter O-ring Kit
—		F-8102	Pro Series Plus Sand Filter O-ring Kit
—		F-8103	Sand Filter (S-160T) O-ring Kit
—		F-8104	Sand Filter (S-200) O-ring Kit
—		F-8105	Sand Filter (S-240) O-ring Kit
—		F-8106	Sand Filter (S-245T, S-190T) O-ring Kit
—		F-8201	EC-65 & EC-75 Perflex DE Filter O-ring Kit
—		F-8202	Micro Clear S. St. DE Filter O-ring Kit
—		F-8203	EC-40 & EC-50 Perflex DE Filter O-ring Kit
—		F-8204	Micro Clear Dura., Perma., DE Filter O-ring Kit
—		F-8301	Super Star Clear Cartridge Filter O-ring Kit
—		F-8302	Star Clear II Cartridge Filter O-ring Kit
—		F-8303	Star Clear Cartridge Filter O-ring Kit
—		F-8304	Micro Star Clear Cartridge Filter O-ring Kit
—		F-8305	Super Star Clear C-3000S & C-4000S O-ring Kit
—		F-8306	Star Clear Plus Cartridge Filter O-ring Kit
—		R-6101	Max-Flo 1800-2800 Pump Repair Kit
—		R-6102	Super II Pump Repair Kit
—		R-6103	Super Pump Repair Kit
—		R-6104	Powerflo-Clear Cover-Pump Repair Kit
—		R-6105	Powerflo-Solid Cover-Pump Repair Kit
—		R-6106	SP-1250 Cast Iron Pump Repair Kit
—		R-6115	SP710X/711 '69-'75 5 Spoke Multiport Repair Kit
—		R-6116	SP710/711 '69-'75 6 Spoke Multiport Repair Kit
—		R-6117	Turboflo 2000-2100 & Powerflo 1500 Repair Kit
—		R-6118	Powerflo 1700 Pump Repair Kit
—		R-6148	SP-410X Slide Valve Repair Kit
—		O-2223	Cartridge Filter Center Rod O-ring
—		R-6158	CL200 Chlorinator Repair Kit
CLX0110-K		O-2504	Chlorine Feeder Viton O-ring
CLX0200-K		O-2511	Chlorinator Viton O-ring
CLX0200-LA		K-6003	Chlorinator O-ring Kit
CX0120-D		O-2095	Cartridge Filter Lid O-ring
CX0250-F		O-1215	250, 500 & 750 Tank O-ring
CX0250-Z-6		O-2223	O-ring
CX0250-Z-7		O-2116	Locking Knob Cartridge Filter O-ring
CX0400-G		O-2307	Cover O-ring
CX0800-F		O-1054	800 and 1100 Cartridge Filter O-ring
CX0900-F		O-2306	Filter Head O-ring
CX0900-H		O-2239	Star Clear Plus O-ring
CX2500-3-Z-2		G-4111	Gasket
CX2500-5-B-1		G-3017	Gasket
DEX0360-E		O-2186	Bulkhead Fitting O-ring
DEX0360-K		O-1099	Micro Clear DE Vertical S/S Filter Tank O-r

OEM PART# CROSS REFERENCE

FITS OEM#	SSC#	DESCRIPTION
DEX0360-M	O-2199	Bulkhead Fitting O-ring
DEX2400-K	O-1001	Micro Clear Vertical Fiberglass Tank O-ring
DEX2400-S-5	G-4212	Micro Clear Filter Relief Valve Tank Gasket
DEX2400-Z-3A	O-2253	Micro Clear DE O-ring
DEX2400-Z-5	O-2106	Outlet Elbow O-ring
DEX2420Z8A	K-6020	Swimclear Cartridge Filter O-ring Kit
ECX009611246	O-2135	EC Filter Pump Shaft O-ring
ECX1003	G-5153	DE Diaphragm Gasket for EC-30, 40, 50-With Holes
ECX1105	G-5152	DE Diaphragm Gasket for EC-65, 75- No Holes
ECX1287	O-2105	DE Filter Gauge O-ring
ECX1321-A	O-2090	Micro Star Air Relief Valve O-ring
ECX2899-A	O-2124	Perflex Pump Shaft O-ring, Small O-ring
GMX0142-C-8	O-2122	O-ring
GMX0142DA2	G-4460	Sand Filter Gasket
GMX0142-Z-2	O-2188	Pump O-ring
GMX0152-Z-5	O-2116	Drain Plug O-ring (After 1979)
GMX0400-D	G-3185	GM-400 Multiport Gasket
GMX0400-F	O-2164	Valve to Tank Lid O-ring
GMX0400-P	O-2248	Flange Mount Valve Stem O-ring
GMX0600-D	O-2144	Teflon Bearing Washer O-ring
GMX0600-F	O-2058	Filter Tank Lid O-ring
GMX0600-FST	O-1095	Threaded Filter/Valve Lid O-ring
GMX0600-P	O-2248	GM-600 Valve O-ring
RGX0045-G	O-1144	Regenex Filter Head O-ring
SFX0400-Z-1	O-2004	Large Drain Valve O-ring
SPSTX0305-F	G-4332	1 1/2" In Line Trap Cover Gasket
SPSTX0315-Z1	G-4273	2" In Line Trap Cover Gasket
SPSTX0325-F	G-4272	3" In Line Trap Cover Gasket
SPSTX0330-Z1	G-4269	4" In Line Trap Cover Gasket
SPSTX0335-Z1	G-4270	5" In Line Trap Cover Gasket
SPSTX0340-Z1	G-4218	6" In Line Trap Cover Gasket
SPSTX0345-H	G-4264	8" In Line Trap Cover Gasket
SPST0266Z5B	O-2025	Hair and Lint Strainer O-ring-320, 325, 320R, 325R
SPST0269Z5B	O-2022	Hair and Lint Strainer O-ring-304, 340R
SPX0045	LP-275	1/2" Loop Type Hook-Chrome Plated Brass
SPX0047	LP-276	3/4" Loop Type Hook-Chrome Plated Brass
SPX0058-D	G-3131	Main Drain Gasket
SPX0071-C-2	G-4328	Sight Glass Gasket (For Kit Order 2)
SPX0072-C-2	G-4261	Gasket
SPX0072-Z-4	O-2208	Sight Glass O-ring
SPX0084-M	G-3016	Skimmer Gasket
SPX0090-E	G-3018	Skimmer Gasket
SPX0097-E	G-3003	Skimmer Gasket
SPX0099-E	G-3019	Skimmer Gasket
SPX0102-Z-32	G-4214	Gasket
SPX0125-F	G-4227	Motor Shaft Slinger Gasket
SPX0125-G	G-3166	Pump Gasket
SPX0125-H	G-3219	Pump Gasket
SPX0125-T	G-5039	Pump Lid Ring
SPX0125-Z-2	MS-372	Pump Seal
SPX0125-Z-3	G-5003	Volute Pump Diffuser Ring
SPX0145-G	G-3168	Pump Gasket
SPX0145-T	G-5009	Pump Lid Gasket
SPX0409-C-2	G-3173	Fitting Gasket (For Kit Order 2)
SPX0410-Z-1	O-2008	SP410X Piston O-ring-Small
SPX0410-Z-2	O-2150	SP410X Large Piston O-ring
SPX0501-HJ	K-6002	Light Lens O-ring Set
SPX0505-G	G-3132	Shell Assembly Gasket
SPX0506-D	G-3165	Niche Gasket
SPX0508-B-A	G-3215	Cover Gasket Only
SPX0540-Z-2	G-5126	Light Lens Gasket
SPX0577-Z-1	G-4110	Deck Box Cover Gasket
SPX0602-F	G-4121	Gasket
SPX0602-Z-2	O-2141	Valve O-ring
SPX0603-F	G-4103	Cover Gasket
SPX0603-Z-2	O-2133	Stem O-ring
SPX0603-Z-2	G-5142	Valve Teflon Piece With Split

FITS OEM#	SSC#	DESCRIPTION
SPX0605-F	G-4112	Cover Gasket
SPX0605-Z-2	O-2261	Stem O-ring
SPX0605-Z-2	G-5142	Valve Teflon Piece With Split
SPX0605-Z-2V	O-2515	Drain Plug O-ring-Viton
SPX0704-F	O-2128	1 1/2" Vari-Flo Cover O-ring
SPX0710-D	G-5108	6 Spoke Spider Gasket (Prior to 1977)
SPX0710-R	G-4280	Multiport Valve Sight Glass Gasket
SPX0710-XD	G-5106	5 Spoke Spider Gasket (After 1977)
SPX0710X-Z-3	O-2128	Vari-Flow Lid O-ring (After 1976)
SPX0710-Z-1	G-3277	Non-Metallic Bearing Gasket
SPX0710-Z-14	G-3277	Non-Metallic Bearing Gasket
SPX0710-Z-16	G-3277	Non-Metallic Bearing Gasket
SPX0710-Z-3	O-2025	Valve Lid O-ring (Prior to 1976)
SPX0712	O-2160	Vari Flo Pipe Socket O-ring
SPX0715-Z-1	O-2067	Multiport Valve Cover O-ring
SPX0722-G	O-2155	Ball Valve End Connector O-ring
SPX0722-H	O-2124	Stem O-ring (Prior to 1975)
SPX0724-G	O-2117	End Connector O-ring
SPX0727-K	O-2243	Valve O-ring
SPX0728-H	O-2243	End Connector O-ring
SPX0733-Z-1	O-2242	Valve Key O-ring
SPX0735-G	O-2256	Valve Stem O-ring
SPX0735-GA	K-6001	Vari Flo Valve O-ring Kit
SPX0735-H	O-2280	Ball Valve Connector O-ring
SPX1019BA	GC-490	Replacement Grate With Screws For Socket Gutter/Deck Drain
SPX1022B	WP-21	Flush Plastic Winterizing Plug with O-ring
SPX1022-C	O-2115	Seal Plug O-ring
SPX1022S	RF-482	Gunite Pool I/O Fitting-1 1/2" Socket x 2" MIP
SPX1023	RF-481	Vinyl Pool I/O Fitting-1 1/2" FIP
SPX1023-Z-12	G-4290	Return Fitting Gasket
SPX1023-Z-3	G-3242	Inlet/Outlet Washer Gasket-Fiber
SPX1025-Z-1	G-4299	Return Fitting Gasket
SPX1025-Z-12	G-4259	SP-1025 Gasket (For Kit Order 2)
SPX1025-Z-3	G-3262	SP-1025 Filter Slip Washer
SPX1035-B	G-4243	SP-1035 AV Main Drain Gasket
SPX1035-C	G-3262	SP-1035 AV Main Drain Fiber Sealing Slip Gasket
SPX1039-C-2	G-3137	Fitting Gasket (For Kit Order 2)
SPX1048B	MF-457	Vinyl Pool Main Drain Sealing Frame Ring
SPX1048-D	G-3170	Main Drain Vinyl Gasket-Fiber
SPX1048-D	G-4116	Main Drain Vinyl Gasket-Rubber
SPX1058-D	G-3124	Main Drain Gasket
SPX1070-Z-1	O-2122	Float Valve O-ring
SPX1070-Z-2	O-2049	Float Valve O-ring
SPX1072-4-2	G-4306	Gasket
SPX1082E	SC-491	Square Skimmer Cover
SPX1082-Z410	O-2090	Star Clear Relief Valve O-ring
SPX1082-Z-5B	O-2252	Powerflo Volute O-ring (Before 1986)
SPX1084-B	G-3020	Skimmer Gasket
SPX1084-B-3	G-3014	SP-1084-OM Gasket
SPX1084F	SF-451C	1084 Skimmer Faceplate Cover
SPX1084-L	SF-451	Skimmer Faceplate to fit 1084 Skimmers
SPX1085B	SF-452	Widemouth Skimmer Faceplate
SPX1085-D	G-3001	Skimmer Gasket
SPX1085F	SF-452C	1085 Widemouth Skimmer Faceplate Cover
SPX1090-D	SF-450	Skimmer Faceplate for 1090 Skimmers
SPX1090-E	G-3006	Vinyl Skimmer Gasket-Fiber
SPX1090-E	G-4001	Vinyl Skimmer Gasket-Rubber
SPX1091-Z-7	HA-460	Hose Adapter-1 1/2" MIP X 1 1/4" & 1 1/2" Hose
SPX1094-G	G-3002	Skimmer Gasket-Fiber
SPX1094-G	G-4041	Skimmer Gasket-Rubber
SPX1097-E	G-3003	Skimmer Gasket
SPX1099-E	G-3026	SP-1099S Skimmer Gasket
SPX1250-G	G-3128	Pump & Mounting Bracket Gasket
SPX1250X-Z-2	MS-200	Pump Seal
SPX1408	RF-480	Vinyl Pool I/O Fitting-1 1/2" FIP x 1 1/2" FIP

OEM PART# CROSS REFERENCE

FITS OEM#	SSC#	DESCRIPTION
SPX1408-B	RF-455	Return Fitting Faceplate to Fit 1408 Fitting
SPX1408-C	G-4134	Vinyl Eyeball Gasket
SPX1411-Z-12	G-4124	Gasket for SP-1411, 1407-1
SPX1419A	DF-485A	Directional Flow Outlet Fitting-Slotted Sweep Opening
SPX1419B	DF-485B	Directional Flow Outlet Fitting-3/8" Directional Stream
SPX1419C	DF-485C	Directional Flow Outlet Fitting-1/2" Directional Stream
SPX1419D	DF-485D	Directional Flow Outlet Fitting-3/4" Directional Stream
SPX1419E	DF-485E	Directional Flow Outlet Fitting-1" Directional Stream
SPX1425-Z-6	O-2195	EC-65 Inlet Fitting O-ring
SPX1432-E	G-4260	Jet Air Mini Jet Gasket
SPX1434-J	O-2096	Vari Flo Nozzle O-ring
SPX1434-L	G-4249	Jet Air III Gasket
SPX1434-TP	O-2134	O-ring
SPX1438-H	O-2098	Pro Jet O-ring
SPX1438-J	G-4229	Pro Jet Gasket
SPX1441-Z-1	O-2141	Valve Stem O-ring
SPX1450-G	G-4636	Turbo Boost Spa Jet Jumbo Return Fitting Gasket
SPX1450-M	O-2023	Turbo Boost Winter/Test Plug O-ring
SPX1483-C	O-2231	Valve Union O-ring
SPX1485-B-6	O-2195	Union Elbow O-ring
SPX1485-C	G-5033	Sand Filter Elbow Ring
SPX1491-B	O-2020	Econo Union O-ring
SPX1495-Z-1	O-2040	Ball Valve Flush Union O-ring
SPX1500-H	G-3125	Pump Gasket-Fiber
SPX1500-H	G-4119	Pump Gasket-Rubber
SPX1500-KA	MS-2131	Pump Seal
SPX1500-M	O-2104	SF400 Small Drain Valve O-ring
SPX1500-N	O-2282	O-ring
SPX1500-P	O-2007	Power Flow Pump Lid O-ring
SPX1500-RA-1	G-4422	Pump Check Valve Gasket
SPX1500-W	O-2152	Strainer Connector O-ring
SPX1500-X	G-3268	Pump Gasket
SPX1580-Z-1	O-2209	Powerflo Housing O-ring
SPX1600-R	O-2618	Super Pump Diffuser Gasket
SPX1600-S	O-1226	Super Pump Lid Gasket
SPX1600-T	O-1209	Super Pump Gasket
SPX1600-Z-2	MS-201	Pump Seal
SPX1700-FG	G-4267	Washer
SPX1705-Z-1	O-2143	Pump Housing O-ring
SPX1905-E	O-2185	Self Drain Pump Housing O-ring
SPX3000-S	O-2247	SP3000 Pump Lid O-ring
SPX3000-SV	O-2518	Chlorinator Cover Viton O-ring
SPX3000-T	O-1217	Super II Pump Housing Gasket.O-ring
SPX3500-K	O-2618	Super Spa Pump Diffuser Gasket
SX0160-Z-1	O-1049	Sand Filter Tank O-ring
SX0180-G	G-4443	Sand Filter Gasket
SX0200-Z-14	O-2261	1980 O-ring
SX0200-Z-3	O-2270	Filter O-ring
SX0200-Z-4	O-2165	S-160 & S-240 Sand Filter O-ring
SX0200-Z-5	O-2133	Filter O-ring
SX0200-Z-6	O-2091	Sand Filter Lid O-ring
SX0200-Z-7	O-1159	S-200 Filter Tank O-ring
SX0200-Z-9	G-4325	Sand Filter Drain Gasket
SX0220-Z-2	O-2056	Bulkhead Fitting O-ring
SX0220-Z-3	O-2282	Pro Filter O-ring
SX0240-Z-1	O-1044	Sand Filter Tank O-ring
SX0360-Z-1	O-2355	O-ring

HERCULES SPA PACKS (DIV. OF JACUZZI)

1370097	G-4055	Skimmer Gasket
605100	MS-200	Pump Seal
755314	O-2346	O-ring
760502	O-2020	Heater Element O-ring

FITS OEM#	SSC#	DESCRIPTION
HOMELITE		
62363-A	G-4223	Gasket
62665-A	G-4234	Impeller Housing Gasket
62772	O-2079	O-ring
75911-A	MS-201	Pump Seal
HUSTLER		
A111	O-2141	Small O-ring
A211	O-2239	Large O-ring
HYDREL		
8092-S	G-5131	Lens Gasket
HYDRO (SEE ALSO PAC FAB)		
—	MS-201	Pump Seal
PO-0050	O-2079	Dynamic Pump Volute O-ring
HYDRO AIR		
—	O-2006	ADI Flowjet O-ring
—	O-2051	Air Control O-ring
10-027EP70	O-2321	Butterfly Jet O-ring
10-2204	G-4370	Air Control Valve Gasket
10-3705	G-4366	Air Control Valve Gasket
10-3804	G-4244	Wall Fitting Gasket
10-3953	O-2053	Jet Assemblies O-ring
10-5008	G-4380	Whirlpool & USR Jet Gasket
10-5834	O-2144	Mark II Jet Assembly O-ring
10-5847	G-4343	Mark II Jet Assembly Gasket
10-5857	O-2195	O-ring
10-6003	G-4377	Adjustable Skimmer Gasket
11-3429	O-2195	O-ring
11-3469	O-2226	O-ring
16-5004	G-4048	Hydr'ssage Cannister Gasket
16-5523	G-4142	Thera'ssage Gasket
16-5623	G-4047	Verta'ssage Backing Plate Gasket
HYDRO QUIP		
60-0001	O-2086	Heater Element O-ring
61-0001	G-4396	Heater Union Gasket
61-0011	G-4358	1 1/2" Heater Union Gasket
HYDROPUMP (SEE ALSO PAC FAB)		
—	O-2121	5" H & L Trap O-ring
—	O-2247	6" H & L Trap O-ring
—	G-3135	560-700 Series Gasket
—	G-3178	400 Pot to Volute Gasket
—	G-3127	650 Pump Gasket
—	G-3140	Pump Sweep Motor Gasket
400	G-3161	Pot to Volute Gasket
511	G-3207	Pot to Volute Gasket VB20
HL4	O-2086	4" H&L Trap O-ring
VB2	G-3160	Volute Gasket-200 Series VB2
VB20	G-3207	511 Pot to Volute Gasket
VB40	G-3159	Volute Gasket
HYDROTECH		
25475	G-5077	Lid Ring
25475HYD	O-2228	Brominator Lid O-ring
B154	G-4319	Brominator Air Vent Gasket
B94	O-2228	Brominator Lid O-ring

OEM PART# CROSS REFERENCE

FITS			FITS		
OEM#	SSC#	DESCRIPTION	OEM#	SSC#	DESCRIPTION
HYPRIME					
—	O-2020	Small Impeller O-ring	13-0013-00	G-3407	1 1/2" Plug Gasket
—	O-2040	Large Impeller O-ring	13-0014-09	G-4052	Gasket
—	O-2128	Lid O-ring	13-0015-08	G-4623	Return Flange Gasket
—	O-2165	Pot to Volute O-ring	13-0061-01	G-3216	Pump Gasket
—	O-2195	Impeller O-ring	13-0090-06	G-4434	Pump Flapper Gasket
INTERNATIONAL			13-0136-02	G-4433	Flange Gasket
—	O-2066	Manifold O-ring	13-0150-02	G-3216	VB-21 Gasket
—	O-2124	Crank O-ring	13-0178-01	G-4410	U Pump Gasket
—	O-2254	Collection Tube O-ring	13-0191-04	G-3176	Gasket
—	O-2255	Lower Piston O-ring	13-0192-03	G-3172	Gasket
—	G-3254	Bonnet Flange Gasket	13-0220-09	O-1010	Flange O-ring
6291-9	O-1121	Tank O-ring	13-0221-08	O-1125	Flange O-ring
6721-9	O-1122	Tank O-ring	13-0239-08	G-4427	5-Way Valve Gasket
JACUZZI			13-0243-02	G-3154	Gyromat Valve Gasket
—	O-2006	Collection O-ring	13-0244-01	G-4203	Filter Gasket
—	O-2080	U25B Lid O-ring	13-0273-05	G-3138	4 Way Valve Gasket
—	O-2115	4 Way Valve Upper O-ring	13-0275-03	G-4252	4-Way Valve Gasket
—	O-2259	Plastic Multiport Stem O-ring	13-0277-01	G-3217	4 Way Valve Gasket
—	F-8114	Laser Sand Filter O-ring Kit	13-0300-02	G-4230	Flange Gasket
—	F-8216	Landslide DE Filter, DE Sep. Tank O-ring Kit	13-0301-01	O-1055	Tank Clasp O-ring
—	F-8315	CFR Cartridge Filter O-ring Kit	13-0314-06	G-3202	Pump Gasket-Fiber
—	F-8314	CFR 25 Cartridge Filter O-ring Kit	13-0314-06	G-4186	Pump Gasket-Rubber
—	F-8322	Tri-Clops & Earthworks Cart. Filter O-ring Kit	13-0329-09	G-4125	Gasket
—	R-6119	Magnum Pump Repair Kit	13-0377-00	G-5027	Multiport Valve Gasket
—	R-6120	R and RC Series Pump Repair Kit	13-0378-09	G-5023	5-Way Valve Gasket
—	R-6147	LR Series Pump Repair Kit	13-0379-08	G-4450	PJM Flange Gasket
—	G-3182	Filter Gasket	13-0411-08	G-3012	Face Plate Gasket For Wide Mouth Skimmer
—	R-6160	PJM Pump Repair Kit	13-0414-05	G-4223	Cartridge Filter Tube Gasket
—	R-6162	ULSB & ULSC Pump Repair Kit	13-0417-02	O-1116	Cartridge Filter Cover O-ring
—	R-6166	SLPH, SLTPH, LCU, etc., Pump Repair Kit	13-0428-09	O-1123	SS-24 Filter Tank O-ring
—	R-6167	LPH, LPC, LTPH, LH & LTH Pump Repair Kit	13-0462-06	G-3026	SV, SL Skimmer Gasket
—	R-6165	PH & UPH Pump Repair Kit	13-0463-05	G-3171	SL Skimmer Suction Fitting Gasket
—	R-6168	P, PC, EP Series Pump Repair Kit	13-0864-00	G-4152	Main Drain Gasket
—	R-6164	8M & 10M Pump Repair Kit	13-0872-06	G-4258	Valve Gasket
—	R-6163	Cygnat Pump Repair Kit	13-0877-05	G-3198	Gasket
—	R-6161	J, JCM, K & KM Pump Repair Kit	13-0878-04	G-3021	Flange Gasket
—	F-8119	MFM 17, 20, 24 Sand Filter O-ring Kit	13-0880-00	G-4102	M/V Gasket
—	F-8120	RMST-24, ST27, ST33 Sand Filter O-ring Kit	13-0881-09	G-5041	Underdrain Gasket
—	F-8218	Earthworks DE Filter O-ring Kit	13-0888-02	G-3171	5-Way Valve Gasket
01-0990-00	G-4046	JWB Whirlpool Gasket	13-1020-09	G-4369	HT & WHJ Jet Gasket, Valve Gasket
01-3610-09	E-6505	Pump/Motor Shaft Extension	13-1021-08	G-4399	Fitting Gasket
10-0002-06	MS-200	Pump Seal	13-1022-07	G-4447	Laser Sand Gasket
10-0420-00	MS-201	Pump Seal	13-1023-06	G-4459	CFR Gasket
10-0476-00	MS-200	Pump Seal	13-1075-03	G-4618	2" Valve Gasket
10-0477-00	MS-201	Pump Seal	13-1207-04	G-4151	Main Drain Gasket
10-0478-00	MS-359	Pump Seal	13-1223-04	G-3153	Gasket
10-0479-00	MS-358	Pump Seal	16-0920-12	G-5035	XL-VII Pump Ring
10-0486-00	MS-201	Pump Seal	17-0228-68	O-2165	Union O-ring
10-0487-00	MS-201	Pump Seal	20-1010-00	O-2024	RTC Pump O-ring
10-0506-00	MS-359	Pump Seal	42-2927-06	O-1101	Dial Valve & Sandtrap Filter Adapter Valve O-ring
10-0563-00	MS-162	Pump Seal	47-0008-07	O-2222	CFR Air Vent O-ring (Prior 1/88)
10-1202-00	MS-359	Pump Seal	47-0013-00	O-2248	Drain Plug O-ring
10-1203-01	MS-877	Pump Seal	47-0016-05	O-2220	1 1/2" Valve O-ring
10-1203-19	MS-877	Pump Seal	47-0016-06	O-2220	Filtromat Cover O-ring
10-1390-04	MS-201	Pump Seal	47-0020-01	O-2257	K Series Filtromat O-ring
10-1436-00	MS-200	Pump Seal	47-0021-00	O-2288	Air Control Valve Seat O-ring
10-1502-09	MS-201	Pump Seal	47-0022-09	O-2205	Shaft Sleeve O-ring
13-0006-09	G-4141	Vinyl Return Fitting Gasket	47-0028-03	O-2254	Filter Valve O-ring
13-0007-08	G-3038	Standard Throat Gasket	47-0080-76	O-2222	O-ring
13-0010-03	G-3001	Skimmer Gasket	47-0106-08	O-2153	CFR Vent O-ring
13-0011-02	G-3406	2" Plug Gasket	47-0110-02	O-2090	Valve & Filter O-ring
			47-0112-00	O-2024	Stem & Crank O-ring
			47-0112-99	O-2024	Plug O-ring
			47-0115-07	O-2102	S/W Injector O-ring
			47-0116-05	O-2220	Valve O-ring
			47-0116-30	O-2220	Dial Valve O-ring
			47-0117-05	O-2220	Shaft O-ring
			47-0118-04	O-2242	S/W Injectors O-ring

OEM PART# CROSS REFERENCE

FITS OEM#	SSC#	DESCRIPTION	FITS OEM#	SSC#	DESCRIPTION
47-0123-07	O-2264	RM2 Injector Cap O-ring (As of 11/91)	47-0434-01	O-2080	Magnum Pump Lid O-ring Prior to 7/89
47-0126-04	O-2131	DB3 Sleeve O-ring	47-0438-07	O-2247	Cast Iron Pump Lid O-ring
47-0129-01	O-2020	Skimmer Mat O-ring	47-0439-06	O-2054	Cast Iron PJM Lid O-ring
47-0131-07	O-2009	Gyro Flo O-ring	47-0442-01	O-2094	H&L Strainer O-ring
47-0139-09	O-2106	TP4 Test Plug O-ring	47-0443-00	O-2293	Sandtrap Filter V/A O-ring
47-0142-04	O-2199	2" Valve O-ring	47-0448-05	O-1010	O-ring
47-0143-03	O-2049	2" Multiport Valve O-ring (After 8/73)	47-0462-06	G-5046	Square Diffuser Gasket
47-0144-02	O-2234	2" Multiport Valve O-ring (Prior to 8/73)	47-0463-05	G-5035	F Series Pump Square Seal Ring
47-0161-00	O-2212	DA1A-DA1B Case O-ring	O-2094	O-2094	2" DV Cover O-ring
47-0165-06	O-2295	D83 Case O-ring For DB1 Pump	47-0465-03	O-2256	Diverter Dial Valve O-ring
47-0175-04	O-2373	SC Series Case O-ring	47-0466-02	G-5016	Strainer and Case Gasket
47-0212-09	O-2256	RM2, 3 S/W Injector O-ring	47-0467-01	O-2226	Dial Valve O-ring
47-0212-66	O-2264	O-ring	47-0569-99	O-1015	Earth Works Tank O-ring
47-0213-08	O-2221	S/W Injection Plug O-ring	47-6172-04	O-2374	Top O-ring for Sandstorm 31 Filter
47-0214-07	O-2264	Valve Stem O-ring	94-1104-67	G-3022	SV Basic Skimmer Face Gasket
47-0214-49	O-1073	Earth Works Filter O-ring	JANDY (DIVISION OF LAARS)		
47-0216-05	O-2255	Verturi O-ring	—	O-2124	Leaf Trap O-ring
47-0218-11	O-2203	Air Control O-ring	1132	O-2175	Vinyl Cover O-ring
47-0218-45	O-2203	Air Control O-ring	1307	O-2220	Shaft O-ring
47-0220-09	O-2142	Test Plug O-ring-TP1	2300	O-2003	Porpoise Hydrotimer Case O-ring
47-0221-08	O-2020	4 Way Valve Disc Body O-ring	2614	O-2125	Energy Filter Bowl O-ring
47-0222-07	O-2020	PM Filter Valve O-ring	2644	G-4063	Valve Actuator Gasket
47-0222-07	G-4265	PM Filter Valve Gasket	3293	O-2125	Sheer Descent Cover O-ring
47-0223-06	O-2231	Filter Valve O-ring	3381	O-2155	Space Saver Valve O-ring
47-0224-05	O-2115	PM Filter Valve O-ring	4487	G-4401	Vac Floor Gasket
47-0226-03	O-2195	Inlet Fitting Seal O-ring	6749	O-2049	Valve O-ring
47-0227-02	O-2040	Gyro-Flo O-ring	R0338200	MS-601	Pump Seal
47-0227-36	O-2040	Gyromat B/W Lower Valve O-ring	R0338700	O-2146	High Head Pump Body O-ring
47-0228-01	O-2165	Jet Charger 225 A, B, C O-ring	R0338801	O-2100	Diffuser O-ring
47-0228-35	O-2165	Gyromat B/W Upper Valve O-ring	R0338900	O-2224	Pot Lid O-ring
47-0228-68	O-2165	Union O-ring	R0339600	O-2002	Coupling Set O-ring (For Kit Order 2)
47-0229-00	O-2226	O-ring	R0340400	O-2214	Medium Head Body O-ring
47-0232-54	G-5031	Magnum Diffuser Square Ring	R0350600	O-1160	C Series Cartridge Filter Tank O-ring
47-0233-04	O-2015	H4 Booster O-ring	R0353400	O-2390	CT Series Cartridge Filter Lid O-ring
47-0248-56	G-5026	Dial Valve Square Ring	R0354400	G-4634	SF-S Sand Filter Half Union Gasket
47-0251-01	O-2252	Press Molder Lint Catcher O-ring	R0357800	O-1161	CL Series Cartridge Filter Tank O-ring
47-0255-07	O-2346	DVK-7 O-ring	JOHNS MANVILLE		
47-0256-06	O-2041	PM Filter Valve O-ring	—	O-2125	Johns Manville & Amitek O-ring
47-0257-05	O-2143	Separation Tank Support O-ring	K-D POOLS		
47-0258-04	O-2209	O-ring	10-0002-06	MS-200	Pump Seal
47-0258-53	G-5060	L Series (After 5/88), CFT & RPZ Square Ring	13-0378-09	G-5023	Sand Filter Square Ring Gasket
47-0258-61	G-5035	L Series Pump Square Ring	13-1023-06	G-4459	Cartridge Filter Gasket
47-0262-08	O-2089	O-ring	47-0106-08	O-2153	Cartridge Filter O-ring
47-0264-06	O-2146	5-Watt Valve O-ring	47-0112-00	O-2024	Sand Filter O-ring
47-0268-02	O-2034	PM Filter Top O-ring	47-0258-53	G-5060	LR6 Gasket
47-0326-02	O-2134	Sand Trap Plug O-ring	47-0352-41	O-2059	LR6 Strainer Cover O-ring
47-0331-05	O-2009	O-ring	47-0357-46	O-2266	K Square Ring
47-0347-07	O-2240	Gyromat O-ring	47-0380-47	O-2181	Cartridge Filter O-ring
47-0348-06	O-2272	Multiuse Pump & Filter O-ring	KAFKO (SEE EQUATOR)		
47-0349-06	O-2086	PJM Cap O-ring	KDI PARAPORT (SEE ALADDIN)		
47-0352-41	O-2059	Lid O-ring	KIM		
47-0353-08	O-2139	O-ring	—	O-2100	Rear Seal O-ring
47-0353-40	O-2139	Strainer Cover O-ring	—	O-2018	Lens O-ring
47-0354-07	O-2007	U Series Pump O-ring	KING (KINGFEEDER / KINGTECH)		
47-0355-06	O-2236	1 1/2" Sandtrap Filter Lid O-ring	—	O-2116	Kingfeeder Cam O-ring
47-0355-48	O-2236	PH Series Cover O-ring	01-22-1920	O-2523	New Water Cap O-ring, B-192 Ser. 100/200
47-0357-04	O-2266	Pump Lid O-ring			Cap O-rng
47-0357-46	O-2266	JC Pump Housing O-ring	01-22-1926	O-2088	Cap O-ring
47-0358-03	O-2224	Magnum Pump O-ring (After 7/89)	01-22-7850	G-4038	King Tech Scoop Gasket
47-0359-02	O-2224	PM Filter Valve O-ring	01227856	G-4038	Scoop Gasket
47-0360-09	O-2095	CFT 25 Filter O-ring			
47-0361-08	O-2300	RP3 Case O-ring			
47-0361-48	O-2300	Cygnat O-ring			
47-0364-05	O-2058	Dial Valve O-ring			
47-0364-47	O-2058	Magnum Pump Housing O-ring			
47-0370-07	O-2278	2" Multiport Valve O-ring			
47-0380-47	O-2181	CFT Cover O-ring			
47-0433-02	O-2172	Filtromat O-ring			
47-0433-51	O-2266	USLB 6" Lid O-ring			

OEM PART# CROSS REFERENCE

FITS OEM#	SSC#	DESCRIPTION
01-22-7856	G-4038	Scoop Gasket
01-22-9426	O-2214	Body O-ring ('91 & Prior)
01-22-9926	O-2224	Cap O-ring (Current)
106-000-016	O-2049	King Tech New Style Cap O-ring
106-100-007	O-2137	King Tech Old Style Cap O-ring
106-100-008	O-2155	Cam O-ring
106-100-019	O-2243	Basket O-ring
119	O-2137	Old Style Cap O-ring
122	O-2049	King Feeder Cap O-ring
192	O-2523	New Water Cap Viton O-ring
722	O-2243	Basket O-ring
746	O-2155	Cam O-ring
942	O-2209	King Tech Body Cap O-ring-Perform.
943	O-2516	King Feeder Performax Drain Plug Viton O-ring
945	O-2006	King Feeder Control Dial O-ring Kit
992	O-2224	400/430, 940 Cap O-ring
KREEPY KRAULEY (DIV. OF PENTAIR)		
12-800	O-2231	Swivel Housing O-ring
12866	G-4401	Universal Pool Cleaner Floor Gasket
LAARS (TELEDYNE LAARS)		
—	O-2102	Control Well O-ring
—	G-3235	Round By-Pass Gasket
—	G-4016	2 Button Command Center Face Plate Gasket
—	G-4210	Aqua Dyne Round Gasket
—	G-4315	Large Tube Round Gasket
—	G-4326	Small Tube Round Gasket
—	G-5048	Tube Late Style Gasket
—	G-4316	Washer
225	G-4303	3/16" Thick Washer
E-1164	G-5066	Gasket/O-ring
E-244	G-4442	Heater Gasket
E-325	G-3245	Heater Gasket
E-327	G-3274	Heater Gasket
E-363	O-2223	Heater O-ring
E-376	G-3025	Heater Gasket
E-516	G-3252	Thermostat Cover Gasket
F-111	G-3280	Heater Gasket
R00114	G-4612	By-Pass Valve, Flow Control Gasket
R0011400	G-5057	H1-E2 Heater By-Pass Valve Gasket
R0338805	O-2117	Diffuser O-ring-3 HP
R-508	G-5063	Header Gasket
S00531	G-5151	Heater Flange Gasket
S-055	G-4027	Heater Gasket
S-056	G-4315	Large Tube Round Gasket
S-056P	G-4316	Aqua Dyne Heater Washer
S-057	G-4326	Tube Round Gasket
S-057P	G-4303	Aqua Dyne 3/16" Thick Washer
S-151	G-4262	Heater Gasket
S-152	G-5048	Aqua Dyne Late Style Tube Gasket
S-154	G-5057	Flange Gasket
S-156	G-4304	Heater Gasket
S-157	G-4211	Heater Gasket
S-159	G-4286	Heater Gasket
S-245	G-4017	Heater Gasket
S-246	G-4024	Heater Gasket
S-248	G-4020	Heater Gasket
S-328	O-2208	Heater O-ring
S-606	G-5005	Heater Tube Gasket
S-690	O-2008	Heater O-ring
S-700	G-4037	Temp Control Gasket
S-702	G-5004	Heater Washer
S-708	G-5005	Heater Washer
S-735	O-2283	O-ring
S-737	G-4340	Tank Cover Gasket

FITS OEM#	SSC#	DESCRIPTION
S-741	G-5057	Flow Control Gasket (For Kit Order 3)
S-987	G-5149	Jacket Hole Plug
LONDON		
—	O-1127	Stainless Steel Tank O-ring
—	O-2008	Spin 1 1/2" Collection O-ring
—	O-2218	Pump Lid O-ring
—	O-2115	Backwash O-ring
—	O-1063	Separation Tank O-ring
—	O-2082	Crank Shaft O-ring
—	O-2002	2" Spin Collection O-ring
LASCO		
—	O-2155	2" PVC Union O-ring
—	O-2189	1 1/2" PVC Union O-ring
LEN GORDON		
—	G-4016	Face Plate Gasket
LESLIE'S		
SPX0710-Z-3	O-2025	Hydramax A/G O-ring
SPX1500-KA	MS-2131	Hydramax A/G Seal
SPX1500-W	O-2152	Hydramax A/G Strainer O-ring
SPX1600-R	O-2618	Hydramax II Diffuser Gasket
SPX1600-Z-2	MS-201	Hydramax II Seal
SPX1705-Z-1	O-2143	Hydramax A/G Housing O-ring
SPX3000-S	O-2247	Hydramax II Cover O-ring
SPX3000-T	O-1217	Hydramax II Housing Gasket
LETRO		
F-31	O-2003	Hose Assembly O-ring
JV-11	O-2369	Jet Vac O-ring
JV-18	O-2124	Jet Vac O-ring
JV-29	G-4391	Jet Vac Gasket
LA-08	MS-200	Pump Seal
LA1000	MS-1000	Pump Seal
LA-375	O-2253	Booster Pump Drain Plug O-ring
LA-40	G-5119	End Bell Gasket
LA-415	O-2089	Booster Pump O-ring
LD-10	G-5043	Hose Washer
LE-43	O-2220	Turbo Sweep O-ring
LF-07	O-2082	O-ring
LF-24	O-2135	O-ring
LG-12	O-2208	O-ring
LG-32	O-2263	O-ring
LJ-04	O-2144	O-ring
LL-13	O-2365	Housing Body O-ring
LL-14	O-2024	Gear Assembly O-ring
LLC140	O-2124	Thrust Jet O-ring
LLU7	O-2242	Feed Mast O-ring
P-40	O-2024	Hose Assembly O-ring
LIFEGUARD (SEE RAINBOW)		
LITTLE GIANT		
101601	G-4435	Impeller Housing Gasket
102601	G-4454	Volute Gasket-No. 2
103601	G-4457	Volute Gasket
928007	G-5067	Square Cut Ring
928024	G-5071	Gasket
928028	G-5065	Terminal House Gasket
LOCHINVAR		
GKT-2400	G-4056	Heat Shield Gasket

OEM PART# CROSS REFERENCE

FITS OEM#	SSC#	DESCRIPTION
LOMART (SEE DOUGHBOY FOR MORE LISTINGS)		
—	O-1063	Separation Tank O-ring
—	O-2002	Spin 2" Coll. O-ring
—	O-2082	Crankshaft O-ring
—	O-2115	Backwash Valve O-ring
—	O-2218	Pump Lid O-ring
—	K-6005	Backwash Plunger Pipe O-ring Kit
—	MS-150	Pump Seal
040-024	G-3209	Body Gasket
040-027	MS-142	Pump Seal
040-027	MS-163	Pump Seal
040-028	MS-142	Pump Seal
040-029	MS-163	Pump Seal
042-024	G-3180	Body Gasket
043-013	G-3143	Body Gasket
046-029	G-4263	Gasket
047-015	MS-1000	Pump Seal
047-016	MS-1000	Pump Seal
053-014	O-1051	13" Tank O-ring
053-015	O-1052	14" Tank O-ring
053-019	O-2135	Shaft O-ring
053-026	O-2020	Strainer O-ring
053-029	G-4309	Valve to Tank Gasket
053-044	O-2038	Back Wash Cap O-r, Pro Pump Diff. O-ring
053-047	G-3264	Gasket
053-049	O-2135	Valve Cover Plunger O-ring
053-050	O-2134	Backwash Valve O-ring
053-058	O-2121	Strainer Cover O-ring
053-074	O-1058	16" Tank O-ring
053-075	O-2051	Tube O-ring
053-097	O-1066	14" Tank O-ring
053-101	O-2127	O-ring
053-110	O-1064	11" Tank O-ring
053-120	G-4276	Viewport Lid Gasket
053-131	O-1119	Tank O-ring
053-132	O-2209	Cyclops Mark 5 O-ring
053-133	G-4219	Gasket
053-140	G-4241	Viewport Gasket
053-146	O-1124	24" Tank O-ring
053-157	G-4201	Gasket
053-159	O-2007	Strainer O-ring
053-174	O-1090	Tank O-ring
053-180	O-2146	Pro Pump O-ring
053-185	O-2150	O-ring
053-200	O-2095	Pro Pump Cover O-ring
053-210	O-1129	O-ring
053-211	G-4324	Gasket
053-213	O-1065	Tank O-ring
053-215	G-5028	Ring
1121-1057	MS-200	Pump Seal
304	MS-1000	Pump Seal
307-1023	G-4373	DIX Skimmer Return Gasket
308-1068	G-4043	S-12, 60-4012 Skimmer Gasket
308-1078	O-2089	Spectra II, Ultima II Valve to Tank O-ring
308-1089	G-4042	DIX Skimmer Gasket
308-1115	O-1013	O-ring
LUITWEILER		
—	O-2119	Pump Lid O-ring
—	O-2218	Pump O-ring
—	G-3101	Old Style Pump Gasket
—	G-3102	Large 4 Hole Gasket
—	G-3108	Pump Volute Gasket
—	G-3120	New Style Pump Gasket
—	G-3152	Small 4 Hole Gasket
—	MS-201	Pump Seal

FITS OEM#	SSC#	DESCRIPTION
MAGIC VALVE		
0301-226	O-2189	1 1/2" Union O-ring
0301-227	O-2270	2" Union O-ring
MARINE		
—	O-2024	Valve Stem O-ring
—	O-2115	Valve Cap O-ring
—	O-2121	5" Clear Plastic H&L Lid O-ring
—	O-2134	Valve Piston O-ring
—	O-2142	Valve Piston O-ring
—	O-2228	5" Clear Lid O-ring
—	O-2261	Old Style Crank O-ring
—	G-4298	DE Spin Filter Shaft Sleeve Gasket
1150	O-2264	Locknut O-ring
1160	G-4418	Bushing Cup Gasket
1220	G-4322	Flat Rubber Bushing Gasket
1340	O-2417	990MS & BH Filter Quad Ring
1350	O-2402	990MS & BH Filter Quad Ring
15151	MS-358	Pump Seal
1560	O-2189	Deck Filter Manifold O-ring
1560	G-5129	V Cup O-ring-Square Cut
1600	O-1080	Tank O-ring
166-6	O-2222	Thermometer O-ring
3660	G-4238	Flat Rubber Gasket
3760	O-1077	Tank O-ring
5260	O-1039	Tank O-ring
5280	O-2068	Bearing & Manifold O-ring
5740	O-1090	MS Tank O-ring
624-5	O-1131	Sand Filter Tank O-ring
7650-3	O-1069	6 3/4" Clear Pump Lid O-ring
7700	MS-1000	Pump Seal
9524	MS-703	Pump Seal
99-8088-5	G-5055	Small Separation Tank Ring
99-8660-5	G-5024	Large Separation Tank Gasket
MARLOW		
—	O-2020	Diffuser 1/3-1 HP Mardur Pump O-ring
—	O-2100	H Series 2 HP Diffuser O-ring
—	O-2112	Diffuser O-ring
—	O-2155	Mardur Pump Diffuser O-ring
—	G-3024	34 EC-15D Tank Cover Gasket
—	G-3106	34EC-15D Tank Gasket
—	G-3174	34EC-15D Pump Inlet Gasket
—	G-4277	AF Pump Cover Gasket (All Models)
—	G-5040	1-2 HP AF Pump Diffuser Gasket
—	G-3105	2112 8-Hole Large Cover Gasket
—	G-3266	VP-153 Strainer Body Gasket
15621	G-5073	AF Diffuser Gasket-1-2 HP
186862	BP-386	Pump Seal for L Stockline
21034	G-3103	Tank to Lantern Gasket
21035	O-2100	AF Diffuser O-ring-3 HP
2112	G-3105	Large 8 Hole Cover Gasket
22991	G-3111	Motor to Lantern Shim Gasket
23112	G-3166	H Series Pump Housing Gasket
23736	MS-411	Pump Seal
25353	MS-411	Pump Seal
25475	O-2100	H Diffuser O-ring-2 HP
25476	G-5017	3/4 & 1 1/2 HP H Series Pump Diffuser Gasket
25784	G-5007	Pump Cover Gasket
26144	G-5069	H Diffuser Gasket-3/4 to 1 1/2 HP
26467	MS-411	Pump Seal
26469	MS-406	Pump Seal
26588	G-3224	Discharge Gasket
26661	MS-406	Pump Seal
27223	MS-416A	Pump Seal
28484	G-4231	AF Series Pump Slinger Gasket-All Models
28983	G-5074	H Diffuser Gasket-1/3 & 1/2 HP

OEM PART# CROSS REFERENCE

FITS OEM#	SSC#	DESCRIPTION
29038	G-5019	Pump Gasket
30156	O-2140	1/2 & 1/3 HP Series Pump Diffuser O-ring
32540	G-5078	AF Strainer Cover Gasket
37478	G-5014	Mardur 1/3 to 1 HP Pump Cover Gasket
37479	G-5010	Mardur Strainer to Tank Gasket (All Models)
37482	G-5052	Mardur Pump Seal Plate Gasket
38592	MS-201	Pump Seal
39404	G-5016	1 1/2 & 2 HP Mardur Pump Seal Gasket
40478	O-2189	Gemini O-ring
42925	O-2118	Gemini O-ring
43117	O-2040	Argonaut Diffuser O-ring
44308	O-2167	Argonaut Cover O-ring
44802	O-2094	Argonaut Bracket O-ring
470400	G-3415	4 SPC Gasket
471210	G-3414	4 SPC Gasket
P48690	G-3404	L Stockline Pump Volute Gasket
VP-153	G-3266	Strainer Body Gasket

MARTEC (SONFARREL)

201-002	O-2220	Bleed Plug O-ring
201-004	O-2041	Filter Body O-ring
201-010	O-2024	Drain Plug O-ring
202-003	G-4382	Suction Filter Flange Gasket
205-104	O-2024	Bleeder O-ring
205-106	O-2294	Filter Head O-ring
300-004	O-2025	Wet End O-ring
300-009	MS-1000	Pump Seal
310-104	O-2252	Booster Pump O-ring
310-108	MS-1000	Pump Seal
320-102	O-2167	Trap Lid O-ring
320-108	G-4033	Flange Gasket
320-110	O-1082	Pool Master Housing O-ring
320-119	MS-201	Pump Seal
400-102	G-4352	DS Filter, JM Jet Gasket
400-108	O-2242	Reed Valve O-ring
410-504	O-2053	O-ring
410-506	G-4353	Bath Jet Gasket
410-511	O-2195	Bathmaster Jet Body O-ring
420-509	G-4341	BJ 5000 Gasket
420-512	G-3181	Eyeball Teflon Piece
610-112	G-4036	FAS Skim Filter Gasket
700-103	O-2195	Union O-ring
700-203	O-2226	Sonfarrel 2" Union O-ring
700-308	O-2226	2" Tailpiece O-ring
700-408	O-2115	1 1/2" O-ring for Tail

MASTER

08490-0031	G-4635	Master Turbo Clean Head Square Ring Seal
------------	--------	--

MEC-O-MATIC

88004-73	K-6004	HJ & Barracuda O-ring Kit
----------	--------	---------------------------

MIAMI TANK

—	O-1008	20" CF-104 Tank O-ring
—	O-1126	FG18 & FG24 Lid O-ring
CF-52	O-1055	16" Tank O-ring

MISCELLANEOUS GASKETS

—	G-4128	Light Deck Box Gasket
—	G-4228	2" Fire Hose Gasket
—	G-4237	3" Discharge Hose Flat Washer
—	G-4237	3" Fire Hose Gasket
—	G-4240	Fire Hose Coupling Gasket
—	G-4449	2" Discharge Hose Flat Washer
—	G-4461	Oval Rope Eye Gasket

FITS OEM#	SSC#	DESCRIPTION
----------------------	-------------	--------------------

MONARCH

—	O-2040	Old Time Impeller O-ring
—	O-2231	New Style Impeller O-ring
—	O-2270	Pump to Volute O-ring
—	G-3104	Pump Gasket
197989	O-1128	D7 O-ring
199696	G-4222	Seal Gasket

MUSKIN

—	O-2133	4 Way Valve Shaft O-ring
—	O-2414	4 Way Valve Seat Quad Ring
—	MS-150	Pump Seal
009-2001	MS-163	Pump Seal
037-3408	G-3273	Drain Cap Gasket
037-3410	O-1039	18" Tank O-ring
037-3412	O-2605	Blue Teflon Coated Strainer Pump Lid O-ring
037-3414	O-2134	Valve O-ring
037-3417	G-5053	Body Ring
037-3430	O-1106	20" Tank O-ring
037-3434	O-1041	16" Tank O-ring
037-5002	G-4281	Air Relief Valve Assembly Gasket
037-5071	G-4226	Grid Post Gasket
038-3410	G-4415	Drain Cap Washer
038-3416	G-4323	Tank Tube Valve Gasket
038-3421	G-4331	Spin Filter Gasket
038-3424	G-4288	Tank Gasket
038-3432	G-3225	Viewport Gasket
038-3439	G-3232	Jet Stream Tank Gasket
038-3446	G-4439	Adapter Gasket
038-3457	G-4328	Valve Body Gasket-Flat
038-3457	G-4424	1 1/2" Backwash Cap Gasket-Solid
038-3458	G-4014	Skimmer Gasket
038-5434	O-2134	O-ring
098-7235	G-3006	Skimmer Gasket-Fiber
098-7235	G-4001	Skimmer Gasket-Rubber
101-6910	G-3231	Vinyl Washer
275-0007	O-2346	6 Position Valve Cover O-ring
54003	G-4418	Valve Waste Cap Gasket
54004	G-4385	3/4" Washer
54005	G-3193	FP Pump, Drain Fitting Gasket
54006	G-3194	Air Relief Bushing Gasket
54007	G-3235	Tank to Valve Inside Washer
54008	G-5001	Clamp Nut Gasket
54009	G-3230	Viewpoint Gasket
54010	G-4294	Viewpoint Gasket
54011	G-3150	Self Priming Pump Housing Gasket
54012	G-3122	5 Position Valve Gasket
54013	G-4384	Vac Attach Skimmer Gasket
54014	G-3145	Discharge Fitting Gasket
54015	G-3022	Skimmer Face Plate Gasket
54016	G-3192	Backwash Valve Outside Tank Gasket
54017	G-3269	Valve Cover Gasket
54018	G-3004	A-4372 & A-4372F Skimmer Gasket
54019	G-5062	Cartridge Housing Gasket
54020	G-3191	Backwash Valve Cap & Pos. Valve Gasket
54021	G-3195	Mylar Resin Tank Gasket
54022	G-3196	Resin Tank Gasket
54023	G-3190	Thru Wall Return Gasket
54024	G-3035	Mini Skimmer Gasket
54027	G-4218	8" HMLI Tank Gasket
54028	G-4061	Skim Filter Body Gasket
54029	G-4613	Discharge Fitting Intake Gasket
54040	O-2420	5 Position Valve Quad Ring
54048	MS-163C	Seal Ceramic
54055	G-3403	Tank Gasket
54061	O-1034	Tank Gasket
54062	O-2133	Axle & Valve Shaft O-ring
54063	O-2104	Spider O-ring

OEM PART# CROSS REFERENCE

FITS			FITS		
OEM#	SSC#	DESCRIPTION	OEM#	SSC#	DESCRIPTION
54064	O-2086	Strainer Pump Lid O-ring	—	G-3135	Hydro 560-700 Series Gasket
54065	O-2146	9" Plastic Tank O-ring	—	G-3140	Hydro Pump Sweep Motor Gasket
54066	O-1102	15" Tank Lid O-ring	—	G-3178	Hydro 400 Model Pot to Volute Gasket
54067	O-2256	FP Parker Pump O-ring	—	G-3263	Washer
54068	O-1147	11" Tank O-ring	—	F-8108	Fiberglass Sand Filter O-ring Kit
54069	O-1148	18" Resin Tank O-ring	—	F-8110	PF 35/30 S. St. Sand Filter O-ring Kit
54072	O-2020	Filter O-ring	—	F-8111	PF 100 S. St. Sand Filter O-ring Kit
54076	G-3405	Poly Element Filter Gasket	—	F-8112	Tagelus Fiberglass Sand Filter O-ring Kit
54079	O-2128	Large Filter O-ring	—	F-8211	Star DE Filter O-ring Kit
72008	MS-142	Pump Seal	—	F-8212	400 Series DE Filter O-ring Kit
72031	O-1146	15" Metal Tank O-ring	—	F-8214	2000 Series Sand Filter O-ring Kit
72032	O-1149	14" Metal Tank O-ring	—	F-8308	50, 80, 100 S/F Mytilus & Mitra Cart. O-ring Kit
72033	O-2146	9" Plastic Tank O-ring	—	F-8309	60 S/F Mitra Cartridge Filter O-ring Kit
72034	K-6012	Cartridge Housing Gasket/O-ring Kit	—	F-8310	Mytilus 80, 100, 150S/F Cart. Filter O-ring Kit
72035	K-6014	3 Position Valve Gasket Kit	—	F-8311	Mytilus B Reinforced Cart. Filter O-ring Kit
72036	K-6015	5 Position Valve Gasket Kit	—	F-8312	Mitra S.S Cartridge Filter O-ring Kit
72037	K-6019	Fill Port Gasket Kit	—	R-6107	2" Slide Valve Repair Kit
72038	K-6017	Standard Skimmer Gasket Kit	—	R-6108	Challenger Pump Repair Kit
72039	K-6016	DLX Skimmer Gasket Kit	—	R-6121	Dynamo, Dynamite, Dynatron Pump Repair Kit
72040	K-6018	Resin 5 Position Gasket/O-ring Kit	—	R-6137	Universal Slide Valve Repair Kit
A-4372	G-3004	Skimmer Gasket	—	R-6138	Hydro Pump Repair Kit
A-4372F	G-3004	Skimmer Gasket	—	R-6139	Pinnacle Pump Repair Kit
MYERS			—	O-2024	Crankshaft O-ring
11416-A	MS-101	Pump Seal	—	O-2220	Crankshaft O-ring
NATURE 2			—	O-2028	5" H & L Trap O-ring
2-13035	O-2381	Model G Purifier Inlet O-ring	—	O-2282	Nautilus Lower Pipe Assembly O-ring
2-13061	O-2091	Cap O-ring	—	F-8217	Nautilus S/S DE Filter O-ring Kit
2-13073	O-2249	Cap O-ring	02-112	O-2024	Crankshaft O-ring
OLYMPIAN			02-116	O-2220	Crankshaft O-ring
—	F-8107	Sand Filter O-ring Kit	07-0951	G-4398	Tube Seal Gasket
OLYMPIC (AQUALEADER)			07-1725	MS-360	Pump Seal
ACM-83	G-3006K	Gasket Set	07-4015	G-4455	Flow Valve Gasket
ACM-83C	G-4059	Rubber Skimmer Gasket (For Set Order 2)	07-4629	G-4386	Commercial R Gasket
ACM-94-5	O-2292	Chlorinator Cover O-ring	07-5846	O-2387	Commercial R Seal Plate O-ring
ACM94-7	O-2208	Chlorine Feeder Valve O-ring	07-5847	O-2389	Commercial R Lid O-ring
ACM-97G	G-3402	Main Drain Gasket	07-5848	O-2139	Commercial R Diffuser O-ring
GAS-1096-G	G-4054	Widemouth Gasket for ACM96 Skimmer	15-2038	O-1056	22" Tank O-ring
WP-83W	G-4056	Regular Gasket for Widemouth Skimmer	15-2038-2	O-1087	Tank O-ring
OMNI			15-2038-3	O-1085	Tank O-ring
0-5960	O-2282	Chlorinator O-ring	15-2122	O-2068	O-ring
ONYX			15-2127	O-1062	18" Tank O-ring
ONHSUPREME	G-5150	Spa Pack Gasket	15-2235	O-1071	16" PF-100 Tank O-ring
ON15	G-4338	1 1/2" Spa Union Gasket	15-2501	O-2217	Valve Adapter O-ring-TA100D
ON20	G-4339	2" Spa Union Gasket	15-2509	G-5079	Square Gasket
ORTEGA (SEE PUREX)			15-4004	O-2283	Triton C-3 Filter O-ring
PAC FAB (DIVISION OF PENTAIR)			15-4005	O-2114	C-3 O-ring
—	O-1031	9/16" X 67 1/2" Tank O-ring	15-4287	O-2102	Valve Shaft O-ring
—	O-1045	O-ring	15-4491	O-2100	1 1/2" Bulkhead O-ring
—	O-2032	8" Trap Lid O-ring	15-4492	O-2282	2" Bulkhead O-ring
—	O-2102	Crankshaft O-ring	15-4493	O-2041	Filter Dome Lid O-ring
—	O-2106	Nautilus Manifold O-ring	15-4494	G-5076	Square Ring
—	O-2106	PVC Backwash Valve Cap O-ring	15-4495	O-2041	Triton II Closure O-ring
—	O-2106	RPZ Pot to Volute O-ring	15-4538	G-4324	2" Bulkhead Fitting Gasket
—	O-2106	Mark Series Center Pipe O-ring	15-4539	G-4296	1 1/2" Super Flow B/H Gasket
—	O-2256	Multiport Valve Shaft Seal O-ring	15-4661	O-2141	Gauge & Air Bleeder Adapter
—	G-3117	Hydro 540 Pump Gasket	15-4693	O-2376	Knob O-ring
—	G-3127	Hydro 650 Model Pump Gasket	15-4827	O-2133	Air Relief O-ring
—	G-3134	Hydro VB-40 Volute Gasket	15-5064	O-2189	Tagelus Stand Pipe O-ring
			15-5564	O-2189	Star O-ring
			17-4704	O-1048	Mytilus/Turbo Tank O-ring
			19-1424	O-2071	Star 40/ Mytilus Bottom Piping O-ring
			19-1474	O-2115	Star DE Filter O-ring
			19-1479	O-2256	Star DE Filter Shaft O-ring
			19-1517	O-2066	Star 50 DE Standpipe O-ring
			19-2031	G-4282	Crankshaft Sleeve Flat Gasket
			19-2032	G-4291	Gasket
			19-2039	O-2220	SCS Spin Filter Crank O-ring

OEM PART# CROSS REFERENCE

FITS OEM#	SSC#	DESCRIPTION
19-2040	O-2264	Crank Cap O-ring
19-2115	O-2082	RM Spin Filter Crank O-ring
19-2122	O-2150	1 1/2" Return Filter O-ring
19-2300	O-2106	Mytillus Connector & Bulkhead O-ring
19-2320	O-2215	Stainless Steel DE Filter O-ring, Bulkhead O-ring
19-2323	O-2106	Filter & Pump Gasket
19-2404	G-4265	SCS Return Sleeve Gasket
19-5004	G-4015	Poly Gasket
19-5007	O-2219	4" Diameter Adapter O-ring
19-5008	O-1037	Old Style Tank Lid O-ring
19-5310	O-1100	Filter Tank O-ring
27-1103	O-2025	Valve Cover O-ring
27-1104	G-5106	Spider Gasket for 1 1/2" Valve
27-1106	G-4362	Mounting Valve Sight Glass Gasket
27-1151	O-2374	Cover O-ring
27-1162	O-2256	Valve Stem O-ring
27-2406	O-2124	2" Hi-Flow Valve Shaft O-ring
27-2511	O-2261	1 1/2" Hi Flow Shaft O-ring
27-2541	O-2292	Valve Body O-ring TA30/35/40/50/60
27-2707	O-2253	1 1/4" Hi Flow Valve Knob O-ring
27-2708	O-2059	Filter Top O-ring/Valve Body O-ring
27-3004	G-3234	Screw Type Valve Cap Gasket
27-3011	O-2024	Brass Valve Shaft O-ring
27-3012	G-5111	1 1/2" Old Style Piston Seal
27-3059	G-5114	2" Piston Seal Ring
27-3060	O-2090	2" PVC Valve Shaft O-ring
27-3062	O-2040	2" PVC Valve Cap O-ring
27-3090	O-2068	2" Slide Valve O-ring
27-3097	G-3271	Brass Backwash Valve Cap Gasket
27-3160	G-5112	1 1/2" New Style Piston Seal
27-3512	O-2302	Nautilus Air Bleeder O-ring
27-3513	O-2302	Air Bleeder Screw O-ring
27-3514	O-2303	Stainless Steel Sand Filter O-ring
27-4494	O-2002	Valve Adapter O-ring
27-5300	O-2332	Full Flow Valve O-ring
27-5333	O-2091	Valve Body O-ring TA100D
31-3225	O-1070	Mitra 11" Tank O-ring
34-4001	MS-201	Pump Seal
35-0002	MS-201	Pump Seal
35-0013	O-2060	Challenger High Pressure Pump Lid O-ring
35-2600	O-2080	Old Style 700 Lid O-ring, Hydro O-ring
35-2600	O-2172	New Style 700 Pump Lid O-ring, P Series Lid O-ring
35-2602	O-2028	New Style 5" H & L Trap O-ring
35-2602	O-2408	Old Style RPZ 590 5" Pump Lid Quad Ring
35-2604	O-2028	590 Glass Pump Lid O-ring
35-2626	O-2262	Backwash Valve O-ring/Volute O-ring
35-2627	G-4104	Backwash Valve Gasket Replaces 35-3500
35-3500	G-3177	Hydro Pot to Volute Gasket-Fiber
35-3500	G-4122	Hydro Pot to Volute Gasket-Rubber
35-3501	G-3107	Hydro B/V Pump Gasket
35-3502	G-3117	540 Pump Gasket
35-3506	G-3112	460-650 Pump Gasket
35-3512	G-3241	880-881 Pot Flange Gasket
35-3513	G-3121	880-881 Pot to Volute Gasket
35-3514	G-3109	880-881 Bracket to Volute Gasket
35-3515	G-3110	Backwash Valve Pump Gasket
35-3525	O-2080	New Style Porpoise Clear Lid O-ring
35-3525	O-2224	Old Style Porpoise Filter Clear Lid O-ring
35-3750	E-6504	Pump/Motor Shaft Extension
35-4001	MS-201	Pump Seal
35-4052	O-2121	540 Pump Lid O-ring
35-4053	O-2266	700 Glass Pump Lid O-ring
35-4533	O-2139	Dynamo, Dynamite Cover O-ring
35-4535	O-2214	Dynamo Bracket Diffuser O-ring
35-4545	MS-200	Pump Seal
35-4571	O-2195	Dynamo Adapter O-ring
35-4634	O-2286	Bracket Diffuser O-ring-After 12/93
35-4894	MS-201	Pump Seal

FITS OEM#	SSC#	DESCRIPTION
35-5030	O-2409	MH Challenger Diffuser Quad Ring
35-5329	O-2046	Old Style Challenger Housing O-ring
35-5329	G-5061	New Style Challenger Front Housing Square Ring
35-5330	O-2226	Challenger Pump Strainer Pot Flange O-ring
35-5331	O-2015	Challenger Diffuser O-ring
35-5332	O-2080	New Style Challenger Pump Lid O-ring
35-5332	O-2172	Old Style Challenger Pump Lid O-ring
35-5619	O-2294	Pinnacle Seal Bracket O-ring
51-3033	G-4031	Skimmer Gasket
51-6231	G-3008	Bermuda Skimmer Gasket
55-2471	G-3400	Liner Sealing Rim Gasket
55-2566	G-3020	Skimmer Gasket
61-4562	G-4616	Washer
63-4568	G-3163	Vinyl Pool Niche Gasket
67-0018	G-3155	Spa Vinyl Niche Gasket
88-500-1	G-5129	Old Style Manifold V-ring (SCS Series Before 1977)
88-500-3	G-5136	Large Manifold V-ring
HL4	O-2240	4" H&L Trap O-ring
HL6	O-2247	Hydro 6" H&L Trap O-ring

PADDOCK

—	O-1225	Clamp Type & Combination O-ring
—	O-2008	Petite Spin Filter Tube O-ring
—	O-2133	Petite Spin Filter Crank O-ring
—	O-2231	Star Clear Tube & Manifold O-ring
—	G-4233	1 1/4" - 1 1/2" Flat Gasket
—	G-4248	2" Flat H&L Gasket
—	G-4254	Trimmer Lid Keyhole Gasket
—	G-4287	3/4" Sight Glass Gasket

PARAPORT

C64057	O-2141	Bleeder Adapter O-ring
C64069	G-4388	Sight Glass Gasket

PEERLESS

—	G-3116	4 Hole Bracket to Pot Gasket
—	G-3211	2 Hole Pot to Volute Gasket
—	G-3257	Bracket to Pot Round Gasket
2665554	MS-162	Pump Seal

PENTAIR

(SEE AMERICAN PRODUCTS, KREEPY KRAULY, PAC FAB, PUREXTRITON & RAINBOW LIFEGUARD)

PLASTILINE

—	O-2100	1 1/2" Union O-ring
—	O-2203	3/4" Union O-ring
—	O-2282	2" Union O-ring

POLARIS

6-412	O-2329	Vac Sweep O-ring
6-505-00	O-2004	O-ring UWF/QD
9-100-5108	O-2287	Hose Nut, Cuffless Hose O-ring
9-100-5132	O-2098	Timer O-ring
9-100-5139	O-2134	Wall Bushing O-ring
9-100-5140	O-2001	Filter Housing O-ring
C-140	O-2124	Thrust Jet O-ring
D-24	O-2144	Quick Connect O-ring
E-30	O-2175	Backup Valve Case O-ring
E-31	O-2175	Backup Valve O-ring-1986-91
E-45	O-2024	Backup Valve Plate O-ring
P-40	O-2024	Pump Shaft O-ring

OEM PART# CROSS REFERENCE

FITS			FITS		
OEM#	SSC#	DESCRIPTION	OEM#	SSC#	DESCRIPTION
P-45	E-6503	Pump/Motor Shaft Extension	31-713	O-1016	7" Lid O-ring
P-55	MS-1000	Pump Seal	31-812	MS-201	Pump Seal
P-95	O-2209	Volute O-ring	31-813	MS-1000	Pump Seal
POOL TENDER			31-814	E-6503	Pump/Motor Shaft Extension
05-009-1005	O-2124	O-ring for All Models	32-248	G-3240	Bronze Strainer to Volute Gasket
POOLSWEEP (SEE ALSO ARNESON)			33-229	O-2189	O-ring Set For Pump (O-2189 & O-2226 Make Set)
E-43	O-2220	Turbo Sweep O-ring	33-248	G-3240	Pot to Volute Gasket
G-32	O-2263	O-ring	33-487	O-2167	Clear Lid O-ring
J-04	O-2144	O-ring	33-489	O-2167	6" Cover O-ring
W-430	O-2011	Leaf Cannister O-ring	35-162	O-2209	Volute O-ring
PRAHER			35-271	G-3220	Bracket to Volute Gasket
T15-E3	O-2211	Cover O-ring	39-271	G-3220	Bronze Pump Gasket
T15-E6	O-2134	Diverter O-ring	39-441	O-2032	8" Trap Lid O-ring
PREMIER			P-136P	O-2060	New Style Clear Lid O-ring
—	O-2068	2" Backwash Valve Valve O-ring	P-13-6P	O-2249	Clear Lid O-ring
—	O-2122	550 Noryl Bracket O-ring	P-2P	O-2134	2" Piston O-ring
—	O-2124	Spin Filter Crank O-ring	P-7515	O-2126	1 1/2" Backwash Valve O-ring
—	O-2124	Shaft Extension O-ring	P-NPL	O-2226	Large Noryl Pump Volute O-ring
—	O-2142	Premier 1 1/2" Cap O-ring	P-NPS	O-2189	Small Pump Volute O-ring-Noryl
—	O-2226	Large & Spa II O-ring	SG-364	G-4310	Sight Glass Gasket
—	O-2249	550 6" Lid O-ring	VB38	G-3275	Volute Gasket
—	O-2604	550 Blue Teflon Coated 6" Lid O-ring	PUREX (PUREXTRITON),		
—	R-6146	555 Noryl Pump Repair Kit	(DIV. OF PENTAIR)		
—	E-6502	Pump/Motor Shaft Extension	—	O-2106	CHD O-ring
—	O-2024	Crank O-ring	—	O-2141	CHD Crank O-ring
—	O-2115	1 1/2" Valve Cap O-ring	—	O-2155	CHD 2" O-ring
—	R-6170	756 Series Pump Repair Kit	—	O-2165	N/S Tahitian Adapter O-ring
—	R-6171	355/225 MK2 Pump Repair Kit	—	O-2240	Eastside 4" H&L Trap O-ring
122	G-4322	Rubber Washer	—	O-2247	Eastside 6" H&L Trap O-ring
21-108	G-4207	Rubber Washer	—	G-3114	Eastside Pump Gasket
21-391	G-3148	2" Cap Gasket	—	G-3126	Eastside Old Style 6 Hole Pot to Volute Gasket
21-500	O-2126	1 1/2" Piston Seal O-ring	—	G-3130	Eastside Old Style 8 Hole Pot to Volute Gasket
21-502	O-2195	1 1/2" Cap O-ring	—	G-3139	Eastside Old Style Volute Gasket
21-505	G-5114	Piston O-ring	—	G-3147	Eastside Seal Well Gasket
23-256	G-4421	Rubber Disc	—	G-3248	Eastside 2 Hole Pot to Volute Gasket
23-671	O-1039	18" Hercules Tank O-ring	—	F-8109	Tahitian Sand Filter O-ring Kit
25-229	O-2226	2" Tailpiece O-ring	—	F-8307	CF-25 & CF-50 Cartridge Filter O-ring Kit
25-311	O-1050	6" Pump Lid O-ring	—	R-6122	L & AA Series Pump Repair Kit
25-313	O-2058	8" Sidewinder O-ring	—	R-6123	C Series Pump Repair Kit
25-575	G-4207	Neptune Sand Filter Gasket	—	R-6124	Aquatron Pump Repair Kit
25-744	O-1083	15" Atlas DE Filter Tank O-ring	—	R-6125	Whisperflo Pump Repair Kit
25-745	O-1042	24" Tank O-ring	70152	G-4268	Index Plate BH Valve Gasket
27-379	G-4283	Hercules Filter Lid Gasket	70155	K-6006	Piston O-ring Kit
27-671	O-1039	18" Tank O-ring	70156	O-2082	O-ring
27-678	O-1014	Hercules II Tank O-ring	70169	G-4271	Bulkhead Gasket
29-113	O-2024	Series 220 Shaft Extension & Crank O-ring	70211	G-5006	OOB7013 Gasket V-Band Lid
29-225	O-2006	Return Spin Filter O-ring	70212	O-2188	OOB7014 Valve Piston O-ring
29-674	O-2195	1 1/2" Tailpiece O-ring	70213	G-5058	New Style Bulkhead Union Ring
29-869	G-4292	Rubber Washer	70213	O-2040	Old Style Bulkhead Union O-ring-00B7027
30-828-750	K-6008	1 1/2" Valve O-ring/Gasket Kit	70238	O-2106	OOB7001 Bulkhead O-ring
30-828-754	K-6009	2" Valve O-ring/Gasket Kit	70247	O-1210	Control Plate Gasket/O-ring
31-157	O-2009	300 Series Swivel O-ring	70345	O-2155	O-ring
31-158	O-2262	Volute O-ring	70393	6203	#203 AH Bearing
31-159	O-2026	Volute O-ring	70394	6304	#304 AH Bearing
31-160	O-2138	100 Series Adapter O-ring	70935	G-4149	Cover Gasket
31-161	O-2187	200 Series MK2 Volute O-ring	70940	G-3255	Pot to Volute L Series Pump Gasket
31-162	O-2143	Booster Pump Volute O-ring	70941	G-3247	Uniseal & L Series Bracket to Volute Pump Gasket
31-184	E-6503	Pump Shaft Extension	70942	G-4266	Tropic Inlet/Outlet Gasket For All Models
31-256	O-2041	O-ring	70943	G-4123	C Series Pot to Volute Gasket
31-276	G-3256	1/2-2 HP Volute Gasket	70943	G-4247	Flange Gasket
31-346	O-2099	4" Pump Lid O-ring	70944	G-4430	Valve Gasket
31-418	O-2306	Renegade 725 O-ring	70945	G-5126	Light Lens Gasket
31-420	O-2306	Renegade Volute O-ring	70947	G-4164	Sunlite Niche Face Ring Gasket
31-486	O-2228	5" Cover O-ring	70951	G-4329	Tube Seal Gasket

OEM PART# CROSS REFERENCE

FITS OEM#	SSC#	DESCRIPTION
70952	G-3175	Air Relief Fitting Gasket
71416	O-2138	Eastside Seal Plate O-ring
71417	O-2209	AT Series Pump B/V O-ring
71418	O-2079	JT Adapter O-ring
71419	O-2208	Whisperflo Lock Screw O-ring
71420	O-2086	O-ring for Soltron
71421	O-2247	PJ-18 Pump Lid O-ring
71422	O-2041	Aquatron Lid O-ring
71423	O-2249	Flange O-ring
71423	O-2604	Blue Teflon Coated Flange O-ring
71424	O-2189	Cap O-ring
71426	O-2165	Collar & Rotor O-ring
71427	O-2209	Aquatron Pump B/V O-ring
71428	O-2220	Tahitian Cap & Rotor Shaft O-ring
71430	O-2144	O-ring
71431	O-2231	800 Series Manifold O-ring
71432	O-2155	2" Valve Cap O-ring
71433	O-1067	C-18 Cover O-ring
71434	O-2221	Noryl Rotor Shaft O-ring
71435	O-2124	Noryl Rotor Shaft O-ring
71436	O-2090	Sel. Valve Shaft O-ring
71437	O-1039	CF-100 Tank O-ring
71439	O-1029	SM 4000 Tank O-ring
71440	O-2189	Coupling O-ring
71441	O-1063	CF-25, 50 & 700 Tank O-ring
71442	O-1073	2000 Series Tank O-ring
71442R	O-1093	Tank O-ring-Red Line CF-100, SM-1000, 2000
71443	O-1074	800 Series Tank O-ring
71444	O-2103	Whisperflo Diffuser O-ring
71445	O-2216	Whisperflo Seal Plate O-ring
71446	G-3157	Old Style Vinyl Niche Gasket
71447	O-2067	PA Series Pump O-ring
71448	O-2034	Valve Body O-ring
71449	O-2223	Tahitian Filter Shaft O-ring
71722	G-5117	Piston O-ring
71723	MS-372	Pump Seal
71725	MS-360	Pump Seal
71728	MS-201	Pump Seal
71733	MS-100	Pump Seal
71733	MS-200	Pump Seal
71733	MS-501	Pump Seal
71734	MS-1000	Pump Seal
72187	G-4285	Eastside Pump Water Slinger Gasket
72551	O-2175	Mixing Valve Liftlock O-ring
72552	O-2220	Shaft Liftlock O-ring
72553	O-2030	Ortega 1 1/2" Cover Seal
72554	O-2044	Ortega 2" Cover Seal O-ring
72555	O-2024	Ortega Valve Stem O-ring
72557	O-2243	Ortega Valve Equalizer O-ring
72559	O-2040	1 1/2" Ortega Valve Cap O-ring
72560	O-2270	2" Ortega Valve Cap O-ring
72999	G-3220	Guardex Washer-Fiber
72999	G-4428	Guardex Washer-Rubber
73270	O-1154	Filter Tank O-ring
74021	O-2234	CFM Manifold O-ring
75114	G-4624	Ortega Rubber Washer
75713	O-2208	Whisperflo O-ring
B-94	O-2282	Regular Lid O-ring
B-94	G-5008	Square Cut Ring-Aqua Brominator CB8-4 to CB8-45
CB8-45	G-5008	Hydrotech Square Cut Ring
P-10630	G-3253	BT Series Backwash Valve Pump Gasket
P-10675	G-3243	VF30 Gasket
P-11125	G-4245	Tropic Inlet/Outlet Heater Gasket
P-11200	G-4129	Flo Valve Gasket
P-11250	G-4416	Valve Gasket
P-24275	O-1063	Filter Lid O-ring
P-24305	O-2106	Center Tube O-ring
P-26136	O-2243	Ortega Equalizer O-ring

FITS OEM#	SSC#	DESCRIPTION
P-28050	MS-1000	Pump Seal
P-29300	MS-201	Pump Seal

RAINBOW LIFEGUARD (DIV. OF PENTAIR)

FITS OEM#	SSC#	DESCRIPTION
—	F-8325	3 & 4 OZ. Cartridge Filter O-ring Kit
17-2009	O-2114	Cartridge Filter Lid O-ring
17-2009	O-2522	Chlorinator Lid Viton O-ring
17-2015	G-4279	Lifeguard Cartridge Filter Gasket
17-2033	G-4327	Tube Fitting Gasket
17-2221	O-2135	RTL Filter Air Vent Valve O-ring
17-2222	G-4337	Cartridge Gasket
17-2223	O-2095	25 Sq. Ft. Filter Lid O-ring
17-2224	O-2135	O-ring
17-2263	G-4393	1/2" Saddle Gasket
17-2319	O-2112	320 Chlorinator Base O-ring
17-2393	O-2082	DSF Skimmer Access Plug O-ring
17-2451	O-2264	Check Valve O-ring
17-2470	G-3036	DSF Skimmer Rear Gasket
17-2471	G-3002	DSF Skimmer Front Plate Gasket
172541	G-3183	Dynamic Lock Gasket
18608	O-2041	Leaf Trap O-ring
18658	G-4621	Leaf Trap Gasket for Cartridge
21-1236	O-2041	180 Leaf Trap Lid O-ring
21-1366	O-2041	In Line Leaf Trap Lid O-ring
33-0017	O-2141	Dynamic Chlorinator O-ring
R37009	O-2326	Concorde Motor Housing O-ring
R37121	O-2324	Concorde Plate O-ring

RAYPAK

—	O-2024	Manual By-Pass O-ring
—	O-2040	U-G #H O-ring
—	O-2040	Solar Valve Body Union O-ring
—	O-2102	Control Well O-ring
800004	G-3246	1 1/2" Unitherm Governor Gasket
800007	G-3265	2" Unitherm Gasket
800014B	G-4314	Gemini Tube Seal Gasket
800031	O-2124	Bypass Manual O-ring
800075	G-4420	Heater Gasket
800080B	G-5036	2" Flange Gasket
800086	G-4346	155B Versa Gasket
800086B	G-5002	1" Square Cut O-ring
800104	O-2134	Raytemp O-ring For Piston Valve
800164	G-4246	Element Gasket
800187	G-4432	Heater Gasket
800204	G-4408	Bypass Gasket
800276	G-4357	WHG 55A Gasket

REGAL

G-202	G-4312	Chlorinator Gasket (For Kit Order 2)
G-203	G-4205	Chlorinator O-ring
G-204	G-4232	Chlorinator Gasket
S-301	O-2503	Chlorinator Viton O-ring
S-302	O-2507	Chlorinator Viton O-ring
S-401	O-2520	Chlorinator Viton O-ring
S-402	O-2506	Chlorinator Viton O-ring
S-403	O-2502	Chlorinator Viton O-ring
S-404	O-2124	Chlorinator O-ring
S-405	O-2259	Chlorinator O-ring
S-406	O-2129	Chlorinator O-ring
S-407	O-2131	Chlorinator O-ring
S-408	O-2005	Chlorinator O-ring
S-409	O-2226	Chlorinator O-ring
S-410	O-2124	Chlorinator O-ring
S-411	O-2505	Chlorinator Viton O-ring
S-412	O-2516	Chlorinator Viton O-ring
S-413	O-2051	Chlorinator O-ring

OEM PART# CROSS REFERENCE

FITS	OEM#	SSC#	DESCRIPTION
RICHARDSON (SEE ALSO E-Z CHLOR)			
—	O-1119		18" Sand Filter O-ring
—	O-1138		22" Tank O-ring
—	O-1139		Cartridge O-ring
—	O-2134		Sand Filter Valve Adapter O-ring
—	G-4360		Thick Sand Filter Gasket
—	G-4361		Thin Sand Filter Gasket
4546-001	O-1153		Cartridge O-ring
5099-125	O-1152		18" Tank O-ring
5099-135	O-1076		22" Filter Tank O-ring
5099-149	O-2278		Sand Lid O-ring
5099-504	G-4395		Air Bleeder Gasket
5099-518	G-5064		Sand Gasket
5099-525	O-2152		1/2" Valve Adapter O-ring
5099-529	O-2002		2" Sand Valve Adapter O-ring
5535-101	O-2058		Sand Filter O-ring
R-44	O-1119		O-ring
SAURERMAN			
—	O-1020		Small Tank O-ring
—	O-1026		Large Tank O-ring
—	O-2006		Manifold O-ring
—	O-2009		1 1/2" Tube O-ring
—	O-2106		2" Tube O-ring
—	O-2141		2" Tube O-ring
—	O-2231		Backwash Valve Valve O-ring
SEARS (HOMART)			
—	G-3118		Sprinkler Gasket
259-043	MS-162		Pump Seal
42G2377W	MS-100		Pump Seal
W6476	MS-162		Pump Seal
SEASON MASTER			
SMS-1023G	G-4290		Skimmer Wall Fitting Gask(For Kit Order 2)
SMS-1094G	G-4001		Face Plate Gasket (for Kit Order 2)
SLINGERS (WATER SLINGERS)			
—	G-4253		Water Slinger-1 1/4" OD x 11/32" ID
—	G-4256		Water Slinger-1 3/4" OD x 13/16" ID
—	G-4263		Water Slinger-1 5/32" OD x 7/16" ID
—	G-4285		Water Slinger-1 1/4" OD x 5/8" ID
—	G-4601		Water Slinger-1 1/2" OD x 1/2" ID
—	G-4629		Water Slinger-1 3/8" OD x 1/2"ID-For 48 Frame Above Ground Pumps
SONFARREL (SEE MARTEC)			
SOUTH PACIFIC			
—	O-1022		Old Style White Lid O-ring
—	O-1027		New Style Brown Lid O-ring
—	O-2107		Old Style Brown Lid O-ring
SOUTH SEAS			
—	G-3204		Outlet Heater Gasket
—	G-4224		Small Rubber Gasket
—	G-4242		Bypass Gasket
—	G-4255		Large Rubber Gasket
—	G-4414		Inlet Bypass Gasket
—	G-5043		Tube Gasket
VB11	G-4011		Inlet Heater Gasket
VB12	G-4023		Outlet Heater Gasket
SPECK			
2020341210	O-2059		O-ring
2301001013	G-4139		BaduJet/Stream Gasket

FITS	OEM#	SSC#	DESCRIPTION
2301002025	G-4342		BaduJet/Stream Gasket
2302002060	G-4140		BaduJet IT Gasket
2302002062	O-2141		BaduJet O-ring
2303002002	G-4138		Jet Gasket
2920141210	O-2071		Casing O-ring, 410 Lid O-ring, Etc.
2920141220	O-2091		410 Casing O-ring
2920141230	O-2220		Filter Plug O-ring
2920141240	O-2141		Model 90 Drain Plug O-ring
2920141250	O-2188		Casing O-ring Model 420
2920241210	O-2308		O-ring
2920241220	O-2152		Model 440 Union O-ring
2920341220	O-2304		Model 400 2 Bolt O-ring
2920341225	O-2305		Model 400 4 Bolt O-ring
2920741210	O-2249		Model 423 Lid O-ring
2920741270	O-2010		Model 423 Tank O-ring
2920841210	O-2304		433T Lid O-ring
2920941210	O-2293		Lid O-ring
2921141210	O-2304		90 Lid O-ring
2921141220	O-2307		Model 90 Casing O-ring
2921641210	O-2345		E91 Pump Lid O-ring
2923141000	G-4448		Model 21-80 Gasket
2923441200	O-2221		Model 21-80 O-ring
2923541220	O-2024		Pump Housing O-ring
2926999990	G-4136		Sand/DE Filter Rim Gasket
2991300001	O-2091		913 Casing O-ring
2991300002	O-2056		Badustar 913 Diff. O-ring
2991300003	O-1083		Badustar 913 Lid O-ring
2991300004	O-1140		Badustar 913 Cartridge O-ring
2991300005	O-2200		Badustar 913 Cartridge O-ring
2991500001	O-2381		Bearing O-ring
412.9	O-2141		Model 420 Drain Plug O-ring
60603-200	MS-200		Pump Seal for E-91
SPIN RITE			
—	O-2006		Collection Tube O-ring
—	O-2024		Crank O-ring
STA RITE			
—	O-2002		PMKGFV 15-20-25-33 Collection O-ring
—	O-2010		Unitrol Valve Piston O-ring
—	O-2025		PDC Bottom O-ring
—	O-2041		Delrin and Sand O-ring
—	O-2041		Sand Filter Cover O-ring
—	O-2082		31B0035 Index Plate O-ring
—	O-2082		Index Plate Small O-ring
—	O-2106		Dep. 83 Valve Adapter O-ring
—	O-2128		Delrin Hi Prime H&L O-ring
—	O-2135		MK23 Crank O-ring
—	O-2150		Vertifilter Manifold O-ring
—	O-2165		Float Valve O-ring
—	O-2188		Valve Piston O-ring
—	O-2211		Dial Valve O-ring
—	O-2240		4" Old Style Pump Lid O-ring
—	O-2247		Old Style 6" Lid O-ring
—	O-2252		XL-VII Bracket to Volute O-ring
—	O-2280		Plastic Slide Valve Cap O-ring
—	O-2280		Index Plate Large O-ring
—	O-2282		HRV 24 O-ring
—	O-2405		Spin Filter Tube Quad Ring
—	O-2411		Upright Spin Crank Quad Ring
—	G-3115		VB35-1 Submersible Pump Gasket
—	G-3119		D Series Pump Gasket
—	G-4444		Aqua Flyte H&L Gasket
—	G-5006		Ring For HRP36 Filter
—	G-5058		Ring For HRP36 Bulkhead Connection
—	F-8116		High Rate 36" Sand Filter O-ring Kit
—	F-8117		Pantera, T-HRP Sand Filter O-ring Kit
—	F-8118		Separation Tank O-ring Kit

OEM PART# CROSS REFERENCE

FITS			FITS		
OEM#	SSC#	DESCRIPTION	OEM#	SSC#	DESCRIPTION
—	F-8205	DEP36, HRP20, HRP20-01B Verticle DE O-ring Kit	24753-05	O-1007	DEP-25 216, 108, 72 Cartridge O-ring-Fits 16"
—	F-8206	DEP51, HRP24, HRP24-01B Verticle DE O-ring Kit	25575-0114	O-2135	Drive Shaft O-ring
—	F-8207	DEP83, HRP30, HRP30-01B Verticle DE O-ring Kit	27001-0060S	O-1157	System 3 Cord O-ring (Pre-3/97)
—	F-8208	DES25, HRS16-01 Vert. Sand & DE O-ring Kit	27001-0061S	O-2086	Filter O-ring
—	F-8209	DES36, HRS20-01 Vert. Sand & DE O-ring Kit	2PLL	G-4274	Light Lens Gasket
—	F-8210	DES51, DES60 HRS24-01 Sand & DE O-ring Kit	31935-0001	O-2046	Posi Flo II Lid O-ring
—	F-8318	35, 50 S/F Posi-Flo Cartridge Filter O-ring Kit	33450-8041	G-3411	Commercial Volute Suction Gasket
—	F-8319	70, 100 S/F Posi-Flo II Cart. Filter O-ring Kit	33450-8042	G-3410	Commercial Volute Discharge Gasket
—	F-8320	135 S/F Posi-Flo Early & Late Cart. O-ring Kit	33455-1047	G-5072	Impeller Screw Gasket
—	F-8321	TXC25, 25B, 50, 50B, 75, 100 Cart, O-ring Kit	33455-8043	G-3408	Commercial Impeller to Shaft Washer
—	R-6109	Duraglass/Maxiglass Pump Repair Kit	33455-8044	G-3409	Commercial Impeller to Shaft Sleeve Gasket
—	R-6110	Cast Iron Pumps Repair Kit	35505-0114	O-2135	Crank Shaft O-ring
—	R-6133	Maxi-Glas II & Dura-Glas II Pump Repair Kit	35505-0114	O-2406	Crank Shaft Quad Ring
—	R-6134	PE, PEA, P2R, P2RA, AJ Pump Repair Kit	35505-0198	O-2175	3 Port Actuator O-ring
—	R-6135	1 1/2" & 2" Universal Slide Valve Repair Kit	35505-0239	O-2254	Skimmer Tube O-ring
—	R-6136	CF, CFA, CF6 Pump Repair Kit	35505-0314	O-2188	Q30 MK O-ring
—	R-6144	Dynaglass & J Pump Repair Kit	35505-0422	O-1082	Seal Plate Housing O-ring
—	R-6150	Flo Tech, Aquatools, Dynaglass Pump Repair Kit	35505-1007	O-2019	Hydro Valet Face Plate Inlet O-ring
—	O-2228	5" Clear Lid O-ring	35505-1009	O-2222	Hydro-Valet Face Plate Inlet O-ring
—	G-3119	D Series Pump Gasket	35505-1116	O-2082	Piston Assembly O-ring
—	K-6006	31B0024 O-ring Repair Kit	35505-1121	O-2096	Dial Valve O-ring
—	O-2172	XLVII H & L Pot O-ring	35505-1152	O-2090	Dial Valve Shaft O-ring
—	O-2082	31B0035 Index Plate O-ring	35505-1157	O-2102	Knob O-ring
05057-0667	G-4148	Light Niche Gasket	35505-1175	O-2009	Valve Connector O-ring
05057-118	G-5124	Light Lens Gasket	35505-1223	O-2239	2" Valve Stem O-ring
05103-0101	G-4614	Niche Gasket	35505-1228	O-2255	Dial Valve O-ring
05161-0006	G-4159	Niche ABS Liner Gasket	35505-1233	O-2142	Index Plate O-ring
07017-0079	G-3401	Drain Gasket	35505-1236	O-2231	Sil. Seal & Capri Return O-ring
0956-0150	G-4050	Standard Skimmer Gasket	35505-1238	O-2189	FCP Cartridge Drain Plug O-ring
0956-0152	G-4060	Above Ground Skimmer Wide Mouth Gasket	35505-1245	O-2111	Turbo Clean Head O-ring
14962-21	G-5012	Caprice Valve 1 1/2" Square Ring	35505-1246	O-2280	Turbo Clean Head O-ring
14962-35	O-2211	Large O-ring For Kit	35505-1263	O-2042	1 1/2" Piston O-ring-Brass Pucks-Old Style
14962-35	O-2255	Small O-ring For Kit	35505-1263	O-2138	XLII Pump Seal Plate O-ring
14971-0011	G-4619	2" Multiport Valve Sight Glass Gasket	35505-1266	O-2088	XLIII Pump Seal Plate O-ring
16503-07	O-2088	Body O-ring	35505-1272	O-2041	O-ring
16800-11	G-3228	Pump Gasket	35505-1273	O-2041	Float Valve O-ring
16800-29	G-3228	XLVI Old Style Gasket	35505-1275	O-2209	Cover O-ring For M/V WC112-147
16800-29	E-6506	Pump/Motor Shaft Extension	35505-1281	O-2022	Skimmer O-ring
16920-12	O-2095	XL-VII Pump O-ring	35505-1313	O-2134	2" Piston O-ring
17150-0007	G-4615	4" Trap Gasket	35505-1317	O-2100	Fill Cap & MF23 Tube O-ring
23382-13	O-1043	Model X Filter O-ring	35505-1318	O-2010	Piston Plastic Slide Valve-2"
23383-13	O-1117	SilverSeal, Capri Tank O-ring	35505-1323	O-2120	Roto-trol Valve O-ring
23383-15	O-1038	X Model Tank O-ring	35505-1332	O-2114	O-ring
23568-15	O-1048	Separation Tank O-ring	35505-1338	O-2121	XLVI Pump Lid O-ring
24240-04	O-1004	Cobra & Falcon Body O-ring	35505-1344	O-2228	O-ring
24700-68	O-1133	16" DES-25, HRS-16 Tank O-ring	35505-1365	O-1010	O-ring
24700-69	O-1084	Tank O-ring	35505-1401	O-2004	Index Plate & Piston O-ring-Plastic Pucks
24700-71	O-1118	Tank O-ring	35505-1401	O-2042	Index Plate & Piston O-ring-Brass Pucks
24700-72	O-1015	20" DES-36, HRS-20 Tank O-ring	35505-1402	O-2266	O-ring
24700-73	O-1002	24" DES-51 & 60 Tank O-ring	35505-1408	O-2025	XL-VII Pump Volute O-ring
24700-74	O-1033	Tank O-ring	35505-1409	O-2041	Skimmer Lid O-ring
24750-0006	O-1151	HRPB O-ring	35505-1412	O-2297	Lid O-ring Multiport Valve Side Mount O-ring
24750-05	O-1106	20" DEP-36 Fiberglass Filter O-ring	35505-1421	O-2297	Lid O-ring For 2" Side Mount Valve
24751-0006	O-1155	HRPB O-ring	35505-1423	O-2092	System 3 Sand Adapter O-ring
24751-05	O-1009	24" DEP-51 Fiberglass Filter O-ring	35505-1424	O-2002	System 3 O-ring
24752-0006	O-1156	HRPB O-ring	35505-1425	O-2114	System 3 O-ring
24752-05	O-1046	30" DEP-83 Fiberglass Filter O-ring	35505-1426	O-2386	Impeller Screw O-ring
			35505-1428	O-2040	Elbow Assembly O-ring
			35505-1429	O-2231	Elbow Assembly O-ring
			35505-1437	O-2086	ABG Pump Trap Lid O-ring
			35505-1438	O-2266	ABG Pump Seal Plate O-ring
			35505-7430	O-2007	O-ring
			35505-7432S	O-2094	Pool Heater Manifold O-ring
			35515-0114	O-2406	Crankshaft Quad Ring
			35515-0314	O-2188	Q30 MK Adapter O-ring
			35515-0317	O-2412	Filter Collection Tube O-ring
			35515-0318	O-2419	Collection Tube Quad Ring

OEM PART# CROSS REFERENCE

FITS			FITS		
OEM#	SSC#	DESCRIPTION	OEM#	SSC#	DESCRIPTION
35515-0514	O-2419	Collection Tube Quad Ring	U9-046	O-2167	6" Pump Lid O-ring
35515-1296	O-2403	Valve Connector Quad Ring	U9-103	MS-162	Pump Seal
35515-1297	O-2409	CFP Cartridge Filter Valve Connector Quad Ring	U9-105	O-1032	11" Trap Lid O-ring
35575-1114	O-2208	Shaft O-ring-MK37, 47, 57 Series	U9-114	O-2252	Pump O-ring
37400-0027S	MS-851	Pump Seal for Max-E-Glass II, Dura-Glas II	U9-145	O-1039	18" Tank O-ring
42001-0066S	G-3284	Ignitor Gasket	U9-147	O-2024	Bronze Cap Valve O-ring
489031	G-5047	Head Quad Ring	U9-151	O-2142	1 1/2" Piston O-ring
77707-0117	O-2261	Pool Heater O-ring (for kit order 6)	U9-152	O-2134	2" Valve O-ring
8490-31	G-5047	Head Quad Ring	U9-154	O-2008	1 1/2" Return Filter O-ring
8652-5	G-4012	U-3 Skimmer Face Plate Gasket	U9-156	O-2002	2" Return Hub O-ring
8653-7	G-4008	Skimmer Gasket	U9-160	O-1008	20" Tank O-ring
AS-201	MS-201	Pump Seal	U9-161	O-2218	5" Pump Trap Lid O-ring
C110-17	E-6502	Pump/Motor Shaft Extension	U9-165	O-1042	24" Tank O-ring
C20-009	G-3162	Pump Gasket	U9-167	O-2252	Pump O-ring
C20-015	G-4436	Pump Gasket	U9-171	O-2107	8" Trap Lid O-ring
C20-019	G-3240	Dura Glass Pump Gasket	U9-174	O-2142	1 1/2" Valve O-ring
C20-021	G-3151	Pump Gasket	U9-175	O-1006	Separation Tank O-ring
C20-031B	G-4412	LT Series Seal Plate Gasket	U9-191	O-1014	Separation Tank O-ring
C20-035	G-3023	Delrin Plastic Volute Gasket	U9-199	O-2231	Diffuser O-ring
C20-046	G-3164	Pump Gasket	U9-200	O-1011	PLBC Tank O-ring
C20-072	G-3249	Thin Pump Gasket	U9-203	O-2159	Sand Filter O-ring
C20-072	G-3256	Thick Pump Gasket	U9-205	O-2165	Sand Filter Riser Tube O-ring
C20-077	G-3261	C & CC Series Pump Gasket	U9-207	O-2128	Cover O-ring
C20-079	G-3226	AJ Series Gasket	U9-211	O-2266	Sand Filter Cover O-ring
C20-086	G-3118	Sears Sprinkler Gasket	U9-221	O-2090	WC-212-7 Valve Cap O-ring
C20-087	G-3123	Well & Irrigation Pump Gasket	U9-226	O-2195	Duraglass Diffuser, Quantum Spa, Cart. O-ring
C20-100	G-3199	CC Gasket	U9-228	O-1082	Dura Glass Pump Clamp O-ring
C20-101	G-3197	CC Seal Gasket	U9-228A	O-2306	P2R Pump Housing O-ring
C20-102	G-3258	ACP Pump Seal Plate Gasket	U9-229	O-2060	Dura Glass Pump Lid O-ring
C20-103	G-3241	Duraglass Pump Gasket-Fiber	U9-239	O-2030	Pump O-ring
C20-103	G-4411	Duraglass Pump Gasket-Rubber (Larger Bolt Holes)	U9-240	O-2044	Pump O-ring
C20-103	G-4441	Duraglass Pump Gasket-Rubber	U9-241	O-2217	Pump O-ring
C20-123	G-4441	Trap Outlet Gasket	U9-243	O-2067	Cover O-ring
C69-002	G-4206	Duraglass Pump Slinger Gasket	U9-244	O-2110	O-ring
C69-002	G-4253	Water Slinger Gasket (Replaces N69-001)	U9-245	O-2009	Plunger Top O-ring
C69-012	G-4256	C Pump Water Slinger Gasket	U9-259	O-1036	Sep. Tank O-ring
CN20-035	G-3259	Pump Gasket	U9-265	O-2271	C Series Shaft O-ring
G20-012	G-3208	Well & Irrigation Pump Gasket	U9-269	O-2189	Cartridge Filter Drain Plug O-ring
J20-009	G-3129	Well & Irrigation Pump Gasket	U9-285	O-2150	Trap Adapter O-ring
J20-011	G-3136	Well & Irrigation Pump Gasket	U9-295	O-2099	Pump Cover O-ring
J20-012	G-3208	Well & Irrigation Pump Gasket	U9-301	O-2047	Posi Flo Top O-ring
J20-016	G-4426	Well & Irrigation Pump Gasket	U9-309	O-2001	Plunger O-ring
L20-40	G-4620	PLBC Small Gasket	U9-357	O-2266	Dura Jet Seal Plate O-ring
L21-001	G-5034	Pump Diffuser Ring	U9-358SS	MS-201	Pump Seal
N20-025	G-3233	Gasket	U9-359	O-2024	Posi Flo II Air Release O-ring
N20-026	G-3236	Pump Gasket	U9-362	O-2111	Valve O-ring-WC212
N20-035	G-3259	Pump Gasket	U9-366	G-3032	U3 Auto Skimmer Gasket
N20-039	G-3229	Pump Gasket	U9-369	O-2094	V/F Tank Flange O-ring
N69-001	G-4253	Water Slinger Gasket (C69-002 Replaces This)	U9-370	O-2259	Lateral O-ring
P-61	MS-100	Pump Seal	U9-371	O-2134	Drain Cap O-ring
P64-057	O-2141	Paraport Valve Seal O-ring	U9-373	O-2305	Dynaglass Seal Plate O-ring
P64-069	G-4205	P/V Sight Glass Gasket	U9-374	O-2002	Diffuser O-ring
PP11-00	R-6110	Cast Iron Pumps Repair Kit-Fits All CK & CRA4	U9-375	O-2247	Maxi Glass II Trap O-ring
PS20-011	G-4406	Top Plate Gasket	U9-376	O-2142	Maxiglas II Shaft O-ring
PS20-018	G-4406	Pump Gasket	U9-389	O-1011	PLBC Tank O-ring
Q4112	O-2406	Large Crank Quad Ring	U9-399	O-2247	Maxi Glass Trap O-ring
Q4327	O-2405	Manifold Quad Ring	VB43	G-3222	Pump Gasket
S04757	G-3412	Commercial Volute to Bracket Gasket	WC20-02	G-4204	Filter Gasket
U109-006A	MS-162	Pump Seal	WC20-03	O-1227	6.5" Separation Tank Gasket
U109-047	MS-201	Pump Seal	WC20-04	G-5024	9.5" Separation Tank Gasket
U109-068	MS-163	Pump Seal	WC20-05	G-4115	Filter Gasket
U109-093SS	MS-100	Pump Seal	WC20-11	G-4336	Filter Gasket
U109-136SS	MS-1000	Pump Seal	WC20-15	G-4239	Sand Filter Gasket
U109-170	MS-703	Pump Seal	WC20-16	G-4105	Sand Filter Gasket
U109-220	MS-381	Pump Seal	WC20-24	O-2195	Pump O-ring
U9-045	O-2099	4" Pump Lid O-ring	WC298-88	K-6007	PVC Valve Repair Parts Kit
			WC9-002	G-4387	Sight Glass Gasket
			WC9-003	O-1010	Cartridge Filter Tank O-ring
			WC9-007	O-2282	Sand Filter O-ring

OEM PART# CROSS REFERENCE

FITS		
OEM#	SSC#	DESCRIPTION
WC9-011	O-1059	Cartridge Filter O-ring
XL-VII	O-2172	H&L Pot O-ring
STARBRIGHT		
—	O-1028	SEP Tank O-ring
—	O-1037	20" Tank O-ring
—	O-1090	Tank O-ring
—	O-2177	Skim Filter Manifold O-ring
—	O-2406	Crank Quad Ring
SUNDANCE		
6560-043	O-1150	Hi Flo Heater O-ring
6560-044	O-2226	Hi-Flo Heater Union Fitting O-ring
6560-045	G-4044	Hi Flo Heater Box Gasket
6560-046	G-4045	Hi Flo Heater Element Gasket
SUPERFLOW		
—	O-1085	PF-50, SCS
—	O-1087	PF-50, SCS
SWIMLINE		
14118	O-1225	Gasket
SWIMQUIP (SEE STA RITE)		
SWIMRITE		
—	O-1040	50-57 Verticle Filter O-ring
—	O-2002	Lid O-ring
—	O-2121	H&L Lid O-ring
—	O-2124	Shaft O-ring
—	O-2228	5" Clear Lid O-ring
—	O-2255	Old Style Lower Piston O-ring
—	E-6503	Pump/Motor Shaft Extension
14-828-381	G-4320	Block Hose Washer
28-828-021	O-2038	O-ring
28-828-324	G-4419	Bracket Mounting Gasket
28-828-325	G-4251	Washer
28-828-667	O-2115	Return Hub O-ring
28-828-668	O-2029	Ret. End Bell O-ring
28-828-671	O-1039	18" Filter Tank O-ring
28-828-675	O-2024	Spin Crank O-ring
28-828-678	O-2006	Spin Filter Manifold O-ring
28-828-679	O-2115	Return O-ring
28-828-681	O-2264	Marathon Grid O-ring
28-828-686	O-1130	Ventirite Series Tank O-ring
28-828-687	O-1073	18" Ventirite Tank O-ring
28-828-689	O-1132	Marathon Filter O-ring
28-828-745	O-1042	24" Satelite Tank O-ring
30-828-670	O-2090	Valve Stem O-ring
30-828-678	O-1014	12" Separation Tank Cartridge Lid O-ring
30-828-750	O-2024	1 1/2" x 1 1/2" Shaft O-ring
30-828-752	O-2126	1 1/2" Piston O-ring
30-828-752	O-2142	Valve Cap O-ring
30-828-753	O-2134	2" Piston O-ring For Autoflow Valve
30-828-756	O-2024	1 1/2" V Crank Pump O-ring
30-828-757	O-2126	1 1/2" Piston O-ring
30-828-758	O-2142	Autoflow Cap O-ring
30-828-759	O-2134	2" Piston O-ring
30-828-911	G-4204	Sight Glass Gasket
36-828-114	G-4320	Heater Gasket
36-828-122	G-4329	Tube Heater Gasket
36-828-136	G-4019	Mixing Box Heater Gasket
36-828-146	G-4019	Mixing Box Cover Gasket
36-828-266	G-3206	Pool Control Gasket
36-828-280	G-4275	Washer
36-828-453	G-4208	Washer
38-828-680	O-1063	10" Separation Tank O-ring

FITS		
OEM#	SSC#	DESCRIPTION
38-828-752	O-2133	Cap O-ring
60-828-274	G-3275	P/V Pump Gasket
60-828-276	G-3256	Backwash Valve Pump Gasket
60-828-486	O-2028	5" Clear Lid Gasket
60-828-487	O-2054	7" Clear Lid Gasket
60-828-713	O-1016	7" Stainless Steel Pump Lid O-ring- 24.5" C/L
60-828-713	O-1035	7" Stainless Steel Pump Lid O-ring- 21.25" C/L
60-828-715	O-2218	5" Pump Lid O-ring
60-828-813	MS-1000	Pump Seal
64-828-946	O-1091	10" Series II Gasket
70-828-827	O-1018	Large O-ring
70-828-828	O-2041	Small O-ring
SYLVAN		
59200236	G-3031	Old Style Vinyl Skimmer Gasket
59201200	G-4363	Throttling Plug Gasket
TANK O-RINGS (GENERIC)		
—	O-1115	13" Tank O-ring
—	O-1066	14" Tank O-ring
—	O-1102	15" Tank O-ring
—	O-1041	16" Tank O-ring
—	O-1114	17" Tank O-ring
—	O-1119	18" Tank O-ring
—	O-1110	19" Tank O-ring
—	O-1106	20" Tank O-ring
—	O-1042	24" Tank O-ring
TAYLOR		
—	G-4423	Aqualite PL-89 1603 Gasket
TELEDYNE LAARS (SEE LAARS)		
TESCO		
—	O-2111	M/A Feeder Cap O-ring
F-35	O-2110	Pure Water Feeder Lid O-ring
H-301	O-2011	Widget Lower Case O-ring
H-301	O-2023	Widget Upper Case O-ring
UNIVERSAL		
—	O-1039	Filter Tank O-ring
—	O-1095	Universal Skid Pack Filter Tank O-ring
—	O-1225	Lens Gasket
—	O-2024	Stem & Crank O-ring
—	O-2126	Valve Piston O-ring
—	O-1216	Lens Gasket
—	R-6115	5 Spoke Multiport Rebuild Kit-SP-710/712 After1976
—	R-6116	6 Spoke Multiport Rebuild Kit SP710/711 1969-75
VICO		
PPBFV/OR	O-2209	Big Foot Pump O-ring
PPSFSEAL	MS-201	Pump Seal
PPSFV/OR	O-2212	Super Flo Pump O-ring
PPUFVOR	O-2026	Ultrajet O-ring
PPULPLUGOR	O-2024	Ultrajet Pump Plug O-ring
PPWWVO/R	O-2005	Volute O-ring
UPULO/R2	O-2195	Ultra Flow 2" Union O-ring
VITA		
—	O-2086	Heater Housing O-ring

OEM PART# CROSS REFERENCE

FITS OEM#	SSC#	DESCRIPTION
WALLACE & TIERNAN		
24161	O-2503	Chlorinator Viton O-ring
25900	O-2521	Chlorinator Viton O-ring
26234	O-2506	Chlorinator Viton O-ring
26345	O-2519	Chlorinator Viton O-ring
26482	O-2502	Chlorinator Viton O-ring
26784	O-2611	Chlorinator Viton O-ring
26822	O-2515	Chlorinator Viton O-ring
27409	O-2124	Chlorinator O-ring
27593	G-5051	Chlorinator Gasket
27594	G-5050	Chlorinator Gasket
30066	O-2512	Chlorinator Viton O-ring
30343	O-2507	Chlorinator Viton O-ring
31702	O-2508	Chlorinator Viton O-ring
31882	O-2510	Chlorinator Viton O-ring
33051	O-2520	Chlorinator Viton O-ring
34497	O-2110	Chlorinator O-ring (Not Viton)
34497	O-2520	Chlorinator Viton O-ring
37661	G-4225	Chlorinator Gasket
38437	O-2609	Chlorinator Viton O-ring
39648	O-2517	Chlorinator Viton O-ring
40040	O-2608	Chlorinator Viton O-ring
40336	G-4417	Chlorinator Gasket
41106	O-2521	Chlorinator Viton O-ring
44045	O-2607	Chlorinator Viton O-ring
44119	O-2520	Chlorinator Viton O-ring
44121	O-2210	Chlorinator O-ring
44122	G-4226	Chlorinator Gasket
45336	O-2616	Chlorinator Viton O-ring
46129	O-2256	Chlorinator O-ring
5745	O-2607	Chlorinator Viton O-ring
WATERCO		
621457	O-2264	Gray Valve Shaft O-ring
621462	O-2242	Gray Valve Sight Glass O-ring
63151	O-2167	Supatuf Pump H/L Pot O-ring
634016	MS-601	Pump Seal
6340241	O-2002	Supatuf Pump Union O-ring
635028	O-2214	Supatuf Pump Body O-ring
WATERMATIC		
1-020	G-4451	Rain Cover Gasket
1-110	G-4389	Hopper Lid Gasket
1-190	G-4602	Collar Gasket
1-370	G-4456	Diverter Bracket Gasket
WATERWAY		
—	G-3187	Large (Outside) Gasket For Jet on Medallion Pool
—	G-3188	Small (Inside) Gasket For Jet on Medallion Pool
—	O-2049	Quad Flo Jet O-ring
—	R-6155	48 Fram Pump Repair Kit
—	R-6156	75-125-200 Cyclone Pump Repair Kit
—	F-8326	Top Load Cartridge Filter O-ring Kit
568-0360	O-2095	Top Load Filter Lid O-ring
711-1290	G-4349	Bath Jet Gasket
711-1750	G-4364	Polyjet Standard Gasket
711-1760	G-4355	Bath Jet Gasket
711-1920	G-4609	Clearwater Sand Top Gasket
711-4000	G-4358	1 1/2" Union Gasket
711-4010	G-4359	2" Heater Tailpiece Gasket
711-4020	G-4627	2"-2 1/2" Union Gasket
711-4100	G-4053	Wide Mouth Gasket
711-4500	G-4356	Power Jet Gasket
711-4750	G-4354	Polyjet Gasket
711-5000	G-4347	Filter Niche Gasket
711-6020	G-4244	2 1/2" Heater Union Gasket

FITS OEM#	SSC#	DESCRIPTION
711-7000	G-4390	Spa Jet Body Gasket
711-9870	G-4376	Ozone/Cluster Jet Gasket
715-1001	O-2133	Air Relief O-ring
805-0014	O-2082	Hi-Flo Pump Drain Plug O-ring
805-0111	O-2024	Center Discharge Pump O-ring
805-0114	O-2133	Top Load Filter Air Bleeder O-ring
805-01205D	O-2053	Top Load Filter O-ring
805-0123	O-2263	Tailpiece Union O-ring
805-0132	O-2009	Polyjet O-ring
805-0140	O-2038	Power Jet O-ring
805-0145	O-2159	2" Heater Tailpiece O-ring
805-0145	O-2215	2" Union Connector O-ring
805-0224	O-2115	Heater Tailpiece 1 1/2" O-ring
805-0226	O-2195	1 1/2" Union Tailpiece O-ring
805-0226	O-2195	Union O-ring
805-0229	O-2226	2" Heater Tailpiece O-ring
805-0232	O-2280	2 1/2" Union O-ring
805-0252	O-2025	Bath Pump Volute O-ring
805-0254	O-2211	Top Mount Valve Lid O-ring
805-0256	O-2041	Bath Pump Volute O-ring
805-0261	O-2374	Executive 56 Pump Volute O-ring
805-0360	O-2095	Top Load Filter Lid O-ring
805-0383	O-2388	Clearwater DE, Cartridge Top O-ring
805-0436	O-2060	6" Trap Lid O-ring
805-237V	O-2525	Clearwater Feeder Viton Lid O-ring
806-0003	G-4632	Clearwater Feeder Gasket
806-1040	G-3029	Skim Filter Gasket
806-1070	G-3026	Square Skimfilter Gasket
811-1001AB	MS-1000	Pump Seal
WET INSTITUTE		
—	O-1039	Tank O-ring
—	O-2026	Seal Plate O-ring
—	O-2054	Pump Lid O-ring
32-050-715	O-1061	18" Tank O-ring for DE Filter
34-050-303	O-2247	Pump O-ring
34-050-309	G-3207	Trap to Volute Gasket
34-050-311	MS-1000	Pump Seal
34-050-312	O-2026	Bracket O-ring
WMC		
62100	O-2266	Hydron Sand Filter Neck O-ring
62133	O-2242	Hydro Sand Filter Sight Glass O-ring
621457	O-2264	Hydron Sand Filter Axle O-ring
621462	O-2242	Hydro Sand Filter Sight Glass O-ring
AT-1600-S	O-1226	Strainer Cover Gasket-AT
JS-1505R	O-2195	Union O-ring
JS-1571	O-2309	JS Pump Knob O-ring
JS-1701	O-2041	Pump Housing O-ring-Center Discharge
JS-1702	MS-200	Pump Seal
JS-1903	O-2095	Strainer Cover O-ring
JS-1904	O-2020	JS Pump Strainer O-ring
JS-3701	O-2025	JS Pump Housing O-ring-Side Discharge
SS-1600-R	O-2618	Diffuser Gasket-AT
SS-1600-T	O-1209	Housing Gasket-AT
SS-1600-Z-2	MS-201	Pump Seal

O-RINGS-LISTED IN SSC# ORDER

SSC#	FITS OEM	FITS OEM#	DESCRIPTION	SSC#	FITS OEM	FITS OEM#	DESCRIPTION
O-1001	Hayward	DEX2400-K	Micro Clear Vertical Fiberglass Tank O-ring		Wet Inst.	—	Tank O-ring
O-1002	Sta Rite	24700-73	24" DES-51 & 60 Tank O-ring	O-1040	Swimrite	—	50-57 Verticle Filter O-ring
O-1004	Sta Rite	24240-04	Cobra & Falcon Body O-ring	O-1041	Doughboy	308-1000	Tank O-ring
O-1006	Sta Rite	U9-175	Separation Tank O-ring		Doughboy	308-1056	Tank O-ring
O-1007	Sta Rite	24753-05	DEP-25 216, 108, 72 Cartridge O-ring-Fits 16"		Doughboy	MY220-RP	Pump Gasket
					Muskin	037-3434	16" Tank O-ring
O-1008	Miami	—	20" CF-104 Tank O-ring		Tank	—	16" Tank O-ring
	Sta Rite	U9-160	20" Tank O-ring	O-1042	American	550017	24" Tank O-ring
O-1009	Sta Rite	24751-05	24" DEP-51 Fiberglass Filter O-ring		Premier	25-745	24" Tank O-ring
					Sta Rite	U9-165	24" Tank O-ring
O-1010	Jacuzzi	13-0220-09	Flange O-ring		Swimrite	28-828-745	24" Satelite Tank O-ring
	Jacuzzi	47-0448-05	O-ring		Tank	—	24" Tank O-ring
	Sta Rite	35505-1365	O-ring	O-1043	Sta Rite	23382-13	Model X Filter O-ring
	Sta Rite	WC9-003	Cartridge Filter Tank O-ring	O-1044	Hayward	SX0240-Z-1	Sand Filter Tank O-ring
O-1011	Sta Rite	U9-200	PLBC Tank O-ring	O-1045	Pac Fab	—	O-ring
	Sta Rite	U9-389	PLBC Tank O-ring	O-1046	Sta Rite	24752-05	30" DEP-83 Fiberglass Filter O-ring
O-1012	Doughboy	308-1075	O-ring	O-1048	Pac Fab	17-4704	Mytilus/Turbo Tank O-ring
O-1013	Doughboy	308-1115	O-ring		Sta Rite	23568-15	Separation Tank O-ring
	Lomart	308-1115	O-ring	O-1049	Hayward	SX0160-Z-1	Sand Filter Tank O-ring
O-1014	American	—	Separation Tank O-ring	O-1050	Premier	25-311	6" Pump Lid O-ring
			MS6-72	O-1051	Lomart	053-014	13" Tank O-ring
	American	570032	12" Carbide Filter Tank O-ring	O-1052	Ampro	1403	14" Tank O-ring
	Anthony	04278	Separation Tank O-ring		Lomart	053-015	14" Tank O-ring
	Anthony	06483	Separation Tank 40/60 O-ring	O-1054	Hayward	CX0800-F	800 and 1100 Cartridge Filter O-ring
	Premier	27-678	Hercules II Tank O-ring	O-1055	Jacuzzi	13-0301-01	Tank Clasp O-ring
	Sta Rite	U9-191	Separation Tank O-ring		Miami	CF-52	16" Tank O-ring
	Swimrite	30-828-678	12" Separation Tank Cartridge Lid O-ring	O-1056	Pac Fab	15-2038	22" Tank O-ring
O-1015	Jacuzzi	47-0569-99	Earth Works Tank O-ring	O-1058	Lomart	053-074	16" Tank O-ring
	Sta Rite	24700-72	20" DES-36, HRS-20 Tank O-ring	O-1059	American	570073	Commander Tank O-ring
O-1016	Premier	31-713	7" Lid O-ring		Sta Rite	WC9-011	Cartridge Filter O-ring
	Swimrite	60-828-713	7" Stainless Steel Pump Lid O-ring-24.5" C/L	O-1060	American	—	Bottom Seal For Carbide 52/104 Sq. Ft.
O-1017	Ampro	3015-83	Tank O-ring		American	390022	Power Pump Body O-ring
O-1018	Swimrite	70-828-827	Large O-ring		American	570031	10" Sep. Tank O-ring
O-1019	Diaclear	C-46181	ES-7 Cover O-ring	O-1061	Wet Inst.	32-050-715	18" Tank O-ring for DE Filter
O-1020	Saurerman	—	Small Tank O-ring	O-1062	Pac Fab	15-2127	18" Tank O-ring
O-1021	Baker Hyd	00B7037	Tri-Filter Lid O-ring	O-1063	Landon	—	Separation Tank O-ring
O-1022	South Pac.	—	Old Style White Lid O-ring		Lomart	—	Separation Tank O-ring
O-1023	Coleco	33510	Fiberglass Tank O-ring		Purex	71441	CF-25, 50 & 700 Tank O-ring
O-1025	Anthony	12382	Ditron Tank O-ring		Purex	P-24275	Filter Lid O-ring
O-1026	Saurerman	—	Large Tank O-ring		Swimrite	38-828-680	10" Separation Tank O-ring
O-1027	South Pac.	—	New Style Brown Lid O-ring	O-1064	Lomart	053-110	11" Tank O-ring
O-1028	Starbright	—	SEP Tank O-ring	O-1065	Doughboy	308-1156	15" Tank O-ring
O-1029	Purex	71439	SM 4000 Tank O-ring		Lomart	053-213	Tank O-ring
O-1030	Hayward	—	Goldmarc Model 181 & 241 Cover O-ring	O-1066	Doughboy	308-1141	Filter Tank O-ring
O-1031	Pac Fab	—	9/16" X 67 1/2" Tank O-ring		Lomart	053-097	14" Tank O-ring
O-1032	Sta Rite	U9-105	11" Trap Lid O-ring		Tank	—	14" Tank O-ring
O-1033	Sta Rite	24700-74	Tank O-ring	O-1067	Purex	71433	C-18 Cover O-ring
O-1034	Muskin	54061	Tank Gasket	O-1069	Marine	7650-3	6 3/4" Clear Pump Lid O-ring
O-1035	Swimrite	60-828-713	7" Stainless Steel Pump Lid O-ring-21.25" C/L	O-1070	Pac Fab	31-3225	Mitra 11" Tank O-ring
O-1036	Sta Rite	U9-259	Sep. Tank O-ring	O-1071	Pac Fab	15-2235	16" PF-100 Tank O-ring
O-1037	Anthony	17434	A-40 O-ring	O-1073	Jacuzzi	47-0214-49	Earth Works Filter O-ring
	Pac Fab	19-5008	Old Style Tank Lid O-ring		Purex	71442	2000 Series Tank O-ring
	Starbright	—	20" Tank O-ring		Swimrite	28-828-687	18" Ventirite Tank O-ring
O-1038	Sta Rite	23383-15	X Model Tank O-ring	O-1074	Purex	71443	800 Series Tank O-ring
O-1039	American	530028	18" Tank O-ring	O-1076	Richardson	5099-135	22" Filter Tank O-ring
	Anthony	17433	18" Tank O-ring	O-1077	Marine	3760	Tank O-ring
	Marine	5260	Tank O-ring	O-1080	Marine	1600	Tank O-ring
	Muskin	037-3410	18" Tank O-ring	O-1082	American	390060	Ultra Flow Pump Volute O-ring
	Premier	23-671	18" Hercules Tank O-ring		Aqua Flo	92200180	O-ring
	Premier	27-671	18" Tank O-ring		Martec	320-110	Pool Master Housing O-ring
	Purex	71437	CF-100 Tank O-ring		Sta Rite	35505-0422	Seal Plate Housing O-ring
	Sta Rite	U9-145	18" Tank O-ring		Sta Rite	U9-228	Dura Glass Pump Clamp O-ring
	Swimrite	28-828-671	18" Filter Tank O-ring	O-1083	Premier	25-744	15" Atlas DE Filter Tank O-ring
	Universal	—	Filter Tank O-ring		Speck	2991300003	Badustar 913 Lid O-ring
				O-1084	Sta Rite	24700-69	Tank O-ring

O-RINGS-LISTED IN SSC# ORDER

SSC#	FITS OEM	FITS OEM#	DESCRIPTION	SSC#	FITS OEM	FITS OEM#	DESCRIPTION
O-1085	Pac Fab Superflow	15-2038-3	Tank O-ring	O-1149	Muskin	72032	14" Metal Tank O-ring
O-1087	Pac Fab Superflow	15-2038-2	Tank O-ring	O-1150	Sundance	6560-043	Hi Flo Heater O-ring
O-1090	Doughboy Lomart	308-1142	20" Tank O-ring	O-1151	Sta Rite	24750-0006	HRPB O-ring
O-1091	Marine Starbright	053-174	Tank O-ring	O-1152	Richardson	5099-125	18" Tank O-ring
O-1093	Swimrite Purex	64-828-946	10" Series II Gasket	O-1153	Richardson	4546-001	Cartridge O-ring
O-1095	Hayward Universal	GMX0600-FST	Threaded Filter/Valve Lid O-ring	O-1154	Purex	73270	Filter Tank O-ring
O-1099	Hayward	DEX0360-K	Micro Clear DE Vertical S/S Filter Tank O-ring	O-1155	Sta Rite	24751-0006	HRPB O-ring
O-1100	Pac Fab	19-5310	Filter Tank O-ring	O-1156	Sta Rite	24752-0006	HRPB O-ring
O-1101	Jacuzzi	42-2927-06	Dial Valve & Sandtrap Filter Adapter Valve O-ring	O-1157	Sta Rite	27001-0060S	System 3 Cord O-ring (Pre-3/97)
O-1102	Muskin Tank	54066	15" Tank Lid O-ring	O-1158	Anthony	6527	Separation Tank O-ring
O-1106	Muskin Sta Rite	037-3430	20" Tank O-ring	O-1159	Hayward	SX0200-Z-7	S-200 Filter Tank O-ring
O-1110	Tank	—	19" Tank O-ring	O-1160	Jandy	R0350600	C Series Cartridge Filter Tank O-ring
O-1114	American	550015	Sandpiper Tank O-ring (Before 11-94)	O-1161	Jandy	R0357800	CL Series Cartridge Filter Tank O-ring
O-1115	Tank	—	17" Tank O-ring	O-1205	American	191016	O-ring
O-1116	Jacuzzi	13-0417-02	Cartridge Filter Cover O-ring	O-1207	American	791016	Gasket/O-ring Before 1986
O-1117	Sta Rite	23383-13	SilverSeal, Capri Tank O-ring	O-1209	Harmsco	550	11" Rim Gasket/O-ring BF-84, 126 Large
O-1118	Sta Rite	24700-71	Tank O-ring	O-1209	Baker Hyd	35B1108	Spa Pak Pump Housing Gasket/O-ring
O-1119	Lomart Richardson	053-131	Tank O-ring	O-1210	Gulf	352506230	Power Tech Pump Gasket
O-1120	Dynapure	D-T1	18" Sand Filter O-ring	O-1210	Hayward	SPX1600-T	Super Pump Gasket
O-1121	International	6291-9	18" Tank O-ring	O-1210	WMC	SS-1600-T	Housing Gasket-AT
O-1122	International	6721-9	Tank O-ring	O-1210	Baker Hyd	00B7000	Control Plate Gasket/O-ring
O-1123	Jacuzzi	13-0428-09	SS-24 Filter Tank O-ring	O-1210	Purex	70247	Control Plate Gasket/O-ring
O-1124	Lomart	053-146	24" Tank O-ring	O-1211	American	791085	Spa Light Lens Gasket/O-ring
O-1125	Jacuzzi	13-0221-08	Flange O-ring	O-1212	American	791016N	Light Lens Gasket/O-ring-After 1986
O-1126	Miami	—	FG18 & FG24 Lid O-ring	O-1215	Hayward	CX0250-F	250, 500 & 750 Tank O-ring
O-1127	Landon	—	Stainless Steel Tank O-ring	O-1216	Anthony	14118	Double Bead Light Lens Gasket
O-1128	Monarch	197989	D7 O-ring	O-1217	Universal	—	Lens Gasket
O-1129	Lomart	053-210	O-ring	O-1217	Hayward	SPX3000-T	Super II Pump Housing Gasket.O-ring
O-1130	Swimrite	28-828-686	Ventirite Series Tank O-ring	O-1225	Leslies	SPX3000-T	Hydramax II Housing Gasket
O-1131	Marine	624-5	Sand Filter Tank O-ring	O-1225	Paddock	—	Clamp Type & Combination O-ring
O-1132	Swimrite	28-828-689	Marathon Filter O-ring	O-1226	Swimline	14118	Gasket
O-1133	Sta Rite	24700-68	16" DES-25, HRS-16 Tank O-ring	O-1226	Universal	—	Lens Gasket
O-1134	Doughboy	308-1113	Sand, DE & Silica I Tank O-ring	O-1226	Gulf	352506260	Power Tech Cover Gasket
O-1135	Doughboy	308-1114	Silica II Tank O-ring	O-1227	Hayward	SPX1600-S	Super Pump Lid Gasket
O-1137	Ampro	3015-82	Cent. 2000 Cover O-ring	O-1227	WMC	AT-1600-S	Strainer Cover Gasket-AT
O-1138	Richardson	—	22" Tank O-ring	O-1227	Sta Rite	WC20-03	6.5" Separation Tank Gasket
O-1139	Richardson	—	Cartridge O-ring	O-2001	American	791169	Aqua Luminator O-ring
O-1140	Speck	2991300004	Badustar 913 Cartridge O-ring	O-2001	Ampro	900-9S	Large Spool O-ring
O-1141	American	390102	RPM Tank Cover O-ring	O-2001	Polaris	9-100-5140	Filter Housing O-ring
O-1142	American	590210	CM Tank Cover O-ring	O-2001	Sta Rite	U9-309	Plunger O-ring
O-1143	American	530088	Quantum Tank O-ring (After 11-94)	O-2002	Advance	OV-11-332	Chlorinator O-ring
O-1144	Hayward	RGX0045-G	Regenex Filter Head O-ring	O-2002	Caretaker	413-0640	Union Assembly O-ring
O-1145	Astral	722R1100110	Light O-ring	O-2002	Caretaker	6340241	Hydrostorm Union O-ring
O-1146	Muskin	72031	15" Metal Tank O-ring	O-2002	Harmsco	930	Holding Rod O-ring For BF96/ BF144 Cartridge Filter
O-1147	Muskin	54068	11" Tank O-ring	O-2002	Jandy	R0339600	Coupling Set O-ring (For Kit Order 2)
O-1148	Muskin	54069	18" Resin Tank O-ring	O-2003	Landon	—	2" Spin Collection O-ring
				O-2003	Lomart	—	Spin 2" Coll. O-ring
				O-2003	Pac Fab	27-4494	Valve Adapter O-ring
				O-2003	Richardson	5099-529	2" Sand Valve Adapter O-ring
				O-2003	Sta Rite	—	PMKGFV 15-20-25-33 Collection O-ring
				O-2003	Sta Rite	35505-1424	System 3 O-ring
				O-2003	Sta Rite	U9-156	2" Return Hub O-ring
				O-2003	Sta Rite	U9-374	Diffuser O-ring
				O-2003	Swimrite	—	Lid O-ring
				O-2003	Waterco	6340241	Supatuf Pump Union O-ring
				O-2003	Fischer	101W814U01	Chlorinator O-ring
				O-2003	Jandy	2300	Porpoise Hydrotimer Case O-r
				O-2003	Letro	F-31	Hose Assembly O-ring

O-RINGS-LISTED IN SSC# ORDER

SSC#	FITS OEM	FITS OEM#	DESCRIPTION	SSC#	FITS OEM	FITS OEM#	DESCRIPTION
O-2004	Anthony	17791	Brass Push Pull Valve 1.5 O-ring	O-2022	Hayward	SPXST0269Z5B	Hair and Lint Strainer O-ring-304, 340R
	Hayward	SFX0400-Z-1	Large Drain Valve O-ring		Sta Rite	35505-1281	Skimmer O-ring
	Polaris	6-505-00	O-ring UWF/QD	O-2023	Hayward	SPX1450-M	Turbo Boost Winter/Test Plug O-ring
	Sta Rite	35505-1401	Index Plate & Piston O-ring-Plastic Pucks		Tesco	H-301	Widget Upper Case O-ring
O-2005	Regal	S-408	Chlorinator O-ring	O-2024	Acura	1058	Magna Drain Plug O-ring
	Vico	PPWWVO/R	Volute O-ring		American	—	Separation Tank Air Relief Valve O-ring
O-2006	Anthony	17438	Spinfilter End Bell O-ring		American	510031	Stem & Shaft Cap O-ring
	Hydro Air	—	ADI Flowjet O-ring		Anthony	17437	Valve Shaft O-ring
	Jacuzzi	—	Collection O-ring		Doughboy	308-1009	Air Relief Fitting O-ring
	King	945	King Feeder Control Dial O-ring Kit		E-Z Chlor	12690-09	Flow Meter Gasket
	Premier	29-225	Return Spin Filter O-ring		Jacuzzi	20-1010-00	RTC Pump O-ring
	Saureman	—	Manifold O-ring		Jacuzzi	47-0112-00	Stem & Crank O-ring
	Spin Rite	—	Collection Tube O-ring		Jacuzzi	47-0112-99	Plug O-ring
	Swimrite	28-828-678	Spin Filter Manifold O-ring		K-D Pools	47-0112-00	Sand Filter O-ring
O-2007	Doughboy	308-1125	Cyclops Strainer Cover O-ring		Letro	LL-14	Gear Assembly O-ring
	Hayward	SPX1500-P	Power Flow Pump Lid O-ring		Letro	P-40	Hose Assembly O-ring
	Jacuzzi	47-0354-07	U Series Pump O-ring		Marine	—	Valve Stem O-ring
	Lomart	053-159	Strainer O-ring		Martec	201-010	Drain Plug O-ring
	Sta Rite	35505-7430	O-ring		Martec	205-104	Bleeder O-ring
O-2008	American	—	1 1/2" Collection O-ring		Pac Fab	—	Crankshaft O-ring
	Anthony	—	Piston O-ring		Pac Fab	02-112	Crankshaft O-ring
	Hayward	SPX0410-Z-1	SP410X Piston O-ring-Small		Pac Fab	27-3011	Brass Valve Shaft O-ring
	Laars	S-690	Heater O-ring		Polaris	E-45	Backup Valve Plate O-ring
	Landon	—	Spin 1 1/2" Collection O-ring		Polaris	P-40	Pump Shaft O-ring
	Paddock	—	Petite Spin Filter Tube O-ring		Premier	—	Crank O-ring
	Sta Rite	U9-154	1 1/2" Return Filter O-ring		Premier	29-113	Series 220 Shaft Extension & Crank O-ring
O-2009	Danner	—	Model 350 Cover Pump O-ring		Purex	72555	Ortega Valve Stem O-ring
	Jacuzzi	47-0131-07	Gyro Flo O-ring		Raypak	—	Manual By-Pass O-ring
	Jacuzzi	47-0331-05	O-ring		Speck	2923541220	Pump Housing O-ring
	Premier	31-157	300 Series Swivel O-ring		Spin Rite	—	Crank O-ring
	Saureman	—	1 1/2" Tube O-ring		Sta Rite	U9-147	Bronze Cap Valve O-ring
	Sta Rite	35505-1175	Valve Connector O-ring		Sta Rite	U9-359	Posi Flo II Air Release O-ring
	Sta Rite	U9-245	Plunger Top O-ring		Swimrite	28-828-675	Spin Crank O-ring
	Waterway	805-0132	Polyjet O-ring		Swimrite	30-828-750	1 1/2" x 1 1/2 Shaft O-ring
O-2010	Speck	2920741270	Model 423 Tank O-ring		Swimrite	30-828-756	1 1/2" V Crank Pump O-ring
	Sta Rite	—	Unitrol Valve Piston O-ring		Universal	—	Stem & Crank O-ring
	Sta Rite	35505-1318	Piston Plastic Slide Valve-2"		Vico	PPULPLUGOR	Ultrajet Pump Plug O-ring
O-2011	Arneson	W-430	Leaf Cannister O-ring		Waterway	805-0111	Center Discharge Pump O-ring
	Astral	7731520035	Astra Max O-ring	O-2025	American	510022	1 1/2" O-ring
	Poolsweep	W-430	Leaf Cannister O-ring		Aqua Flo	92200200	Flo Master, Tubmaster Volute O-ring
	Tesco	H-301	Widget Lower Case O-ring		Astral	711R1329035	Chemical Feeder O-ring
O-2012	American	371017	Lid O-ring		Astral	7731329035	Astra Max O-ring
	American	391017	Americana II Lid O-ring		Baker Hyd	30C3005	1 1/2" Multiport Valve Cover O-ring
O-2015	Jacuzzi	47-0233-04	H4 Booster O-ring		Hayward	SPX0710-Z-3	Valve Lid O-ring (Prior to 1976)
	Pac Fab	35-5331	Challenger Diffuser O-ring		Hayward	SPXST0266Z5B	Hair and Lint Strainer O-ring-320, 325, 320R, 325R
O-2017	American	501415	1 1/2" Multiport Valve T/M Series Lid O-ring		Leslies	SPX0710-Z-3	Hydramax A/G O-ring
	Doughboy	308-1005	3/4 HP Pump O-ring		Martec	300-004	Wet End O-ring
O-2018	Anthony	LL	Lens O-ring		Pac Fab	27-1103	Valve Cover O-ring
	Kim	—	Lens O-ring		Sta Rite	—	PDC Bottom O-ring
O-2019	Sta Rite	35505-1007	Hydro Valet Face Plate Inlet O-ring		Sta Rite	35505-1408	XL-VII Pump Volute O-ring
O-2020	American	—	Americana Spacemaker Collector O-ring		Waterway	805-0252	Bath Pump Volute O-ring
	Baker Hyd	301560	Old Spa Pak Pump Gasket		WMC	JS-3701	JS Pump Housing O-ring-Side Discharge
	Hayward	SPX1491-B	Econo Union O-ring	O-2026	American	397018	Pump O-ring
	Hercules	760502	Heater Element O-ring		American	397028	6 3/4" Bronze Pump O-ring
	Hyprime	—	Small Impeller O-ring		Premier	31-159	Volute O-ring
	Jacuzzi	47-0129-01	Skimmer Mat O-ring		Vico	PPUFVOR	Ultrajet O-ring
	Jacuzzi	47-0221-08	4 Way Valve Disc Body O-ring		Wet Inst.	—	Seal Plate O-ring
	Jacuzzi	47-0222-07	PM Filter Valve O-ring		Wet Inst.	34-050-312	Bracket O-ring
	Lomart	053-026	Strainer O-ring	O-2028	Pac Fab	—	5" H & L Trap O-ring
	Marlow	—	Diffuser 1/3-1 HP Mardur Pump O-ring		Pac Fab	35-2602	New Style 5" H & L Trap O-r
	Muskin	54072	Filter O-ring				
	WMC	JS-1904	JS Pump Strainer O-ring				

O-RINGS-LISTED IN SSC# ORDER

SSC#	FITS OEM	FITS OEM#	DESCRIPTION	SSC#	FITS OEM	FITS OEM#	DESCRIPTION
	Pac Fab	35-2604	590 Glass Pump Lid O-ring	O-2046	Pac Fab	35-5329	Old Style Challenger Housing O-ring
O-2029	Swimrite	60-828-486	5" Clear Lid Gasket		Sta Rite	31935-0001	Posi Flo II Lid O-ring
O-2030	Swimrite	28-828-668	Ret. End Bell O-ring	O-2047	Sta Rite	U9-301	Posi Flo Top O-ring
	American	570113	Commander II In-Line Cartridge Filter Drain O-ring	O-2049	Hayward	SPX1070-Z-2	Float Valve O-ring
	Purex	72553	Ortega 1 1/2" Cover Seal		Jacuzzi	47-0143-03	2" Multiport Valve O-ring (After 8/73)
O-2032	Sta Rite	U9-239	Pump O-ring		Jandy	6749	Valve O-ring
	Aqua Flo	92200020	8" Trap Cover O-ring-AC		King	106-000-016	King Tech New Style Cap O-ring
	Astral	721R180060	Persius Sand Filter O-ring		King	122	King Feeder Cap O-ring
	Pac Fab	—	8" Trap Lid O-ring	O-2051	Waterway	—	Quad Flo Jet O-ring
O-2034	Premier	39-441	8" Trap Lid O-ring		Blue White	9003-058	Chlorinator O-ring
	Jacuzzi	47-0268-02	PM Filter Top O-ring		Hydro Air	—	Air Control O-ring
	Purex	71448	Valve Body O-ring		Lomart	053-075	Tube O-ring
O-2038	Doughboy	308-1134	Pro X Backwash Valve Cap O-ring		Regal	S-413	Chlorinator O-ring
	Lomart	053-044	Back Wash Cap O-ring, Pro Pump Diffuser O-ring	O-2053	American	469250	Mini Air Control O-ring
	Swimrite	28-828-021	O-ring		Hydro Air	10-3953	Jet Assemblies O-ring
O-2040	Waterway	805-0140	Power Jet O-ring		Martec	410-504	O-ring
	American	391029	Titan O-ring, Sandpiper O-ring (Current Version)	O-2054	Waterway	805-01205D	Top Load Filter O-ring
	Baker Hyd	00B7027	Old Style Bulkhead Adapter O-ring		American	393003	Pump Lid O-ring
	Coleco	33185	Cover O-ring		American	393006	Locking Ring Lid O-ring
	Hayward	SPX1495-Z-1	Ball Valve Flush Union O-ring		American	510116	Eclipse Valve O-ring
	Hyprime	—	Large Impeller O-ring		American	520005	Eclipse O-ring
	Jacuzzi	47-0227-02	Gyro-Flo O-ring	O-2056	Jacuzzi	47-0439-06	Cast Iron PJM Lid O-ring
	Jacuzzi	47-0227-36	Gyromat B/W Lower Valve O-ring		Swimrite	60-828-487	7" Clear Lid Gasket
	Marlow	43117	Argonaut Diffuser O-ring	O-2056	Wet Inst.	—	Pump Lid O-ring
	Monarch	—	Old Time Impeller O-ring		Hayward	SX0220-Z-2	Bulkhead Fitting O-ring
	Pac Fab	27-3062	2" PVC Valve Cap O-ring	O-2058	Speck	2991300002	Badustar 913 Diff. O-ring
	Purex	70213	Old Style Bulkhead Union O-ring-00B7027		Hayward	GMX0600-F	Filter Tank Lid O-ring
	Purex	72559	1 1/2" Ortega Valve Cap O-ring		Jacuzzi	47-0364-05	Dial Valve O-ring
	Raypak	—	U-G #H O-ring		Jacuzzi	47-0364-47	Magnum Pump Housing O-ring
	Raypak	—	Solar Valve Body Union O-ring	O-2059	Premier	25-313	8" Sidewinder O-ring
	Sta Rite	35505-1428	Elbow Assembly O-ring		Richardson	5535-101	Sand Filter O-ring
O-2041	Acura	1059	Aquaheat Large Pump O-ring		Jacuzzi	47-0352-41	Lid O-ring
	Aqua Flo	FCF-11	O-ring		K-D Pools	47-0352-41	LR6 Strainer Cover O-ring
	Doughboy	308-1038	O-ring		Pac Fab	27-2708	Filter Top O-ring/Valve Body O-ring
	Doughboy	308-1099	PPI Diffuser O-ring	O-2060	Speck	2020341210	O-ring
	Gulf	352507091	Power Tech 2 Housing O-ring		American	392041	Eagle Pump Lid O-ring, Filter O-ring
	Jacuzzi	47-0256-06	PM Filter Valve O-ring		Pac Fab	35-0013	Challenger High Pressure Pump Lid O-ring
	Martec	201-004	Filter Body O-ring		Premier	P-136P	New Style Clear Lid O-ring
	Pac Fab	15-4493	Filter Dome Lid O-ring		Sta Rite	U9-229	Dura Glass Pump Lid O-ring
	Pac Fab	15-4495	Triton II Closure O-ring	O-2066	Waterway	805-0436	6" Trap Lid O-ring
	Premier	31-256	O-ring		American	391016	Americana II Body O-ring
	Purex	71422	Aquatron Lid O-ring		International	—	Manifold O-ring
	Rainbow	18608	Leaf Trap O-ring	O-2067	Pac Fab	19-1517	Star 50 DE Standpipe O-ring
	Rainbow	21-1236	180 Leaf Trap Lid O-ring		American	510183	2" Multiport Valve Threaded O-ring
	Rainbow	21-1366	In Line Leaf Trap Lid O-ring		Ampro	200-36	Lexan Pump Body O-ring
	Sta Rite	—	Delrin and Sand O-ring		Aqua Flo	92200050	C Series Volute O-ring
	Sta Rite	—	Sand Filter Cover O-ring		Aqua Flo	CF-11	C Series Volute O-ring, Dominator O-ring
	Sta Rite	35505-1272	O-ring		Hayward	SPX0715-Z-1	Multiport Valve Cover O-ring
	Sta Rite	35505-1273	Float Valve O-ring		Purex	71447	PA Series Pump O-ring
	Sta Rite	35505-1409	Skimmer Lid O-ring	O-2068	Sta Rite	U9-243	Cover O-ring
	Swimrite	70-828-828	Small O-ring		Advance	OV-11-325	Chlorinator O-ring
	Waterway	805-0256	Bath Pump Volute O-ring		American	510050	2" B/W Valve Piston O-ring
	WMC	JS-1701	Pump Housing O-ring-Center Discharge		Marine	5280	Bearing & Manifold O-ring
O-2042	Ampro	—	Large O-ring for Spool 900-8S, 900-7S		Pac Fab	15-2122	O-ring
	Sta Rite	35505-1263	1 1/2" Piston O-ring-Brass Pucks-Old Style		Pac Fab	27-3090	2" Slide Valve O-ring
	Sta Rite	35505-1401	Index Plate & Piston O-ring-Brass Pucks	O-2071	Premier	—	2" Backwash Valve Valve O-ring
O-2044	Purex	72554	Ortega 2" Cover Seal O-ring		Pac Fab	19-1424	Star 40/ Mytilus Bottom Piping O-ring
	Sta Rite	U9-240	Pump O-ring		Speck	2920141210	Casing O-ring, 410 Lid O-ring, Etc.

O-RINGS-LISTED IN SSC# ORDER

SSC#	FITS OEM	FITS OEM#	DESCRIPTION	SSC#	FITS OEM	FITS OEM#	DESCRIPTION
O-2079	American	391015	Body O-ring		Pac Fab	27-5333	Valve Body O-ring TA100D
	Homelite	62772	O-ring		Speck	2920141220	410 Casing O-ring
	Hydro	PO-0050	Dynamic Pump Volute O-ring		Speck	2991300001	913 Casing O-ring
	Purex	71418	JT Adapter O-ring	O-2092	Ampro	900	Small Spool O-ring for 900-7S, 8S
O-2080	American	390004	Power Pump Lid O-ring		Sta Rite	35505-1423	System 3 Sand Adapter O-ring
	Jacuzzi	—	U25B Lid O-ring		Anthony	—	1 1/2" Old Style Piston Ring
	Jacuzzi	47-0434-01	Magnum Pump Lid O-ring Prior to 7/89	O-2093	Baracuda	67600	Zippy/Zippy Pure Wall Adapter O-ring
	Pac Fab	35-2600	Old Style 700 Lid O-ring, Hydro O-ring		Blue Haven	—	1 1/2" Old Style Piston Ring
	Pac Fab	35-3525	New Style Porpoise Clear Lid O-ring	O-2094	Astral	721R1820060	Valve Body O-ring
	Pac Fab	35-5332	New Style Challenger Pump Lid O-ring		Baker Hyd	15B3315	Tank O-ring-16, 20, 24
O-2082	American	—	Crank O-ring		Jacuzzi	47-0442-01	H&L Strainer O-ring
	American	390100	Impeller O-ring		Jacuzzi	47-0464-04	2" DV Cover O-ring
	American	470642	Titan Lid Fitting O-ring		Marlow	44802	Argonaut Bracket O-ring
	American	477210	Cyclojet Small O-ring		Sta Rite	35505-7432S	Pool Heater Manifold O-ring
	Aqua Flo	92200070	O-ring	O-2095	Sta Rite	U9-369	V/F Tank Flange O-ring
	Arneson	F-07	PoolswEEP O-ring		American	392003	Plate to Volute O-ring
	Baker Hyd	31B0035	Index Plate O-ring		Baker Hyd	17B1087	25 Sq. Ft. Lid O-ring
	E-Z Chlor	168092	Top Flowmeter O-ring		Hayward	CX0120-D	Cartridge Filter Lid O-ring
	E-Z Chlor	824092	Top Flowmeter O-ring		Jacuzzi	47-0360-09	CFT 25 Filter O-ring
	Landon	—	Crank Shaft O-ring		Lomart	053-200	Pro Pump Cover O-ring
	Letro	LF-07	O-ring		Rainbow	17-2223	25 Sq. Ft. Filter Lid O-ring
	Lomart	—	Crankshaft O-ring		Sta Rite	16920-12	XL-VII Pump O-ring
	Pac Fab	19-2115	RM Spin Filter Crank O-ring		Waterway	568-0360	Top Load Filter Lid O-ring
	Purex	70156	O-ring		Waterway	805-0360	Top Load Filter Lid O-ring
	Rainbow	17-2393	DSF Skimmer Access Plug O-ring	O-2096	WMC	JS-1903	Strainer Cover O-ring
	Sta Rite	—	31B0035 Index Plate O-ring		Hayward	SPX1434-J	Vari Flo Nozzle O-ring
	Sta Rite	—	Index Plate Small O-ring	O-2098	Sta Rite	35505-1121	Dial Valve O-ring
	Sta Rite	—	31B0035 Index Plate O-ring		Hayward	SPX1438-H	Pro Jet O-ring
	Sta Rite	35505-1116	Piston Assembly O-ring	O-2099	Polaris	9-100-5132	Timer O-ring
	Waterway	805-0014	Hi-Flo Pump Drain Plug O-ring		Anthony	HL4	4" H&L Trap O-ring
O-2086	Brett	60-0001	EM103 Heater & Pump O-ring		Diaclear	C-30082-MS	Strainer Cover O-ring
	Hydro Quip	60-0001	Heater Element O-ring		Premier	31-346	4" Pump Lid O-ring
	Hydropump	HL4	4" H&L Trap O-ring		Sta Rite	U9-045	4" Pump Lid O-ring
	Jacuzzi	47-0349-06	PJM Cap O-ring	O-2100	Sta Rite	U9-295	Pump Cover O-ring
	Muskin	54064	Strainer Pump Lid O-ring		Anthony	—	Rear Seal O-ring
	Purex	71420	O-ring for Soltron		Caretaker	634011	Hydrostorm Pump Diffuser O-ring
	Sta Rite	27001-0061S	Filter O-ring		Dura	—	Union Ball Valve O-ring
	Sta Rite	35505-1437	ABG Pump Trap Lid O-ring		Jandy	R0338801	Diffuser O-ring
	Vita	—	Heater Housing O-ring		Kim	—	Rear Seal O-ring
O-2087	Anthony	11027	Conv. Kit O-ring		Marlow	—	H Series 2 HP Diffuser O-ring
O-2088	King	01-22-1926	Cap O-ring		Marlow	21035	AF Diffuser O-ring-3 HP
	Sta Rite	16503-07	Body O-ring		Marlow	25475	H Diffuser O-ring-2 HP
	Sta Rite	35505-1266	XLIII Pump Seal Plate O-ring		Pac Fab	15-4491	1 1/2" Bulkhead O-ring
O-2089	Baker Hyd	00B7026	Newport Sand Filter Valve Tank O-ring		Plastiline	—	1 1/2" Union O-ring
	Jacuzzi	47-0262-08	O-ring	O-2101	Sta Rite	35505-1317	Fill Cap & MF23 Tube O-ring
	Letro	LA-415	Booster Pump O-ring		Gould	—	Old Style Turbo Valve O-ring
	Lomart	308-1078	Spectra II, Ultima II Valve to Tank O-ring	O-2102	Jacuzzi	47-0115-07	S/W Injector O-ring
O-2090	American	467130	Diverta Port Valve Bobbin O-ring		Laars	—	Control Well O-ring
	American	570065	Commander Gauge Plug O-ring, Maxim Pump O-ring		Pac Fab	—	Crankshaft O-ring
	Doughboy	308-1001	Manifold Seal O-ring		Pac Fab	15-4287	Valve Shaft O-ring
	Hayward	ECX1321-A	Micro Star Air Relief Valve O-ring		Raypak	—	Control Well O-ring
	Hayward	SPX1082-Z410	Star Clear Relief Valve O-ring	O-2103	Sta Rite	35505-1157	Knob O-ring
	Jacuzzi	47-0110-02	Valve & Filter O-ring		Fischer	101W816U01	Chlorinator O-ring
	Pac Fab	27-3060	2" PVC Valve Shaft O-ring	O-2104	Purex	71444	Whisperflo Diffuser O-ring
	Purex	71436	Sel. Valve Shaft O-ring		Aqua Flo	FF-14-02	Seal Cup O-ring
	Sta Rite	35505-1152	Dial Valve Shaft O-ring		Doughboy	308-1003	Manifold Bearing O-ring
	Sta Rite	U9-221	WC-212-7 Valve Cap O-ring		Doughboy	308-1040	Insulator O-ring
	Swimrite	30-828-670	Valve Stem O-ring		Hayward	SPX1500-M	SF400 Small Drain Valve O-ring
O-2091	Hayward	SX0200-Z-6	Sand Filter Lid O-ring		Muskin	54063	Spider O-ring
	Nature 2	2-13061	Cap O-ring	O-2105	American	472264	Diverter Jet Valve O-ring
					Hayward	ECX1287	DE Filter Gauge O-ring
				O-2106	American	—	Titan Manifold O-ring
					American	510035	Sand Filter Union O-ring
					American	510135	ABS Valve Body O-ring
					American	590006	Manifold O-ring

O-RINGS-LISTED IN SSC# ORDER

SSC#	FITS OEM	FITS OEM#	DESCRIPTION	SSC#	FITS OEM	FITS OEM#	DESCRIPTION	
	Anthony	—	Bulkhead Connector	O-2121	Ampro	600-57	H&L Pot Lid O-ring	
	Anthony	17790	2" Plastic Valve Union O-ring		Anthony	—	Hydro H&L Lid O-ring	
	Baker Hyd	—	Valve Coupler O-ring		Hydropump	—	5" H & L Trap O-ring	
	Baker Hyd	00B7001	Bulkhead Fitting O-ring		Lomart	053-058	Strainer Cover O-ring	
	Hayward	DEX2400-Z-5	Outlet Elbow O-ring		Marine	—	5" Clear Plastic H&L Lid O-ring	
	Jacuzzi	47-0139-09	TP4 Test Plug O-ring		Pac Fab	35-4052	540 Pump Lid O-ring	
	Pac Fab	—	PVC Backwash Valve Cap O-ring		Sta Rite	35505-1338	XLVI Pump Lid O-ring	
	Pac Fab	—	Mark Series Center Pipe O-ring	O-2122	Swimrite	—	H&L Lid O-ring	
	Pac Fab	—	RPZ Pot to Volute O-ring		Aladdin	O-408	Vac Master Lid O-ring	
	Pac Fab	—	Nautilus Manifold O-ring		Doughboy	308-1064	O-ring	
	Pac Fab	19-2300	Mytilus Connector & Bulkhead O-ring		Hayward	GMX0142-C-8	O-ring	
	Pac Fab	19-2323	Filter & Pump Gasket		Hayward	SPX1070-Z-1	Float Valve O-ring	
	Purex	—	CHD O-ring	O-2124	Premier	—	550 Noryl Bracket O-ring	
	Purex	70238	OOB7001 Bulkhead O-ring		Advance	OV-11-113	Chlorinator O-ring	
	Purex	P-24305	Center Tube O-ring		American	—	Multiport Valve Rotor Shaft O-ring	
	Saureman	—	2" Tube O-ring		E-Z Chlor	—	Flow Meter O-ring	
	Sta Rite	—	Dep. 83 Valve Adapter O-ring		Fischer	101W711U01	Chlorinator O-ring	
O-2107	South Pac.	—	Old Style Brown Lid O-ring		Hayward	ECX2899-A	Perflex Pump Shaft O-ring, Small O-ring	
	Sta Rite	U9-171	8" Trap Lid O-ring		Hayward	SPX0722-H	Stem O-ring (Prior to 1975)	
O-2109	Berkely	—	5" H&L Pot Lid O-ring		Internationl	—	Crank O-ring	
O-2110	Sta Rite	U9-244	O-ring		Jandy	—	Leaf Trap O-ring	
	Tesco	F-35	Pure Water Feeder Lid O-ring		Letro	JV-18	Jet Vac O-ring	
	Wallace	34497	Chlorinator O-ring (Not Viton)		Letro	LLC140	Thrust Jet O-ring	
O-2111	American	390066	Ultra Flow Pump Volute O-ring		Pac Fab	27-2406	2" Hi-Flow Valve Shaft O-ring	
	Sta Rite	35505-1245	Turbo Clean Head O-ring		Polaris	C-140	Thrust Jet O-ring	
	Sta Rite	U9-362	Valve O-ring-WC212		Pool Tender	05-009-1005	O-ring for All Models	
	Tesco	—	M/A Feeder Cap O-ring		Premier	—	Shaft Extension O-ring	
O-2112	Fiberstars	A9981	Small O-ring		Premier	—	Spin Filter Crank O-ring	
	Marlow	—	Diffuser O-ring		Purex	71435	Noryl Rotor Shaft O-ring	
	Rainbow	17-2319	320 Chlorinator Base O-ring		Raypak	800031	Bypass Manual O-ring	
O-2114	Astral	773R0950050	Sand Filter O-ring		Regal	S-404	Chlorinator O-ring	
	Coleco	33235	Cover O-ring		Regal	S-410	Chlorinator O-ring	
	Pac Fab	15-4005	C-3 O-ring		Swimrite	—	Shaft O-ring	
	Rainbow	17-2009	Cartridge Filter Lid O-ring		Wallace	27409	Chlorinator O-ring	
	Sta Rite	35505-1332	O-ring	O-2125	Acura	0430	Power Quip Heater O-ring	
	Sta Rite	35505-1425	System 3 O-ring		Jandy	2614	Energy Filter Bowl O-ring	
O-2115	Amer Gran	50-1100BSS	1 1/2" Heat Sink O-ring		Jandy	3293	Sheer Descent Cover O-ring	
	American	510034	Bronze Valve Cap O-ring		Johns Man	—	Johns Manville & Amitek O-ring	
	Doughboy	308-1016	Outlet Retainer O-ring		O-2126	American	510032	Valve Stem O-ring
	Hayward	SPX1022-C	Seal Plug O-ring		Premier	21-500	1 1/2" Piston Seal O-ring	
	Jacuzzi	—	4 Way Valve Upper O-ring		Premier	P-7515	1 1/2" Backwash Valve O-ring	
	Jacuzzi	47-0224-05	PM Filter Valve O-ring		Swimrite	30-828-752	1 1/2" Piston O-ring	
	Landon	—	Backwash O-ring		Swimrite	30-828-757	1 1/2" Piston O-ring	
	Lomart	—	Backwash Valve O-ring		Universal	—	Valve Piston O-ring	
	Marine	—	Valve Cap O-ring	O-2127	Lomart	053-101	O-ring	
	Martec	700-408	1 1/2" O-ring for Tail	O-2128	Aqua Flo	92200190	Dominator Trap Lid O-ring	
	Pac Fab	19-1474	Star DE Filter O-ring		Astral	722R1362035	Top Mount M/V Lid O-ring	
	Premier	—	1 1/2" Valve Cap O-ring		Astral	722R1362035	Multiport Valve Lid O-ring	
	Swimrite	28-828-667	Return Hub O-ring		Hayward	SPX0704-F	1 1/2" Vari-Flo Cover O-ring	
	Swimrite	28-828-679	Return O-ring		Hayward	SPX0710X-Z-3	Vari-Flow Lid O-ring (After 1976)	
O-2116	Waterway	805-0224	Heater Tailpiece 1 1/2" O-ring		Hyprieme	—	Lid O-ring	
	Conger	—	Mini Air Control O-ring		Muskin	54079	Large Filter O-ring	
	Hayward	CX0250-Z-7	Locking Knob Cartridge Filter O-ring		Sta Rite	—	Delrin Hi Prime H&L O-ring	
	Hayward	GMX0152-Z-5	Drain Plug O-ring (After 1979)		Sta Rite	U9-207	Cover O-ring	
O-2117	King	—	Kingfeeder Cam O-ring	O-2129	American	423160	Super Flo II Cartridge Filter Knob O-ring	
	Caretaker	6340113	Hydrostom Diffuser O-ring		American	570067	Commander Knob Seal O-ring	
	Hayward	SPX0724-G	End Connector O-ring		Grid	3008	Diverter O-ring	
O-2118	Laars	R0338805	Diffuser O-ring-3 HP		Regal	S-406	Chlorinator O-ring	
	American	477211	Cyclojet Large O-ring	O-2131	Jacuzzi	47-0126-04	DB3 Sleeve O-ring	
	Marlow	42925	Gemini O-ring		Regal	S-407	Chlorinator O-ring	
O-2119	Doughboy	308-1059	Dynaflow Cover O-ring	O-2133	American	510012	Multiport Valve Shaft O-ring	
	Luitweiler	—	Pump Lid O-ring		Hayward	SPX0603-Z-2	Stem O-ring	
O-2120	American	792071	Hi-Lite O-ring		Hayward	SX0200-Z-5	Filter O-ring	
	Astral	723R0700050	Sand Filter O-ring		Muskin	—	4 Way Valve Shaft O-ring	
	Sta Rite	35505-1323	Roto-trol Valve O-ring					

O-RINGS-LISTED IN SSC# ORDER

SSC#	FITS OEM	FITS OEM#	DESCRIPTION	SSC#	FITS OEM	FITS OEM#	DESCRIPTION
	Muskin	54062	Axle & Valve Shaft O-ring		Saurerman	—	2" Tube O-ring
	Pac Fab	15-4827	Air Relief O-ring		Speck	2302002062	Badujet O-ring
	Paddock	—	Petite Spin Filter Crank O-ring		Speck	2920141240	Model 90 Drain Plug O-ring
	Swimrite	38-828-752	Cap O-ring		Speck	412.9	Model 420 Drain Plug O-ring
	Waterway	715-1001	Air Relief O-ring		Sta Rite	P64-057	Paraport Valve Seal O-ring
	Waterway	805-0114	Top Load Filter Air Bleeder O-ring	O-2142	American	—	Commander 1 1/2" Volute Piston O-ring
O-2134	A.O. Smith	98198	Heater By-Pass O-ring		American	510104	Old Style Piston O-ring
	A.O. Smith	99660	Heater By-Pass O-ring		Anthony	17606	1 1/2" Piston & Valve Cap O-ring
	American	467150	Diverta Port Valve Puck O-ring		Coleco	31992	Top O-ring
	Doughboy	308-1006	Piston O-ring		Conger	—	Large Air Control O-ring
	Hayward	SPX1434-TP	O-ring		Jacuzzi	47-0220-09	Test Plug O-ring-TP1
	Jacuzzi	47-0326-02	Sand Trap Plug O-ring		Marine	—	Valve Piston O-ring
	Lomart	053-050	Backwash Valve O-ring		Premier	—	Premier 1 1/2" Cap O-ring
	Marine	—	Valve Piston O-ring		Sta Rite	35505-1233	Index Plate O-ring
	Muskin	037-3414	Valve O-ring		Sta Rite	U9-151	1 1/2" Piston O-ring
	Muskin	038-5434	O-ring		Sta Rite	U9-174	1 1/2" Valve O-ring
	Polaris	9-100-5139	Wall Bushing O-ring		Sta Rite	U9-376	Maxiglas II Shaft O-ring
	Praher	T15-E6	Diverter O-ring		Swimrite	30-828-752	Valve Cap O-ring
	Premier	P-2P	2" Piston O-ring		Swimrite	30-828-758	Autoflow Cap O-ring
	Raypak	800104	Raytemp O-ring For Piston Valve	O-2143	Hayward	SPX1705-Z-1	Pump Housing O-ring
	Richardson	—	Sand Filter Valve Adapter O-ring		Jacuzzi	47-0257-05	Separation Tank Support O-ring
	Sta Rite	35505-1313	2" Piston O-ring		Leslies	SPX1705-Z-1	Hydramax A/G Housing O-ring
	Sta Rite	U9-152	2" Valve O-ring		Premier	31-162	Booster Pump Volute O-ring
	Sta Rite	U9-371	Drain Cap O-ring	O-2144	Arneson	J-04	Valve Body O-ring
	Swimrite	30-828-753	2" Piston O-ring For Autoflow Valve		Hayward	GMX0600-D	Teflon Bearing Washer O-ring
	Swimrite	30-828-759	2" Piston O-ring		Hydro Air	10-5834	Mark II Jet Assembly O-ring
O-2135	American	—	Commander Air Relief O-ring		Letro	LJ-04	O-ring
	Arneson	F-24	Backup Extension O-ring		Polaris	D-24	Quick Connect O-ring
	Astral	721R0089019	Bolt O-ring		Poolsweep	J-04	O-ring
	Blue White	9003-009	Chlorinator O-ring	O-2146	Purex	71430	O-ring
	Doughboy	308-1152	Valve Cover Plunger O-ring		Ampro	300-6	Noryl Pump Body O-ring
	Hayward	ECX009611246	EC Filter Pump Shaft O-ring		Caretaker	413-0575	3/4-2 HP Diffuser O-ring
	Letro	LF-24	O-ring		Caretaker	634017	Hydrostorm Mounting Bracket O-ring
	Lomart	053-019	Shaft O-ring		Doughboy	308-1137	Lid Bushing O-ring
	Lomart	053-049	Valve Cover Plunger O-ring		Jacuzzi	47-0264-06	5-Watt Valve O-ring
	Rainbow	17-2221	RTL Filter Air Vent Valve O-ring		Jandy	R0338700	High Head Pump Body O-ring
	Rainbow	17-2224	O-ring		Lomart	053-180	Pro Pump O-ring
	Sta Rite	—	MK23 Crank O-ring		Muskin	54065	9" Plastic Tank O-ring
	Sta Rite	25575-0114	Drive Shaft O-ring	O-2150	Muskin	72033	9" Plastic Tank O-ring
	Sta Rite	35505-0114	Crank Shaft O-ring		American	860069	RPM Bulkhead O-ring
O-2137	King	106-100-007	King Tech Old Style Cap O-ring		Doughboy	308-1150	O-ring
	King	119	Old Style Cap O-ring		Hayward	SPX0410-Z-2	SP410X Large Piston O-ring
O-2138	Premier	31-160	100 Series Adapter O-ring		Lomart	053-185	O-ring
	Purex	71416	Eastside Seal Plate O-ring		Pac Fab	19-2122	1 1/2" Return Filter O-ring
	Sta Rite	35505-1263	XLII Pump Seal Plate O-ring	O-2152	Sta Rite	—	Verifilter Manifold O-ring
O-2139	AldenLeeds	O-6030	Divert-O-Trol Chlorinator O-ring		Sta Rite	U9-285	Trap Adapter O-ring
	Jacuzzi	47-0353-08	O-ring		Astral	723R0049003	Persius Sand Filter O-ring
	Jacuzzi	47-0353-40	Strainer Cover O-ring		Doughboy	308-1039	Hose Adapter O-ring
	Pac Fab	07-5848	Commercial R Diffuser O-ring		Hayward	SPX1500-W	Strainer Connector O-ring
	Pac Fab	35-4533	Dynamo, Dynamite Cover O-ring	O-2153	Leslies	SPX1500-W	Hydramax A/G Strainer O-ring
O-2140	Marlow	30156	1/2 & 1/3 HP Series Pump Diffuser O-ring		Richardson	5099-525	1/2" Valve Adapter O-ring
O-2141	Aqua Flo	92200060	O-ring		Speck	2920241220	Model 440 Union O-ring
	Blue White	9003-030	Chlorinator O-ring		Jacuzzi	47-0106-08	CFR Vent O-ring
	Doughboy	308-1011	Volute O-ring	O-2155	K-D Pools	47-0106-08	Cartridge Filter O-ring
	Hayward	SPX0602-Z-2	Valve O-ring		Baker Hyd	254760	Old Style Spa Pak Pump O-ring
	Hayward	SPX1441-Z-1	Valve Stem O-ring		Hayward	SPX0722-G	Ball Valve End Connector O-ring
	Hustler	A111	Small O-ring		Jandy	3381	Space Saver Valve O-ring
	Pac Fab	15-4661	Gauge & Air Bleeder Adapter		King	106-100-008	Cam O-ring
	Paraport	C64057	Bleeder Adapter O-ring		King	746	Cam O-ring
	Purex	—	CHD Crank O-ring		Lasco	—	2" PVC Union O-ring
	Rainbow	33-0017	Dynamic Chlorinator O-ring		Marlow	—	Mardur Pump Diffuser O-ring
					Purex	—	CHD 2" O-ring
					Purex	70345	O-ring
					Purex	71432	2" Valve Cap O-ring

O-RINGS-LISTED IN SSC# ORDER

SSC#	FITS OEM	FITS OEM#	DESCRIPTION	SSC#	FITS OEM	FITS OEM#	DESCRIPTION
O-2159	American	192320	Clean & Clear Plus Upper Bulkhead O-ring		Speck	2920141250	Casing O-ring Model 420
	Sta Rite	U9-203	Sand Filter O-ring		Sta Rite	—	Valve Piston O-ring
	Waterway	805-0145	2" Heater Tailpiece O-ring		Sta Rite	35505-0314	Q30 MK O-ring
O-2160	American	469150	Standard Air Control O-ring	O-2189	Sta Rite	35515-0314	Q30 MK Adapter O-ring
	Hayward	SPX0712	Vari Flo Pipe Socket O-ring		Acura	1660	Pump Union O-ring
O-2164	Hayward	GMX0400-F	Valve to Tank Lid O-ring		American	501521	1 1/2" Multiport II Valve O-ring
O-2165	Amer Gran	55-1150B55	2" Heat Sink O-ring		American	510058	Standpipe O-ring
	American	391028	Swivel Union O-ring		Aqua Flo	92200110	FM Series Suction O-ring
	American	467170	Diverta Port Valve Cap O-ring		Aqua Flo	FF-12-1	O-ring
	Baker Hyd	30C3119	2" Valve Plug O-ring		Caretaker	1132	Small O-ring
	Caretaker	413-0501	Mounting Bracket O-ring		Harmsco	784	2 1/8" O-ring
	Harmsco	783	2 1/2" O-ring		Lasco	—	1 1/2" PVC Union O-ring
	Hayward	SX0200-Z-4	S-160 & S-240 Sand Filter O-ring		Magic Vlv.	0301-226	1 1/2" Union O-ring
	Hyprime	—	Pot to Volute O-ring		Marine	1560	Deck Filter Manifold O-ring
	Jacuzzi	17-0228-68	Union O-ring		Marlow	40478	Gemini O-ring
	Jacuzzi	47-0228-01	Jet Charger 225 A, B, C O-ring		Pac Fab	15-5064	Tagelus Stand Pipe O-ring
	Jacuzzi	47-0228-35	Gyromat B/W Upper Valve O-ring		Pac Fab	15-5564	Star O-ring
	Jacuzzi	47-0228-68	Union O-ring		Premier	33-229	O-ring Set For Pump (O-2189 & O-2226 Make Set)
	Purex	—	N/S Tahitian Adapter O-ring		Premier	P-NPS	Small Pump Volute O-ring-Noryl
	Purex	71426	Collar & Rotor O-ring		Purex	71424	Cap O-ring
	Sta Rite	—	Float Valve O-ring		Purex	71440	Coupling O-ring
	Sta Rite	U9-205	Sand Filter Riser Tube O-ring		Sta Rite	35505-1238	FCP Cartridge Drain Plug O-ring
O-2167	Caretaker	634002	Hydrostorm Pot Lid O-ring		Sta Rite	U9-269	Cartridge Filter Drain Plug O-ring
	Marlow	44308	Argonaut Cover O-ring	O-2195	American	390040	Diffuser O-ring For Power Pump
	Martec	320-102	Trap Lid O-ring		American	468240	Power Glass Slip Body O-ring
	Premier	33-487	Clear Lid O-ring		Aqua Flo	—	Male Adapter O-ring
	Premier	33-489	6" Cover O-ring		Aqua Flo	92200140	O-ring
	Sta Rite	U9-046	6" Pump Lid O-ring		Aqua Flo	FF-17-03	O-ring
	Waterco	63151	Supatuf Pump H/L Pot O-ring		Aquatherm	17-051-003	O-ring
O-2170	Diaclear	8256-11	ES-7 Gorman Rupp O-ring		Baker Hyd	30C3018	TM 1 1/2" Center Tube O-ring
	Doughboy	308-1010	Pump O-ring		Baker Hyd	30C3019	1 1/2" Valve Plug O-ring
O-2172	Jacuzzi	47-0433-02	Filtromat O-ring		Grid	—	O-ring for 3050, 3051, 3052
	Pac Fab	35-2600	New Style 700 Pump Lid O-ring, P Series Lid O-ring		Hayward	SPX1425-Z-6	EC-65 Inlet Fitting O-ring
	Pac Fab	35-5332	Old Style Challenger Pump Lid O-ring		Hayward	SPX1485-B-6	Union Elbow O-ring
	Sta Rite	—	XLVII H & L Pot O-ring		Hydro Air	10-5857	O-ring
	Sta Rite	XL-VII	H&L Pot O-ring		Hydro Air	11-3429	O-ring
O-2175	American	510162	Directional Valve 2 & 3 Port O-ring		Hyprime	—	Impeller O-ring
	Compool	OR-6	Cover O-ring		Jacuzzi	47-0226-03	Inlet Fitting Seal O-ring
	Grid	3009	Cover O-ring		Martec	410-511	Bathmaster Jet Body O-ring
	Jandy	1132	Vinyl Cover O-ring		Martec	700-103	Union O-ring
	Polaris	E-30	Backup Valve Case O-ring		Pac Fab	35-4571	Dynamo Adapter O-ring
	Polaris	E-31	Backup Valve O-ring-1986-91		Premier	21-502	1 1/2" Cap O-ring
	Purex	72551	Mixing Valve Liftlock O-ring		Premier	29-674	1 1/2" Tailpiece O-ring
	Sta Rite	35505-0198	3 Port Actuator O-ring		Sta Rite	U9-226	Duraglass Diffuser, Quantum Spa, Cart. O-ring
O-2177	American	470628	Luxury Spa Jet O-ring		Sta Rite	WC20-24	Pump O-ring
	Cal Pump	—	Volute O-ring-A180, 210A		Vico	UPULO/R2	Ultra Flow 2" Union O-ring
	Diaclear	DP-46350	Slide Valve Cover O-ring		Waterway	805-0226	Union O-ring
	Starbright	—	Skim Filter Manifold O-ring		Waterway	805-0226	1 1/2" Union Tailpiece O-ring
O-2181	Jacuzzi	47-0380-47	CFT Cover O-ring	O-2199	Hayward	DEX0360-M	Bulkhead Fitting O-ring
	K-D Pools	47-0380-47	Cartridge Filter O-ring		Jacuzzi	47-0142-04	2" Valve O-ring
O-2185	Hayward	SPX1905-E	Self Drain Pump Housing O-ring	O-2200	Doughboy	308-1174	4 Position Valve Stem O-ring
O-2186	Hayward	DEX0360-E	Bulkhead Fitting O-ring		Harmsco	552	Holding Rod O-ring
O-2187	Premier	31-161	200 Series MK2 Volute O-ring		Speck	2991300005	Badustar 913 Cartridge O-ring
O-2188	Anthony	17786	Plastic Valve Plunger Rod O-ring	O-2201	Diaclear	C-10146	MS-12 to MS-18 O-ring For C10145
	Anthony	17792	2" Brass Push-Pull Valve O-ring	O-2203	Anthony	—	New Style Piston O-ring
	Baker Hyd	00B7014	Valve Piston O-ring (For Kit Order 3)		Coleco	33236	Strainer Inlet O-ring
	Harmsco	551	Standpipe O-ring		Doughboy	308-1061	Dynaflow Basket Port O-ring
	Hayward	GMX0142-Z-2	Pump O-ring		Jacuzzi	47-0218-11	Air Control O-ring
	Purex	70212	OOB7014 Valve Piston O-ring		Jacuzzi	47-0218-45	Air Control O-ring
					Plastiline	—	3/4 Union O-ring
				O-2205	Blue White	9003-020	Chlorinator O-ring
					Doughboy	308-1013	Pump Discharge O-ring

O-RINGS-LISTED IN SSC# ORDER

SSC#	FITS OEM	FITS OEM#	DESCRIPTION	SSC#	FITS OEM	FITS OEM#	DESCRIPTION	
O-2208	Fischer	101W910U01	Chlorinator O-ring	O-2219	Swimrite	60-828-715	5" Pump Lid O-ring	
	Jacuzzi	47-0022-09	Shaft Sleeve O-ring		Pac Fab	19-5007	4" Diameter Adapter O-ring	
	American	468155	Aqua Lumin Light O-ring		O-2220	Arneson	E-43	Turbo Sweep Seal Plate O-ring
	American	510059	Air Relief Valve Sep. Tank O-ring			Astral	721R0195030	Light O-ring
	Arneson	G-12	Gear Housing O-ring		Blue White	9003-067	Chlorinator O-ring	
	Blue White	9003-003	Chlorinator O-ring		Compool	OR-4	Shaft O-ring	
	Hayward	SPX0072-Z-4	Sight Glass O-ring		Doughboy	308-1054	Drain Valve O-ring	
	Laars	S-328	Heater O-ring		Jacuzzi	47-0016-05	1 1/2" Valve O-ring	
	Letro	LG-12	O-ring		Jacuzzi	47-0016-06	Filtromat Cover O-ring	
	Olympic	ACM94-7	Chlorine Feeder Valve O-ring		Jacuzzi	47-0116-05	Valve O-ring	
	Purex	71419	Whisperflow Lock Screw O-ring		Jacuzzi	47-0116-30	Dial Valve O-ring	
	Purex	75713	Whisperflo O-ring		Jacuzzi	47-0117-05	Shaft O-ring	
	Sta Rite	35575-1114	Shaft O-ring-MK37, 47, 57 Series		Jandy	1307	Shaft O-ring	
	O-2209	Acura	1061		Magna Faceplate O-ring	Letro	LE-43	Turbo Sweep O-ring
Doughboy		308-1124	Cyclops Mark 5 O-ring	Martec	201-002	Bleed Plug O-ring		
Hayward		SPX1580-Z-1	Powerflo Housing O-ring	Pac Fab	—	Crankshaft O-ring		
Jacuzzi		47-0258-04	O-ring	Pac Fab	02-116	Crankshaft O-ring		
King		942	King Tech Body Cap O-ring-Perform.	Pac Fab	19-2039	SCS Spin Filter Crank O-ring		
Lomart		053-132	Cyclops Mark 5 O-ring	Poolsweep	E-43	Turbo Sweep O-ring		
Polaris		P-95	Volute O-ring	Purex	71428	Tahitian Cap & Rotor Shaft O-ring		
Premier		35-162	Volute O-ring	Purex	72552	Shaft Liftlock O-ring		
Purex		71417	AT Series Pump B/V O-ring	Speck	2920141230	Filter Plug O-ring		
Purex		71427	Aquatron Pump B/V O-ring	O-2221	Aqua Flo	92200160	O-ring	
Sta Rite		35505-1275	Cover O-ring For M/V WC112-147	Hayward	—	Center Rod O-ring		
Vico		PPBFV/OR	Big Foot Pump O-ring	Jacuzzi	47-0213-08	S/W Injection Plug O-ring		
Wallace		44121	Chlorinator O-ring	Purex	71434	Noryl Rotor Shaft O-ring		
O-2210		American	501517	Lid O-ring	Speck	2923441200	Model 21-80 O-ring	
	Praher	T15-E3	Cover O-ring	O-2222	American	—	Air Relief Valve O-ring	
	Sta Rite	—	Dial Valve O-ring	American	—	Air Relief Valve O-ring		
	Sta Rite	14962-35	Large O-ring For Kit	Blue White	C-350	Check Ball O-ring		
	Waterway	805-0254	Top Mount Valve Lid O-ring	Jacuzzi	47-0008-07	CFR Air Vent O-ring (Prior 1/88)		
	Doughboy	308-1012	#1110D Tank O-ring	Jacuzzi	47-0080-76	O-ring		
	Jacuzzi	47-0161-00	DA1A-DA1B Case O-ring	Marine	166-6	Thermometer O-ring		
	Vico	PPSFV/OR	Super Flo Pump O-ring	Sta Rite	35505-1009	Hydro-Valet Face Plate Inlet O-ring		
	O-2212	Anthony	04412	AR Seal Plate O-ring	O-2223	American	570078	Commander Center Rod O-ring
	Anthony	U9-169	Seal Plate O-ring	Baker Hyd	—	Newport Valve Shaft O-ring		
	Aqua Flo	92200290	FMXP Pump Volute O-ring	Hayward	—	Cartridge Filter Center Rod O-ring		
	Jandy	R0340400	Medium Head Body O-ring	Hayward	CX0250-Z-6	O-ring		
	King	01-22-9426	Body O-ring ('91 & Prior)	Laars	E-363	Heater O-ring		
	Pac Fab	35-4535	Dynamo Bracket Diffuser O-ring	Purex	71449	Tahitian Filter Shaft O-ring		
O-2215	Waterco	635028	Supatuf Pump Body O-ring	O-2224	American	510119	Standpipe O-ring	
	Cal Pump	11190	Volute O-ring-5580, 900, 1220-S	American	850151	S-20 Skimmer Bottom O-ring		
	Pac Fab	19-2320	Stainless Steel DE Filter O-ring, Bulkhead O-ring	Astral	690R0406	Sand Filter O-ring		
	Waterway	805-0145	2" Union Connector O-ring	Astral	710R0402	O-ring		
	Doughboy	308-1014	1141 & 1162 MY185RP Cartridge O-ring	Caretaker	413-0620	Lid O-ring		
	Purex	71445	Whisperflo Seal Plate O-ring	Jacuzzi	47-0358-03	Magnum Pump O-ring (After 7/89)		
	A&A Mfg.	820-115	Water Valve O-ring	Jacuzzi	47-0359-02	PM Filter Valve O-ring		
	Airquatic	5099-149	FG Filter Lid O-ring	Jandy	R0338900	Pot Lid O-ring		
	Pac Fab	15-2501	Valve Adapter O-ring-TA100D	King	01-22-9926	Cap O-ring (Current)		
	Sta Rite	U9-241	Pump O-ring	King	992	400/430, 940 Cap O-ring		
	O-2218	American	391019	Maxim, Americana II Lid O-ring	Pac Fab	35-3525	Old Style Porpoise Filter Clear Lid O-ring	
	Anthony	04387	AC2, AS2 5" Strainer Cover O-ring	O-2226	Acura	1062	Magnaflow 2" Union O-ring	
	Anthony	U9-161	Centrifugal Pump Trap Cover O-ring	American	570082	Admiral Twin Port Skimmer S20 Equalizer		
	H & F	—	Pump O-ring	Aqua Flo	92200100	FM, B Series Suction O-ring		
Landon	—	Pump Lid O-ring	Aqua Flo	FF-12	O-ring			
Lomart	—	Pump Lid O-ring	Astral	7730599035	Astra Max O-ring			
Luitweiler	—	Pump O-ring	C & R	20-2056	2" Union O-ring			
Sta Rite	U9-161	5" Pump Trap Lid O-ring	Doughboy	308-1008	Valve Body O-ring			
			Hydro Air	11-3469	O-ring			
			Jacuzzi	47-0229-00	O-ring			
			Jacuzzi	47-0467-01	Dial Valve O-ring			

O-RINGS-LISTED IN SSC# ORDER

SSC#	FITS OEM	FITS OEM#	DESCRIPTION	SSC#	FITS OEM	FITS OEM#	DESCRIPTION
	Martec	700-203	Sonfarrel 2" Union O-ring		WMC	621462	Hydro Sand Filter Sight Glass O-ring
	Martec	700-308	2" Tailpiece O-ring				
	Pac Fab	35-5330	Challenger Pump Strainer Pot Flange O-ring	O-2243	Arneson	K-965	Body O-ring
	Premier	—	Large & Spa II O-ring		Hayward	SPX0727-K	Valve O-ring
	Premier	25-229	2" Tailpiece O-ring		Hayward	SPX0728-H	End Connector O-ring
	Premier	P-NPL	Large Noryl Pump Volute O-ring		King	106-100-019	Basket O-ring
	Regal	S-409	Chlorinator O-ring		King	722	Basket O-ring
	Sundance	6560-044	Hi-Flo Heater Union Fitting O-ring	O-2247	Purex	72557	Ortega Valve Equalizer O-ring
	Waterway	805-0229	2" Heater Tailpiece O-ring		Purex	P-26136	Ortega Equalizer O-ring
O-2227	American	469115	Air Control O-ring		Anthony	HL6	6" Pump Lid O-ring
	Blue White	9003-051	Chlorinator O-ring		Aqua Flo	92200010	A & AC Series 6" Trap Cover O-ring
O-2228	Aqua Flo	92200000	A Series 5" Trap Cover O-ring		Aqua Flo	AF-10-01	O-ring
	Aqua Flo	AF-10	5" Lid O-ring		Hayward	SPX3000-S	SP3000 Pump Lid O-ring
	Bio Lab	25475HYD	Brominator Lid O-ring		Hydropump	—	6" H & L Trap O-ring
	Bio Lab	B-94	Brominator Lid O-ring		Jacuzzi	47-0438-07	Cast Iron Pump Lid O-ring
	Guardex	25475HYD	Brominator Lid O-ring		Leslies	SPX3000-S	Hydramax II Cover O-ring
	Guardex	B-94	Brominator Lid O-ring		Pac Fab	HL6	Hydro 6" H&L Trap O-ring
	Hydrotech	25475HYD	Brominator Lid O-ring		Purex	—	Eastside 6" H&L Trap O-ring
	Hydrotech	B94	Brominator Lid O-ring		Purex	71421	PJ-18 Pump Lid O-ring
	Marine	—	5" Clear Lid O-ring		Sta Rite	—	Old Style 6" Lid O-ring
	Premier	31-486	5" Cover O-ring		Sta Rite	U9-375	Maxi Glass II Trap O-ring
	Sta Rite	—	5" Clear Lid O-ring		Sta Rite	U9-399	Maxi Glass Trap O-ring
	Sta Rite	35505-1344	O-ring	O-2248	Wet Inst.	34-050-303	Pump O-ring
	Swimrite	—	5" Clear Lid O-ring		Ampro	—	900-9S Small Spool O-ring
O-2231	American	850057	Manifold O-ring		Blue White	9003-011	Chlorinator O-ring
	American	862005	Manifold O-ring		Blue White	C-502	Tube Adapter O-ring
	Anthony	17681	3/16" Piston & 2" Cap O-ring		Hayward	GMX0400-P	Flange Mount Valve Stem O-ring
	Doughboy	308-1046	O-ring		Hayward	GMX0600-P	GM-600 Valve O-ring
	Hayward	SPX1483-C	Valve Union O-ring	O-2249	Jacuzzi	47-0013-00	Drain Plug O-ring
	Jacuzzi	47-0223-06	Filter Valve O-ring		American	392014	Lid O-ring
	Kreepy	12-800	Swivel Housing O-ring		Nature 2	2-13073	Cap O-ring
	Monarch	—	New Style Impeller O-ring		Premier	—	550 6" Lid O-ring
	Paddock	—	Star Clear Tube & Manifold O-ring		Premier	P-13-6P	Clear Lid O-ring
	Purex	71431	800 Series Manifold O-ring		Purex	71423	Flange O-ring
	Saurerman	—	Backwash Valve Valve O-ring	O-2252	Speck	2920741210	Model 423 Lid O-ring
	Sta Rite	35505-1236	Sil. Seal & Capri Return O-ring		Acura	1060	Maverick Pump Face Plate O-ring
	Sta Rite	35505-1429	Elbow Assembly O-ring		Aqua Flo	92200150	Volute O-ring
	Sta Rite	U9-199	Diffuser O-ring		Aqua Flo	92200270	FMCP Volute O-ring
O-2234	Jacuzzi	47-0144-02	2" Multiport Valve O-ring (Prior to 8/73)		Hayward	SPX1082-Z-5B	Powerflo Volute O-ring (Before 1986)
	Purex	74021	CFM Manifold O-ring		Jacuzzi	47-0251-01	Press Molder Lint Catcher O-ring
O-2236	Jacuzzi	47-0355-06	1 1/2" Sandtrap Filter Lid O-ring		Martec	310-104	Booster Pump O-ring
	Jacuzzi	47-0355-48	PH Series Cover O-ring		Sta Rite	—	XL-VII Bracket to Volute O-ring
O-2239	American	550067	Sahara Drain Filter O-ring		Sta Rite	U9-114	Pump O-ring
	American	570068	Eclipse O-ring		Sta Rite	U9-167	Pump O-ring
	Astral	722R0198035	O-ring	O-2253	American	792005	O-ring
	Astral	722R0198036	Multiport Valve Rotor Axle O-ring		Aqua Flo	92200120	Pipe Plug O-ring
	Electrofeed	—	25 A Fitting O-ring		Hayward	DEX2400-Z-3A	Micro Clear DE O-ring
	Hayward	CX0900-H	Star Clear Plus O-ring		Letro	LA-375	Booster Pump Drain Plug O-ring
	Hustler	A211	Large O-ring		Pac Fab	27-2707	1 1/4" Hi Flow Valve Knob O-ring
O-2240	Sta Rite	35505-1223	2" Valve Stem O-ring		Arneson	K-966	Element O-ring
	Anthony	—	4" Pump Lid O-ring	O-2254	Astral	00091R0204	O-ring
	Doughboy	308-1004	H&L Pot O-ring		International	—	Collection Tube O-ring
	Jacuzzi	47-0347-07	Gyromat O-ring		Jacuzzi	47-0028-03	Filter Valve O-ring
	Pac Fab	HL4	4" H&L Trap O-ring		Sta Rite	35505-0239	Skimmaster Tube O-ring
	Purex	—	Eastside 4" H&L Trap O-ring	O-2255	Doughboy	308-1002	Lid Bushing O-ring
	Sta Rite	—	4" Old Style Pump Lid O-ring		International	—	Lower Piston O-ring
O-2242	Hayward	SPX0733-Z-1	Valve Key O-ring		Jacuzzi	47-0216-05	Verturi O-ring
	Jacuzzi	47-0118-04	S/W Injectors O-ring		Sta Rite	14962-35	Small O-ring For Kit
	Letro	LLU7	Feed Mast O-ring		Sta Rite	35505-1228	Dial Valve O-ring
	Martec	400-108	Reed Valve O-ring		Swimrite	—	Old Style Lower Piston O-ring
	Waterco	621462	Gray Valve Sight Glass O-ring				
	WMC	62133	Hydro Sand Filter Sight Glass O-ring				

O-RINGS-LISTED IN SSC# ORDER

SSC#	FITS OEM	FITS OEM#	DESCRIPTION	SSC#	FITS OEM	FITS OEM#	DESCRIPTION
O-2256	Advance American	OV-11-212 501414	Chlorinator O-ring 1 1/2" Multiport Valve T/M Series O-ring		Sta Rite WMC	U9-357 62100	Dura Jet Seal Plate O-ring Hydron Sand Filter Neck O-ring
	American	501519	Rotor O-ring	O-2270	Aqua Flo Conger	92200210 —	O-ring O-ring-2 3/4" OD x 1/8" TH
	American	510026	Valve O-ring		Hayward	SX0200-Z-3	Filter O-ring
	American	510177	2" Valve Stem O-ring		Magic Vlv.	0301-227	2" Union O-ring
	American	982207	2" P Valve Shaft O-ring		Monarch	—	Pump to Volute O-ring
	Baker Hyd	30C3009	1 1/2" Multiport Valve Shaft O-ring		Purex	72560	2" Ortega Valve Cap O-ring
	Baker Hyd	30C3109	2" Multiport Valve Shaft O-ring	O-2271	Sta Rite	U9-265	C Series Shaft O-ring
	Conger	—	O-ring- 1 1/8" OD x 1/8" TH	O-2272	Jacuzzi	47-0348-06	Multiuse Pump & Filter O-ring
	Hayward	SPX0735-G	Valve Stem O-ring	O-2278	Jacuzzi	47-0370-07	2" Multiport Valve O-ring
	Jacuzzi	47-0212-09	RM2, 3 S/W Injector O-ring		Richardson	5099-149	Sand Lid O-ring
	Jacuzzi	47-0465-03	Diverter Dial Valve O-ring	O-2280	Hayward	SPX0735-H	Ball Valve Connector O-ring
	Muskin	54067	FP Parker Pump O-ring		Sta Rite	—	Plastic Slide Valve Cap O-ring
	Pac Fab	—	Multiport Valve Shaft Seal O-ring		Sta Rite	—	Index Plate Large O-ring
	Pac Fab	19-1479	Star DE Filter Shaft O-ring		Sta Rite	35505-1246	Turbo Clean Head O-ring
	Pac Fab	27-1162	Valve Stem O-ring		Waterway	805-0232	2 1/2" Union O-ring
	Wallace	46129	Chlorinator O-ring	O-2281	Blue White	9003-024	Chlorinator O-ring
O-2257	Blue White	9003-016	Chlorinator O-ring	O-2282	Anthony	—	Old Style Light Base O-ring
	Jacuzzi	47-0020-01	K Series Filtromat O-ring		Caretaker	1133	Union O-ring
O-2259	Jacuzzi	—	Plastic Multiport Stem O-ring		Hayward	SPX1500-N	O-ring
	Regal	S-405	Chlorinator O-ring		Hayward	SX0220-Z-3	Pro Filter O-ring
	Sta Rite	U9-370	Lateral O-ring		Omni	0-5960	Chlorinator O-ring
O-2261	Hayward	SPX0605-Z-2	Stem O-ring		Pac Fab	—	Nautlius Lower Pipe Assembly O-ring
	Hayward	SX0200-Z-14	1980 O-ring		Pac Fab	15-4492	2" Bulkhead O-ring
	Marine	—	Old Style Crank O-ring		Plastiline	—	2" Union O-ring
	Pac Fab	27-2511	1 1/2" Hi Flow Shaft O-ring		Purex	B-94	Regular Lid O-ring
	Sta Rite	77707-0117	Pool Heater O-ring (for kit order 6)		Sta Rite	—	HRV 24 O-ring
O-2262	American	421612	Power Glass Volute O-ring		Sta Rite	WC9-007	Sand Filter O-ring
	Aqua Flo	92200090	FMH Series Volute O-ring	O-2283	Laars	S-735	O-ring
	Aqua Flo	FF-11	O-ring		Pac Fab	15-4004	Triton C-3 Filter O-ring
	Brett	100022K	EM203 Pump O-ring	O-2286	Doughboy	308-1052	Strainer Body O-ring-1984
	Diaclear	C-10139	MS-16 & MS-18 Cover O-ring		Doughboy	308-1067	Power Pak 2 Lid O-ring
	Pac Fab	35-2626	Backwash Valve O-ring/Volute O-ring		Doughboy	308-1167	Power Pak 2 Lid O-ring
	Premier	31-158	Volute O-ring		Pac Fab	35-4634	Bracket Diffuser O-ring-After 12/93
O-2263	Arneson	G-32	Lower Bearing O-ring	O-2287	Polaris	9-100-5108	Hose Nut, Cuffless Hose O-ring
	Doughboy	308-1044	O-ring	O-2288	Jacuzzi	47-0021-00	Air Control Valve Seat O-ring
	Letro	LG-32	O-ring	O-2292	Olympic	ACM-94-5	Chlorinator Cover O-ring
	Pool sweep	G-32	O-ring		Pac Fab	27-2541	Valve Body O-ring
	Waterway	805-0123	Tailpiece Union O-ring				TA30/35/40/50/60
O-2264	American	—	Americana Spacemaker O-ring	O-2293	Jacuzzi	47-0443-00	Sandtrap Filter V/A O-ring
	Coleco	31954	Top O-ring		Speck	2920941210	Lid O-ring
	Doughboy	308-1062	Cartridge Filter Coupling O-ring	O-2294	Martec	205-106	Filter Head O-ring
	Jacuzzi	47-0123-07	RM2 Injector Cap O-ring (As of 11/91)		Pac Fab	35-5619	Pinnacle Seal Bracket O-ring
	Jacuzzi	47-0212-66	O-ring	O-2295	Jacuzzi	47-0165-06	D83 Case O-ring For DB1 Pump
	Jacuzzi	47-0214-07	Valve Stem O-ring	O-2297	American	510167	Multiport Valve 2" Lid O-ring
	Marine	1150	Locknut O-ring		Sta Rite	35505-1412	Lid O-ring Multiport Valve Side Mount O-ring
	Pac Fab	19-2040	Crank Cap O-ring		Sta Rite	35505-1421	Lid O-ring For 2" Side Mount Valve
	Rainbow	17-2451	Check Valve O-ring	O-2300	Arneson	W-542	Pool Vac O-ring
	Swimrite	28-828-681	Marathon Grid O-ring		Jacuzzi	47-0361-08	RP3 Case O-ring
	Waterco	621457	Gray Valve Shaft O-ring		Jacuzzi	47-0361-48	Cygnat O-ring
	WMC	621457	Hydron Sand Filter Axle O-ring	O-2301	Acura	1081	Aquaheat Diffuser O-ring
O-2266	Astral	773R1450050	Sand Filter O-ring	O-2302	Pac Fab	27-3512	Nautlius Air Bleeder O-ring
	Coleco	33221	Pump O-ring		Pac Fab	27-3513	Air Bleeder Screw O-ring
	Gulf	352501903	Power Tech 2 Lid O-ring	O-2303	Pac Fab	27-3514	Stainless Steel Sand Filter O-ring
	Jacuzzi	47-0357-04	Pump Lid O-ring				
	Jacuzzi	47-0357-46	JC Pump Housing O-ring	O-2304	Speck	2920341220	Model 400 2 Bolt O-ring
	Jacuzzi	47-0433-51	USLB 6" Lid O-ring		Speck	2920841210	433T Lid O-ring
	K-D Pools	47-0357-46	K Square Ring		Speck	2921141210	90 Lid O-ring
	Pac Fab	35-4053	700 Glass Pump Lid O-ring	O-2305	Speck	2920341225	Model 400 4 Bolt O-ring
	Sta Rite	35505-1402	O-ring		Sta Rite	U9-373	Dynaglass Seal Plate O-ring
	Sta Rite	35505-1438	ABG Pump Seal Plate O-ring	O-2306	Hayward	CX0900-F	Filter Head O-ring
	Sta Rite	U9-211	Sand Filter Cover O-ring		Premier	31-418	Renegade 725 O-ring

O-RINGS-LISTED IN SSC# ORDER

SSC#	FITS OEM	FITS OEM#	DESCRIPTION	SSC#	FITS OEM	FITS OEM#	DESCRIPTION
	Premier	31-420	Renegade Volute O-ring	O-2419	Sta Rite	35515-0318	Collection Tube Quad Ring
	Sta Rite	U9-228A	P2R Pump Housing O-ring		Sta Rite	35515-0514	Collection Tube Quad Ring
O-2307	Hayward	CX0400-G	Cover O-ring	O-2420	Muskin	54040	5 Position Valve Quad Ring
	Speck	2921141220	Model 90 Casing O-ring	O-2502	Advance	OV-11-012	Chlorinator Viton O-ring
O-2308	Speck	2920241210	O-ring		Fischer	101W707U01	Chlorinator Viton O-ring
O-2309	Gulf	352501904	Power Tech 2 Knob O-ring		Regal	S-403	Chlorinator Viton O-ring
	WMC	JS-1571	JS Pump Knob O-ring		Wallace	26482	Chlorinator Viton O-ring
O-2310	Caretaker	1131	Large O-ring	O-2503	Advance	OV-11-006	Chlorinator Viton O-ring
O-2321	Hydro Air	10-027EP70	Butterfly Jet O-ring		Fischer	101W701U01	Chlorinator Viton O-ring
O-2324	Cal	10240	Volute O-ring-A280, 320, 430-A		Regal	S-301	Chlorinator Viton O-ring
	Rainbow	R37121	Concorde Plate O-ring	O-2504	Hayward	CLX0110-K	Chlorine Feeder Viton O-ring
O-2326	Rainbow	R37009	Concorde Motor Housing O-ring	O-2505	Advance	OV-11-028	Chlorinator Viton O-ring
	Polaris	6-412	Vac Sweep O-ring		Regal	S-411	Chlorinator Viton O-ring
O-2329	Pac Fab	27-5300	Full Flow Valve O-ring	O-2506	Advance	OV-11-011	Chlorinator Viton O-ring
O-2332	Speck	2921641210	E91 Pump Lid O-ring		Fischer	101W706U01	Chlorinator Viton O-ring
O-2345	Hercules	755314	O-ring		Regal	S-402	Chlorinator Viton O-ring
O-2346	Jacuzzi	47-0255-07	DVK-7 O-ring		Wallace	26234	Chlorinator Viton O-ring
	Muskin	275-0007	6 Position Valve Cover O-ring	O-2507	Advance	OV-11-008	Chlorinator Viton O-ring
O-2355	Hayward	SX0360-Z-1	O-ring		Regal	S-302	Chlorinator Viton O-ring
O-2365	Letro	LL-13	Housing Body O-ring		Wallace	30343	Chlorinator Viton O-ring
O-2369	Letro	JV-11	Jet Vac O-ring	O-2508	Advance	OV-11-110	Chlorinator Viton O-ring
O-2373	Jacuzzi	47-0175-04	SC Series Case O-ring		Wallace	31702	Chlorinator Viton O-ring
O-2374	American	271151	2" P Valve Lid O-ring	O-2510	Fischer	101W904U01	Chlorinator Viton O-ring
	American	510023	O-ring		Wallace	31882	Chlorinator Viton O-ring
	Baker Hyd	30C3105	2" Multiport Valve Cover O-ring	O-2511	Hayward	CLX0200-K	Chlorinator Viton O-ring
	Jacuzzi	47-6172-04	Top O-ring for Sandstorm 31 Filter	O-2512	Fischer	101W709U01	Chlorinator Viton O-ring
	Pac Fab	27-1151	Cover O-ring		Wallace	30066	Chlorinator Viton O-ring
	Waterway	805-0261	Executive 56 Pump Volute O-ring	O-2514	Fischer	101W716U01	Chlorinator Viton O-ring
O-2375	American	873004	Predator Body O-ring	O-2515	Advance	OV-11-210	Chlorinator Viton O-ring
O-2376	Pac Fab	15-4693	Knob O-ring		Fischer	101W715U01	Chlorinator Viton O-ring
O-2378	American	501523	Meteor Hose Assembly O-ring, Sight Glass O-ring		Hayward	SPX0605-Z-2V	Drain Plug O-ring-Viton
O-2381	Nature 2	2-13035	Model G Purifier Inlet O-ring		Wallace	26822	Chlorinator Viton O-ring
	Speck	2991500001	Bearing O-ring	O-2516	Advance	OV-11-203	Chlorinator Viton O-ring
O-2386	Sta Rite	35505-1426	Impeller Screw O-ring		King	943	King Feeder Performax Drain Plug Viton O-ring
O-2387	Pac Fab	07-5846	Commercial R Seal Plate O-ring, Sight Glass O-ring	O-2517	Regal	S-412	Chlorinator Viton O-ring
O-2388	Waterway	805-0383	Clearwater DE, Cartridge Top O-ring		Fischer	101W902U01	Chlorinator Viton O-ring
O-2389	Pac Fab	07-5847	Commercial R Lid O-ring		Wallace	39648	Chlorinator Viton O-ring
O-2390	Jandy	R0353400	CT Series Cartridge Filter Lid O-ring	O-2518	Hayward	SPX3000-SV	Chlorinator Cover Viton O-ring
O-2401	Doughboy	308-1018	Manifold Quad Ring	O-2519	Advance	OV-11-112	Chlorinator Viton O-ring
O-2402	American	530018	Female Bell Quad Ring		E-Z Chlor	918	Flowmeter Viton O-ring
	Marine	1350	990MS & BH Filter Quad Ring		Fischer	101W710U01	Chlorinator Viton O-ring
O-2403	Sta Rite	35515-1296	Valve Connector Quad Ring		Wallace	26345	Chlorinator Viton O-ring
O-2404	American	395004	Seal Plate Quad Ring (Prior to 1975)	O-2520	Advance	OV-11-009	Chlorinator Viton O-ring
O-2405	Sta Rite	—	Spin Filter Tube Quad Ring		Fischer	101W704U01	Chlorinator Viton O-ring
	Sta Rite	Q4327	Manifold Quad Ring		Regal	S-401	Chlorinator Viton O-ring
O-2406	Sta Rite	35505-0114	Crank Shaft Quad Ring		Wallace	33051	Chlorinator Viton O-ring
	Sta Rite	35515-0114	Crankshaft Quad Ring		Wallace	34497	Chlorinator Viton O-ring
	Sta Rite	Q4112	Large Crank Quad Ring		Wallace	44119	Chlorinator Viton O-ring
	Starbright	—	Crank Quad Ring	O-2521	Advance	OV-11-010	Chlorinator Viton O-ring
O-2408	Pac Fab	35-2602	Old Style RPZ 590 5" Pump Lid Quad Ring		Fischer	101W705U01	Chlorinator Viton O-ring
O-2409	Pac Fab	35-5030	MH Challenger Diffuser Quad Ring		Wallace	25900	Chlorinator Viton O-ring
	Sta Rite	35515-1297	CFP Cartridge Filter Valve Connector Quad Ring		Wallace	41106	Chlorinator Viton O-ring
O-2410	American	510010	New Style Quad Ring	O-2522	Rainbow	17-2009	Chlorinator Lid Viton O-ring
O-2411	Sta Rite	—	Upright Spin Crank Quad Ring	O-2523	King	01-22-1920	New Water Cap O-ring, B-192 Ser. 100/200 Cap O-rng
O-2412	Sta Rite	35515-0317	Filter Collection Tube O-ring		King	192	New Water Cap Viton O-ring
O-2414	Muskin	—	4 Way Valve Seat Quad Ring	O-2524	Bio Lab	PC25350	MA Chlorinator Cover Viton O-ring
O-2417	Marine	1340	990MS & BH Filter Quad Ring		Waterway	805-237V	Clearwater Feeder Viton Lid O-ring
				O-2604	American	392014	Blue Teflon Coated Lid O-ring
					Premier	—	550 Blue Teflon Coated 6" Lid O-ring
					Purex	71423	Blue Teflon Coated Flange O-ring
				O-2605	Muskin	037-3412	Blue Teflon Coated Strainer Pump Lid O-ring

O-RINGS-LISTED IN SSC# ORDER

SSC#	FITS OEM	FITS OEM#	DESCRIPTION
O-2607	Fischer	101W718U01	Chlorinator Viton O-ring
	Wallace	44045	Chlorinator Viton O-ring
	Wallace	5745	Chlorinator Viton O-ring
O-2608	Fischer	101W918U01	Chlorinator Viton O-ring
	Wallace	40040	Chlorinator Viton O-ring
O-2609	Fischer	101W901U01	Chlorinator Viton O-ring
	Wallace	38437	Chlorinator Viton O-ring
O-2610	Fischer	101W920U01	Chlorinator Viton O-ring
O-2611	Wallace	26784	Chlorinator Viton O-ring
O-2612	Fischer	101W903U01	Chlorinator Viton O-ring
O-2614	Fischer	101W721U07	Chlorinator Viton O-ring
O-2615	Fischer	101W905U01	Chlorinator Viton O-ring
O-2616	Wallace	45336	Chlorinator Viton O-ring
O-2618	Baker Hyd	31B1107	Spa Pak Pump Diffuser Gasket
	Gulf	352506104	Power Tech Diffuser Gasket
	Hayward	SPX1600-R	Super Pump Diffuser Gasket
	Hayward	SPX3500-K	Super Spa Pump Diffuser Gasket
	Leslies	SPX1600-R	Hydramax II Diffuser Gasket
	WMC	SS-1600-R	Diffuser Gasket-AT

A Picture is Worth a Thousand Words...

Our Gasket Picture Guide (pgs. 57-67) shows all of the gaskets we offer in SSC# order. Gasket dimensions are also included for proper identification.

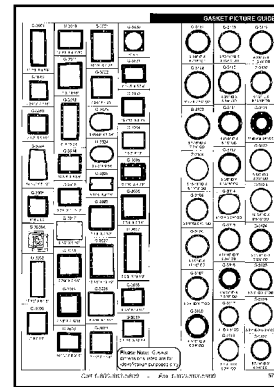

LAMINATED O-RING SIZING GUIDE

Use this guide to identify any loose O-rings you have lying around. The guide is laminated for protection and all O-rings are shown life size with the SSC number clearly marked. The guide is 8 pages long.

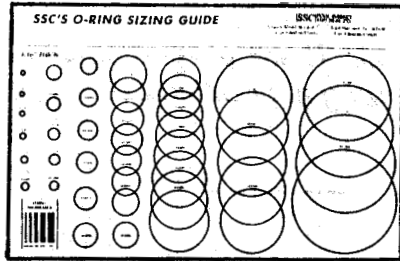

ORG-1
LAMINATED O-RING
SIZING GUIDE
8 Pages

If we are missing the part you need, let us know and we'll tool up for it.

GASKETS-LISTED IN SSC# ORDER

SSC#	FITS OEM	FITS OEM#	DESCRIPTION	SSC#	FITS OEM	FITS OEM#	DESCRIPTION
G-3001	Hayward	SPX1085-D	Skimmer Gasket	G-3109	Pac Fab	35-3514	880-881 Bracket to Volute Gasket
	Jacuzzi	13-0010-03	Skimmer Gasket	G-3110	Pac Fab	35-3515	Backwash Valve Pump Gasket
G-3002	Hayward	SPX1094-G	Skimmer Gasket-Fiber	G-3111	Marlow	22991	Motor to Lantern Shim Gasket
	Rainbow	17-2471	DSF Skimmer Front Plate Gasket	G-3112	Pac Fab	35-3506	460-650 Pump Gasket
G-3003	Hayward	SPX0097-E	Skimmer Gasket	G-3114	Purex	—	Eastside Pump Gasket
	Hayward	SPX1097-E	Skimmer Gasket	G-3115	Sta Rite	—	VB35-1 Submersible Pump Gasket
G-3004	Muskin	54018	A-4372 & A-4372F Skimmer Gasket	G-3116	Peerless	—	4 Hole Bracket to Pot Gasket
	Muskin	A-4372	Skimmer Gasket	G-3117	Pac Fab	—	Hydro 540 Pump Gasket
	Muskin	A-4372F	Skimmer Gasket		Pac Fab	35-3502	540 Pump Gasket
G-3006	Hayward	SPX1090-E	Vinyl Skimmer Gasket-Fiber	G-3118	Sears	—	Sprinkler Gasket
	Muskin	098-7235	Skimmer Gasket-Fiber		Sta Rite	C20-086	Sears Sprinkler Gasket
G-3006K	Aqua Lead.	—	Skimmer Gasket Kit-2 Sets	G-3119	Sta Rite	—	D Series Pump Gasket
			Totaling 4 Gaskets		Sta Rite	—	D Series Pump Gasket
	Olympic	ACM-83	Gasket Set	G-3120	Luitweiler	—	New Style Pump Gasket
G-3008	American	850077	W/T Skimmer Sealing Gasket	G-3121	Pac Fab	35-3513	880-881 Pot to Volute Gasket
	Pac Fab	51-6231	Bermuda Skimmer Gasket	G-3122	Muskin	54012	5 Position Valve Gasket
G-3009	American	850034	Front Gasket For Front Access Skimmer	G-3123	Sta Rite	C20-087	Well & Irrigation Pump Gasket
G-3010	Baker Hyd	51B1047	Skimmer Face Ring Gasket (For Kit Order 2)	G-3124	Hayward	SPX1058-D	Main Drain Gasket
G-3011	American	850033	Rear Gasket For Front Access Skimmer	G-3125	Baker Hyd	35B1136	Spa Pak Pump Housing Gasket
G-3012	Jacuzzi	13-0411-08	Face Plate Gasket For Wide Mouth Skimmer		Hayward	SPX1500-H	Pump Gasket-Fiber
G-3014	Hayward	SPX1084-B-3	SP-1084-OM Gasket	G-3126	Purex	—	Eastside Old Style 6 Hole Pot to Volute Gasket
G-3016	Hayward	SPX0084-M	Skimmer Gasket	G-3127	Hydropump	—	650 Pump Gasket
G-3017	Hayward	CX2500-5-B-1	Gasket		Pac Fab	—	Hydro 650 Model Pump Gasket
G-3018	Hayward	SPX0090-E	Skimmer Gasket	G-3128	Hayward	SPX1250-G	Pump & Mounting Bracket Gasket
G-3019	Hayward	SPX0099-E	Skimmer Gasket	G-3129	Sta Rite	J20-009	Well & Irrigation Pump Gasket
G-3020	Hayward	SPX1084-B	Skimmer Gasket	G-3130	Purex	—	Eastside Old Style 8 Hole Pot to Volute Gasket
	Pac Fab	55-2566	Skimmer Gasket	G-3131	Hayward	SPX0058-D	Main Drain Gasket
G-3021	Jacuzzi	13-0878-04	Flange Gasket	G-3132	Hayward	SPX0505-G	Shell Assembly Gasket
G-3022	Jacuzzi	94-1104-67	SV Basic Skimmer Face Gasket	G-3133	Flint & Wall	—	Sprinkler Pump Gasket
	Muskin	54015	Skimmer Face Plate Gasket	G-3134	Pac Fab	—	Hydro VB-40 Volute Gasket
G-3023	Sta Rite	C20-035	Delrin Plastic Volute Gasket	G-3135	Hydropump	—	560-700 Series Gasket
G-3024	Marlow	—	34 EC-15D Tank Cover Gasket		Pac Fab	—	Hydro 560-700 Series Gasket
G-3025	Laars	E-376	Heater Gasket	G-3136	Flint & Wall	—	Pump Jet Gasket
G-3026	Hayward	SPX1099-E	SP-1099S Skimmer Gasket		Sta Rite	J20-011	Well & Irrigation Pump Gasket
	Jacuzzi	13-0462-06	SV, SL Skimmer Gasket	G-3137	Hayward	SPX1039-C-2	Fitting Gasket (For Kit Order 2)
	Waterway	806-1070	Square Skimfilter Gasket	G-3138	Jacuzzi	13-0273-05	4 Way Valve Gasket
G-3027	Cascade	500010	Aqua Genie Faceplate Gasket-Fiber	G-3139	Anthony	—	Pump Gasket
G-3028	Chemtech	27911	Series 200 Motor Housing Gasket		Purex	—	Eastside Old Style Volute Gasket
G-3029	Waterway	806-1040	Skim Filter Gasket	G-3140	Hydropump	—	Pump Sweep Motor Gasket
G-3030	Acura	0390	Power Quip Heater Gasket		Pac Fab	—	Hydro Pump Sweep Motor Gasket
G-3031	Sylvan	59200236	Old Style Vinyl Skimmer Gasket	G-3141	American	453330	Pep Main Drain Gasket
G-3032	Sta Rite	U9-366	U3 Auto Skimmer Gasket	G-3143	Lomart	043-013	Body Gasket
G-3034	American	850016	Liner Gasket-Fiber (For Kit Order 2)	G-3144	Ampro	—	Selector Valve Gasket-4 3/8" OD
G-3035	Muskin	54024	Mini Skimmer Gasket	G-3145	Muskin	54014	Discharge Fitting Gasket
G-3036	Rainbow	17-2470	DSF Skimmer Rear Gasket	G-3146	American	792046	Spa Light Sealing Gasket (For Kit Order 3)
G-3037	Equator	19-0159-2	Face Plate Gasket	G-3147	Purex	—	Eastside Seal Well Gasket
G-3038	Jacuzzi	13-0007-08	Standard Throat Gasket	G-3148	American	510049	2" B/V Cap Gasket
G-3039	Baker Hyd	51B1047	Hydro-Pak Face Ring Gasket		Premier	21-391	2" Cap Gasket
G-3101	Luitweiler	—	Old Style Pump Gasket	G-3149	American	871020	Drain Pump Gasket
G-3102	Luitweiler	—	Large 4 Hole Gasket	G-3150	Muskin	54011	Self Priming Pump Housing Gasket
G-3103	Marlow	21034	Tank to Lantern Gasket	G-3151	Aqua Flo	91500000	AC Series Volute Gasket
G-3104	Monarch	—	Pump Gasket		Aqua Flo	ACF-11/915	Commercial Volute Gasket
G-3105	Marlow	—	2112 8-Hole Large Cover Gasket		Sta Rite	C20-021	Pump Gasket
	Marlow	2112	Large 8 Hole Cover Gasket	G-3152	Luitweiler	—	Small 4 Hole Gasket
G-3106	Marlow	—	34EC-15D Tank Gasket	G-3153	Jacuzzi	13-1223-04	Gasket
G-3107	Pac Fab	35-3501	Hydro B/V Pump Gasket	G-3154	Jacuzzi	13-0243-02	Gyromat Valve Gasket
G-3108	Luitweiler	—	Pump Volute Gasket				

GASKETS-LISTED IN SSC# ORDER

SSC#	FITS OEM	FITS OEM#	DESCRIPTION	SSC#	FITS OEM	FITS OEM#	DESCRIPTION
G-3155	Pac Fab	67-0018	Spa Vinyl Niche Gasket	G-3210	Anthony	04466	Sweep Pump Gasket 105, VB44
G-3157	American Purex	792003 71446	Niche Gasket (For Kit Order 2) Old Style Vinyl Niche Gasket	G-3211	Peerless	—	2 Hole Pot to Volute Gasket
G-3158	American	792004	Standard Hole Niche Gasket (For Kit Order 3)	G-3212	Doughboy	307-1004	Cartridge Gasket
G-3159	Hydropump	VB40	Volute Gasket	G-3214	Filter Flow	—	Body Gasket
G-3160	Hydropump	VB2	Volute Gasket-200 Series VB2	G-3215	Hayward	SPX0508-B-A	Cover Gasket Only
G-3161	Hydropump	400	Pot to Volute Gasket	G-3216	Jacuzzi	13-0061-01	Pump Gasket
G-3162	Sta Rite	C20-009	Pump Gasket	G-3217	Jacuzzi	13-0150-02	VB-21 Gasket
G-3163	Pac Fab	63-4568	Vinyl Pool Niche Gasket	G-3218	Gen. Major	13-0277-01	4 Way Valve Gasket
G-3164	Sta Rite	C20-046	Pump Gasket	G-3219	Hayward	—	Body Gasket
G-3165	Hayward	SPX0506-D	Niche Gasket	G-3220	Aqua Flo	SPX0125-H	Pump Gasket
G-3166	Hayward Marlow	SPX0125-G 23112	Pump Gasket H Series Pump Housing Gasket	G-3220	Aqua Flo	91500100	A Series 3 HP Volute Gasket
G-3168	Hayward	SPX0145-G	Pump Gasket	G-3220	Aqua Flo	AF-11-01	3 HP Volute Gasket
G-3169	Anthony	VB27	Volute Pump Gasket	G-3220	Premier	35-271	Bracket to Volute Gasket
G-3170	Hayward	SPX1048-D	Main Drain Vinyl Gasket-Fiber	G-3220	Premier	39-271	Bronze Pump Gasket
G-3171	Jacuzzi	13-0463-05	SL Skimmer Suction Fitting Gasket	G-3220	Purex	72999	Guardex Washer-Fiber
G-3171	Jacuzzi	13-0888-02	5-Way Valve Gasket	G-3222	Sta Rite	VB43	Pump Gasket
G-3172	Jacuzzi	13-0192-03	Gasket	G-3224	Marlow	26588	Discharge Gasket
G-3173	Hayward	SPX0409-C-2	Fitting Gasket (For Kit Order 2)	G-3225	Muskin	038-3432	Viewport Gasket
G-3174	Marlow	—	34EC-15D Pump Inlet Gasket	G-3226	Anthony	04465	AJ 105 Sweep Pump Gasket
G-3175	Purex	70952	Air Relief Fitting Gasket	G-3226	Sta Rite	C20-079	AJ Series Gasket
G-3176	Jacuzzi	13-0191-04	Gasket	G-3228	Sta Rite	16800-11	Pump Gasket
G-3177	Pac Fab	35-3500	Hydro Pot to Volute Gasket-Fiber	G-3228	Sta Rite	16800-29	XLVI Old Style Gasket
G-3178	Hydropump Pac Fab	— —	400 Pot to Volute Gasket Hydro 400 Model Pot to Volute Gasket	G-3229	Sta Rite	N20-039	Pump Gasket
G-3180	Lomart	042-024	Body Gasket	G-3230	Muskin	54009	Viewport Gasket
G-3181	Martec	420-512	Eyeball Teflon Piece	G-3231	Muskin	101-6910	Vinyl Washer
G-3182	Jacuzzi	—	Filter Gasket	G-3232	Muskin	038-3439	Jet Stream Tank Gasket
G-3183	Rainbow	172541	Dynamic Lock Gasket	G-3233	Sta Rite	N20-025	Gasket
G-3184	Chemtech	27903	Series 100/200 Gasket	G-3234	Pac Fab	27-3004	Screw Type Valve Cap Gasket
G-3185	Hayward	GMX0400-D	GM-400 Multiport Gasket	G-3235	Laars	—	Round By-Pass Gasket
G-3186	Chemtech	42031	Series 200 Gasket-Fiber	G-3235	Muskin	54007	Tank to Valve Inside Washer
G-3187	Waterway	—	Large (Outside) Gasket For Jet on Medallion Pool	G-3236	Sta Rite	N20-026	Pump Gasket
G-3188	Waterway	—	Small (Inside) Gasket For Jet on Medallion Pool	G-3237	Arneson	G-29B	Gear Housing Gasket
G-3189	Ester Will.	—	Port Hole Gasket-Above Ground	G-3238	Arneson	G-29	Gear Housing Gasket
G-3190	Muskin	54023	Thru Wall Return Gasket	G-3239	American	570087	Olympian Filter Fiber Washer
G-3191	Muskin	54020	Backwash Valve Cap & Pos. Valve Gasket	G-3240	Aqua Flo	91500200	A Series 6" & 8" Trap Gasket
G-3192	Muskin	54016	Backwash Valve Outside Tank Gasket	G-3240	Aqua Flo	AF-12-1	3 HP Trap Gasket
G-3193	Muskin	54005	FP Pump, Drain Fitting Gasket	G-3240	Premier	32-248	Bronze Strainer to Volute Gasket
G-3194	Muskin	54006	Air Relief Bushing Gasket	G-3240	Premier	33-248	Pot to Volute Gasket
G-3195	Muskin	54021	Mylar Resin Tank Gasket	G-3241	Sta Rite	C20-019	Dura Glass Pump Gasket
G-3196	Muskin	54022	Resin Tank Gasket	G-3241	Pac Fab	35-3512	880-881 Pot Flange Gasket
G-3197	Sta Rite	C20-101	CC Seal Gasket	G-3241	Sta Rite	C20-103	Duraglass Pump Gasket-Fiber
G-3198	Jacuzzi	13-0877-05	Gasket	G-3242	Hayward	SPX1023-Z-3	Inlet/Outlet Washer Gasket-Fiber
G-3199	Sta Rite	C20-100	CC Gasket	G-3243	Purex	P-10675	VF30 Gasket
G-3202	Jacuzzi	13-0314-06	Pump Gasket-Fiber	G-3245	Laars	E-325	Heater Gasket
G-3203	Ampro	646	Pump Gasket	G-3246	Raypak	800004	1 1/2" Unitherm Governor Gasket
G-3204	South Seas	—	Outlet Heater Gasket	G-3247	Purex	70941	Uniseal & L Series Bracket to Volute Pump Gasket
G-3205	Diaclear	C-46251	MS 18 Pump Gasket	G-3248	Purex	—	Eastside 2 Hole Pot to Volute Gasket
G-3206	Swimrite	36-828-266	Pool Control Gasket	G-3249	H & F	—	Volute Gasket-Thin
G-3207	H & F	—	Pot to Volute Gasket	G-3249	Sta Rite	C20-072	Thin Pump Gasket
G-3207	Hydropump	511	Pot to Volute Gasket VB20	G-3250	Ampro	6-146	Gasket
G-3207	Hydropump	VB20	511 Pot to Volute Gasket	G-3251	Aquarius	—	Volute Gasket
G-3207	Wet Inst.	34-050-309	Trap to Volute Gasket	G-3252	Laars	E-516	Thermostat Cover Gasket
G-3208	Sta Rite	G20-012	Well & Irrigation Pump Gasket	G-3252	Anthony	04382	AC, AS Volute Gasket
G-3208	Sta Rite	J20-012	Well & Irrigation Pump Gasket	G-3253	Purex	P-10630	BT Series Backwash Valve Pump Gasket
G-3209	Lomart	040-024	Body Gasket	G-3254	International	—	Bonnet Flange Gasket
				G-3255	Purex	70940	Pot to Volute L Series Pump Gasket
				G-3256	Aqua Flo	91500050	A Series 1/3 to 2 HP Volute Gasket, B Series Gasket
					Aqua Flo	AF-11	Volute Gasket
					H & F	—	Volute Gasket
					Premier	31-276	1/2-2 HP Volute Gasket
					Sta Rite	C20-072	Thick Pump Gasket

GASKETS-LISTED IN SSC# ORDER

SSC#	FITS OEM	FITS OEM#	DESCRIPTION	SSC#	FITS OEM	FITS OEM#	DESCRIPTION
	Swimrite	60-828-276	Backwash Valve Pump Gasket	G-4007	Comfortzn.	GKT-7401	Large Bucket Gasket (For Kit also Order G-4018)
G-3257	Peerless	—	Bracket to Pot Round Gasket	G-4008	American	850016	Liner Gasket-Rubber (For Kit Order 2)
G-3258	Sta Rite	C20-102	ACP Pump Seal Plate Gasket		Sta Rite	8653-7	Skimmer Gasket
G-3259	Sta Rite	CN20-035	Pump Gasket	G-4011	South Seas	VB11	Inlet Heater Gasket
	Sta Rite	N20-035	Pump Gasket	G-4012	Sta Rite	8652-5	U-3 Skimmer Face Plate Gasket
G-3261	Sta Rite	C20-077	C & CC Series Pump Gasket	G-4014	Muskin	038-3458	Skimmer Gasket
G-3262	Hayward	SPX1025-Z-3	SP-1025 Filter Slip Washer	G-4015	Pac Fab	19-5004	Poly Gasket
	Hayward	SPX1035-C	SP-1035 AV Main Drain Fiber Sealing Slip Gasket Washer	G-4016	Laars	—	2 Button Command Center Face Plate Gasket
G-3263	Pac Fab	—	Washer		Len Gordon	—	Face Plate Gasket
G-3264	Doughboy	310-1039	Tube to Spin-O-Cycle Gasket	G-4017	Laars	S-245	Heater Gasket
	Lomart	053-047	Gasket	G-4018	Comfortzn.	GKT-7402	Small Bucket Gasket (For Kit Also Order G-4007)
G-3265	Raypak	800007	2" Unitherm Gasket	G-4019	Swimrite	36-828-136	Mixing Box Heater Gasket
G-3266	Marlow	—	VP-153 Strainer Body Gasket		Swimrite	36-828-146	Mixing Box Cover Gasket
	Marlow	VP-153	Strainer Body Gasket	G-4020	Laars	S-248	Heater Gasket
G-3268	Hayward	SPX1500-X	Pump Gasket	G-4021	Comfortzn.	GKT-1930	CZ/HMZ Gasket
G-3269	Muskin	54017	Valve Cover Gasket	G-4023	South Seas	VB12	Outlet Heater Gasket
G-3271	Pac Fab	27-3097	Brass Backwash Valve Cap Gasket	G-4024	Laars	S-246	Heater Gasket
				G-4025	Anthony	15981	Inlet/Outlet Heater Gasket
G-3273	Muskin	037-3408	Drain Cap Gasket	G-4026	Coleco	30483	Hydro Skim Gasket
G-3274	Laars	E-327	Heater Gasket	G-4027	Laars	S-055	Heater Gasket
G-3275	Aqua Flo	91500150	A Series 5" Trap Gasket	G-4029	Doughboy	307-1027	Skim-Line Face Plate Gasket
	Aqua Flo	AF-12	Trap Gasket	G-4029A	Doughboy	307-1027	New Style Skimmer Gasket-Wider
	Premier	VB38	Volute Gasket				
	Swimrite	60-828-274	P/V Pump Gasket	G-4030	Doughboy	307-1005	MY205 Skimmer Gasket (For Kit Order 2)
G-3277	American	501407	1 1/2" Multiport Valve T/M Series Gasket	G-4031	Pac Fab	51-3033	Skimmer Gasket
	Hayward	SPX0710-Z-1	Non-Metallic Bearing Gasket	G-4032	Aqua Lead.	—	Skimmer Face Plate Gasket
	Hayward	SPX0710-Z-14	Non-Metallic Bearing Gasket	G-4033	Martec	320-108	Flange Gasket
	Hayward	SPX0710-Z-16	Non-Metallic Bearing Gasket	G-4034	Cascade	500010	Aqua Genie Faceplate Gasket-Rubber
G-3278	Doughboy	307-1003	Cartridge Gasket	G-4035	Cascade	500011	Aqua Genie Oriface Gasket
G-3280	Laars	F-111	Heater Gasket	G-4036	Martec	610-112	FAS Skim Filter Gasket
G-3281	Doughboy	327-1007	Friction Washer	G-4037	Laars	S-700	Temp Control Gasket
G-3282	Diaclear	035-3400	HPE Diaclear Gasket	G-4038	King	01-22-7850	King Tech Scoop Gasket
G-3283	Bilnor	1743	Skimmer Gasket		King	01227856	Scoop Gasket
G-3284	Sta Rite	42001-0066S	Ignitor Gasket		King	01-22-7856	Scoop Gasket
G-3400	Pac Fab	55-2471	Liner Sealing Rim Gasket	G-4040	Acura	0163	Turbo Blower Cover Gasket
G-3401	Sta Rite	07017-0079	Drain Gasket	G-4041	Hayward	SPX1094-G	Skimmer Gasket-Rubber
G-3402	Olympic	ACM-97G	Main Drain Gasket	G-4042	Doughboy	308-1089	DIX Skimmer Gasket
G-3403	Muskin	54055	Tank Gasket		Lomart	308-1089	DIX Skimmer Gasket
G-3404	Marlow	P48690	L Stockline Pump Volute Gasket	G-4043	Coleco	38213	Skimmer Gasket
					Doughboy	308-1068	S-12, 60-4012 Skimmer Gasket
G-3405	Muskin	54076	Poly Element Filter Gasket		Lomart	308-1068	S-12, 60-4012 Skimmer Gasket
G-3406	Jacuzzi	13-0011-02	2" Plug Gasket	G-4044	Sundance	6560-045	Hi Flo Heater Box Gasket
G-3407	Jacuzzi	13-0013-00	1 1/2" Plug Gasket	G-4045	Sundance	6560-046	Hi Flo Heater Element Gasket
G-3408	Sta Rite	33455-8043	Commercial Impeller to Shaft Washer	G-4046	Jacuzzi	01-0990-00	JWB Whirlpool Gasket
G-3409	Sta Rite	33455-8044	Commercial Impeller to Shaft Sleeve Gasket	G-4047	Hydro Air	16-5623	Verta'ssage Backing Plate Gasket
G-3410	Sta Rite	33450-8042	Commercial Volute Discharge Gasket				
G-3411	Sta Rite	33450-8041	Commercial Volute Suction Gasket	G-4048	Hydro Air	16-5004	Hydr'ssage Cannister Gasket
G-3412	Sta Rite	S04757	Commercial Volute to Bracket Gasket	G-4049	Astral	1461R0001	Skimmer Gasket
G-3414	Marlow	471210	4 SPC Gasket	G-4050	Sta Rite	0956-0150	Standard Skimmer Gasket
G-3415	Marlow	470400	4 SPC Gasket	G-4051	Clayton	P-4450	Face Plate Gasket
G-3416	Equator	19-0552-1	Main Drain Face Ring Gasket	G-4052	Jacuzzi	13-0014-09	Gasket
G-4001	Aqua Sports	SMS-1094G	Face Plate Gasket (for Kit Order 2)	G-4053	Waterway	711-4100	Wide Mouth Gasket
	Hayward	SPX1090-E	Vinyl Skimmer Gasket-Rubber	G-4054	Olympic	GAS-1096-G	Widemouth Gasket for ACM96 Skimmer
	Muskin	098-7235	Skimmer Gasket-Rubber				
	Season Mstr	SMS-1094G	Face Plate Gasket (for Kit Order 2)	G-4055	Astral	00273R0001	Gasket
G-4002	American	451170	Twin Port Skimmer Sealing Gasket		Hercules	1370097	Skimmer Gasket
G-4003	Edgewood	—	Inlet Heater Gasket	G-4056	Lochinvar	GKT-2400	Heat Shield Gasket
G-4004	Edgewood	—	Outlet Heater Gasket	G-4058	Olympic	WP-83W	Regular Gasket for Widemouth Skimmer
G-4005	Anthony	15147	Dual Housing Heater Gasket	G-4059	Olympic	ACM-83C	Rubber Skimmer Gasket (For Set Order 2)
G-4006	Anthony	—	Inlet/Outlet Gasket				

GASKETS-LISTED IN SSC# ORDER

SSC#	FITS OEM	FITS OEM#	DESCRIPTION	SSC#	FITS OEM	FITS OEM#	DESCRIPTION
G-4060	Sta Rite	0956-0152	Above Ground Skimmer Wide Mouth Gasket	G-4204	Sta Rite	WC20-02	Filter Gasket
G-4061	Muskin	54028	Skim Filter Body Gasket		Swimrite	30-828-911	Sight Glass Gasket
G-4062	Aquavac	78005	Tiger Shark Bottom Lid Gasket	G-4205	Regal	G-203	Chlorinator O-ring
G-4063	Jandy	2644	Valve Actuator Gasket		Sta Rite	P64-069	P/V Sight Glass Gasket
G-4102	Jacuzzi	13-0880-00	M/V Gasket	G-4206	Sta Rite	C69-002	Duraglass Pump Slinger Gasket
G-4103	Hayward	SPX0603-F	Cover Gasket		American	—	Rubber Washer
G-4104	Pac Fab	35-2627	Backwash Valve Gasket Replaces 35-3500	G-4207	Premier	21-108	Rubber Washer
G-4105	Sta Rite	WC20-16	Sand Filter Gasket		Premier	25-575	Neptune Sand Filter Gasket
G-4110	Hayward	SPX0577-Z-1	Deck Box Cover Gasket	G-4208	Swimrite	36-828-453	Washer
G-4111	Hayward	CX2500-3-Z-2	Gasket	G-4209	A.O. Smith	99659-1	Inlet Manifold Gasket
G-4112	Hayward	SPX0605-F	Cover Gasket	G-4210	Laars	—	Aqua Dye Round Gasket
G-4114	Coleco	30484	Return Fitting Gasket	G-4211	Laars	S-157	Heater Gasket
G-4115	Sta Rite	WC20-05	Filter Gasket	G-4212	Hayward	DEX2400-S-5	Micro Clear Filter Relief Valve Tank Gasket
G-4116	Hayward	SPX1048-D	Main Drain Vinyl Gasket-Rubber	G-4214	Capitol	G-106	Chlorinator Gasket
G-4119	Hayward	SPX1500-H	Pump Gasket-Rubber		Hayward	SPX0102-Z-32	Gasket
G-4120	American	390008	Power Pump Gasket	G-4215	Ampro	900-4	Upper Cap Washer
G-4121	Hayward	SPX0602-F	Gasket	G-4216	Baker Hyd	17B1085	Cartridge Filter Gasket
G-4122	Pac Fab	35-3500	Hydro Pot to Volute Gasket-Rubber	G-4217	Anthony	—	Oval Lid Gasket
G-4123	Purex	70943	C Series Pot to Volute Gasket	G-4218	Hayward	SPSTX0340-Z1	6" In Line Trap Cover Gasket
G-4124	Hayward	SPX1411-Z-12	Gasket for SP-1411, 1407-1		Muskin	54027	8" HMLI Tank Gasket
G-4125	Jacuzzi	13-0329-09	Gasket	G-4219	Doughboy	308-1145	Drain to Valve Gasket
G-4128	Misc	—	Light Deck Box Gasket		Lomart	053-133	Gasket
G-4129	Purex	P-11200	Flo Valve Gasket	G-4220	Doughboy	307-1023	Deluxe Skimmer 90 Degree Radius Fitting Gasket
G-4130	American	510004	Multiport Cover Gasket		Doughboy	308-1110	Gasket
G-4131	Doughboy	307-1002	MX60RP Inlet Fitting Gasket	G-4221	American	422160	Power Glass Gasket
G-4132	Bilnor	1750	Return Fitting Gasket	G-4222	Monarch	199696	Seal Gasket
G-4133	Bilnor	1761	Return Fitting Gasket	G-4223	Homelite	62363-A	Gasket
G-4134	Hayward	SPX1408-C	Vinyl Eyeball Gasket		Jacuzzi	13-0414-05	Cartridge Filter Tube Gasket
G-4136	Speck	2926999990	Sand/DE Filter Rim Gasket	G-4224	Anthony	15448	Rubber Tube Seal Gasket
G-4137	Acura	0167	Turbo Blower Motor Mount Gasket		South Seas	—	Small Rubber Gasket
G-4138	Speck	2303002002	Jet Gasket	G-4225	Wallace	37661	Chlorinator Gasket
G-4139	Speck	2301001013	Badujet/Stream Gasket	G-4226	Muskin	037-5071	Grid Post Gasket
G-4140	Speck	2302002060	Badujet IT Gasket		Wallace	44122	Chlorinator Gasket
G-4141	Jacuzzi	13-0006-09	Vinyl Return Fitting Gasket	G-4227	Baker Hyd	35B1116	Spa Pak Pump Slinger Gasket
G-4142	Hydro Air	16-5523	Thera'ssage Gasket		Hayward	SPX0125-F	Motor Shaft Slinger Gasket
G-4143	Astral	02064	Sand Filter Gasket	G-4228	Misc	—	2" Fire Hose Gasket
G-4144	Astral	545R0305	Bulkhead Gasket	G-4229	Buster Cr.	20-1040	Pump Gasket
G-4145	Astral	365R0002	Light Gasket		C & R	20-1040	Pump Gasket
G-4146	Astral	687R0303	Sand Filter Gasket		Hayward	SPX1438-J	Pro Jet Gasket
G-4147	Astral	271R0002	Main Drain Gasket	G-4230	Jacuzzi	13-0300-02	Flange Gasket
G-4148	Sta Rite	05057-0667	Light Niche Gasket	G-4231	Baker Hyd	284860	Old Spa Pak Pump Slinger Gasket
G-4149	Purex	70935	Cover Gasket		Marlow	28484	AF Series Pump Slinger Gasket-All Models
G-4150	Astral	788R4140120	Gasket	G-4232	Regal	G-204	Chlorinator Gasket
G-4151	Jacuzzi	13-1207-04	Main Drain Gasket	G-4233	Paddock	—	1 1/4" - 1 1/2" Flat Gasket
G-4152	Jacuzzi	13-0864-00	Main Drain Gasket	G-4234	Homelite	62665-A	Impeller Housing Gasket
G-4153	Astral	02063	Gasket	G-4237	American	—	Olympian Filter Gasket
G-4154	Astral	02065	4" Gasket		American	510137	Bulkhd Gsk-Titan, Sandpiper 18&24, Carbide, Quantum
G-4155	Astral	02068	6" Gasket		Misc	—	3" Discharge Hose Flat Washer
G-4156	Astral	00690R0402	Sand Filter Drain Gasket		Misc	—	3" Fire Hose Gasket
G-4157	Astral	00546R0202	Interior Bulkhead Gasket	G-4238	Marine	3660	Flat Rubber Gasket
G-4158	Astral	00270R0001	Gasket	G-4239	Sta Rite	WC20-15	Sand Filter Gasket
G-4159	Sta Rite	05161-0006	Niche ABS Liner Gasket	G-4240	Misc	—	Fire Hose Coupling Gasket
G-4160	American	872063	Aqua Lumin Sealing Gasket	G-4241	American	791143	Fun Light Gasket
	Doughboy	—	New Main Drain Gasket		Doughboy	308-1147	Viewport Gasket
G-4161	Doughboy	308-1172	Main Drain Gasket		Lomart	053-140	Viewport Gasket
G-4162	Arneson	AXL12	Main Drain Gasket	G-4242	South Seas	—	Bypass Gasket
G-4163	American	467220	Aqua Fan Gasket	G-4243	Hayward	SPX1035-B	SP-1035 AV Main Drain Gasket
G-4164	Purex	70947	Sunlite Niche Face Ring Gasket	G-4244	Hydro Air	10-3804	Wall Fitting Gasket
G-4186	Jacuzzi	13-0314-06	Pump Gasket-Rubber		Waterway	711-6020	2 1/2" Heater Union Gasket
G-4201	Doughboy	308-1081	Valve Cap Gasket	G-4245	Purex	P-11125	Tropic Inlet/Outlet Heater Gasket
	Lomart	053-157	Gasket	G-4246	Raypak	800164	Element Gasket
G-4202	Doughboy	308-1083	Gasket				
G-4203	Jacuzzi	13-0244-01	Filter Gasket				

GASKETS-LISTED IN SSC# ORDER

SSC#	FITS OEM	FITS OEM#	DESCRIPTION	SSC#	FITS OEM	FITS OEM#	DESCRIPTION
G-4247	Purex	70943	Flange Gasket	G-4290	American	461130	2" ID Thick Gasket
G-4248	Paddock	—	2" Flat H&L Gasket		American	872002	Thin Line Spa Skimmer Gasket
G-4249	Hayward	SPX1434-L	Jet Air III Gasket		American	872012	2" ID Thick Gasket
G-4250	Doughboy	308-1076	Gasket		Hayward	SPX1023-Z-12	Return Fitting Gasket
G-4251	Swimrite	28-828-325	Washer		Season Mst	SMS-1023G	Skimmer Wall Fitting Gasket (For Kit Order 2)
G-4252	Jacuzzi	13-0275-03	4-Way Valve Gasket	G-4291	Pac Fab	19-2032	Gasket
G-4253	Slinger	—	Water Slinger-1 1/4" OD x 11/32" ID	G-4292	Premier	29-869	Rubber Washer
	Sta Rite	C69-002	Water Slinger Gasket (Replaces N69-001)	G-4294	Muskin	54010	Viewport Gasket
	Sta Rite	N69-001	Water Slinger Gasket (C69-002 Replaces This)	G-4295	Astral	00545R0214	Gasket
G-4254	Paddock	—	Trimmer Lid Keyhole Gasket		Coleco	34027	Gauge Gasket
G-4255	South Seas	—	Large Rubber Gasket	G-4296	Pac Fab	15-4539	1 1/2" Super Flow B/H Gasket
G-4256	Slinger	—	Water Slinger-1 3/4" OD x 13/16" ID	G-4297	American	791048	Rubber Washer
	Sta Rite	C69-012	C Pump Water Slinger Gasket	G-4298	American	530004	Shaft Sleeve Gasket
G-4257	Astral	103R0003	Drain Gasket		Marine	—	DE Spin Filter Shaft Sleeve Gasket
G-4258	Jacuzzi	13-0872-06	Valve Gasket	G-4299	Hayward	SPX1025-Z-1	Return Fitting Gasket
G-4259	Hayward	SPX1025-Z-12	SP-1025 Gasket (For Kit Order 2)	G-4300	American	510018	Multiport Valve Rubber Gasket (For Kit Order 2)
G-4260	Hayward	SPX1432-E	Jet Air Mini Jet Gasket		American	510087	Rubber Sight Glass Washer
G-4261	Hayward	SPX0072-C-2	Gasket	G-4303	Laars	225	3/16" Thick Washer
G-4262	Laars	S-151	Heater Gasket		Laars	S-057P	Aqua Dyne 3/16" Thick Washer
G-4263	Doughboy	348-1033	Slinger Washer	G-4304	Laars	S-156	Heater Gasket
	Lomart	046-029	Gasket	G-4305	Doughboy	307-1007	Skim Filter Drain Cap Gasket
	Slinger	—	Water Slinger-1 5/32" OD x 7/16" ID	G-4306	Hayward	SPX1072-4-2	Gasket
G-4264	Hayward	SPSTX0345-H	8" In Line Trap Cover Gasket	G-4309	Coleco	34023	Gasket
G-4265	Jacuzzi	47-0222-07	PM Filter Valve Gasket		Doughboy	308-1109	Silica Valve Body Gasket/Washer
	Pac Fab	19-2404	SCS Return Sleeve Gasket		Lomart	053-029	Valve to Tank Gasket
G-4266	Purex	70942	Tropic Inlet/Outlet Gasket For All Models	G-4310	American	510061	Sight Glass Gasket
G-4267	American	510065	Air Relief Valve Sep. Tank Gasket		Anthony	—	Sight Glass Gasket
	Hayward	SPX1700-FG	Washer		Premier	SG-364	Sight Glass Gasket
G-4268	Baker Hyd	31B0015	Baker Valve Top Plate Gasket	G-4311	American	550009	Sandpiper Hub Gasket
	Purex	70152	Index Plate BH Valve Gasket	G-4312	Regal	G-202	Chlorinator Gasket (For Kit Order 2)
G-4269	Hayward	SPSTX0330-Z1	4" In Line Trap Cover Gasket	G-4314	Raypak	800014B	Gemini Tube Seal Gasket
G-4270	Hayward	SPSTX0335-Z1	5" In Line Trap Cover Gasket	G-4315	Laars	—	Large Tube Round Gasket
G-4271	Baker Hyd	31B9006	Sand Filter Bulkhead Fitting Gasket		Laars	S-056	Large Tube Round Gasket
	Purex	70169	Bulkhead Gasket	G-4316	Laars	—	Washer
G-4272	Hayward	SPSTX0325-F	3" In Line Trap Cover Gasket		Laars	S-056P	Aqua Dyne Heater Washer
G-4273	Hayward	SPSTX0315-Z1	2" In Line Trap Cover Gasket	G-4319	American	510054	6 Position Valve Sight Glass Gasket
G-4274	Sta Rite	2PLL	Light Lens Gasket		Astral	00541R0402	Persius Sand Filter Drain Gasket
G-4275	Swimrite	36-828-280	Washer		Hydrotech	B154	Brominator Air Vent Gasket
G-4276	Doughboy	308-1146	Viewport Lid Gasket	G-4320	Astral	00612R0001	Filter Gasket
	Lomart	053-120	Viewport Lid Gasket		Swimrite	14-828-381	Block Hose Washer
G-4277	Marlow	—	AF Pump Cover Gasket (All Models)		Swimrite	36-828-114	Heater Gasket
G-4278	American	510136	Bulkhead Gasket	G-4322	Marine	1220	Flat Rubber Bushing Gasket
G-4279	Rainbow	17-2015	Lifeguard Cartridge Filter Gasket		Premier	122	Rubber Washer
G-4280	Hayward	SPX0710-R	Multiport Valve Sight Glass Gasket	G-4323	Muskin	038-3416	Tank Tube Valve Gasket
G-4281	Muskin	037-5002	Air Relief Valve Assembly Gasket	G-4324	Doughboy	308-1139	Flat Cut Gasket
G-4282	Pac Fab	19-2031	Crankshaft Sleeve Flat Gasket		Lomart	053-211	Gasket
G-4283	Premier	27-379	Hercules Filter Lid Gasket		Pac Fab	15-4538	2" Bulkhead Fitting Gasket
G-4284	American	392048	Eagle Gasket	G-4325	Hayward	SX0200-Z-9	Sand Filter Drain Gasket
G-4285	American	395001	Noryl Pump Slinger Gasket	G-4326	Anthony	27111	Large Tube Seal Gasket
	Purex	72187	Eastside Pump Water Slinger Gasket		Laars	—	Small Tube Round Gasket
	Slinger	—	Water Slinger-1 1/4" OD x 5/8" ID	G-4327	Anthony	12388	SS Ditron Upright Filter Air Release Valve Gasket
G-4286	Laars	S-159	Heater Gasket		Bio Lab	5470	Tygon Washer
G-4287	Paddock	—	3/4" Sight Glass Gasket		E-Z Chlor	12690-26	Saddle Fitting Gasket
G-4288	Muskin	038-3424	Tank Gasket	G-4328	Rainbow	17-2033	Tube Fitting Gasket
					Hayward	SPX0071-C-2	Sight Glass Gasket (For Kit Order 2)
					Muskin	038-3457	Valve Body Gasket-Flat

GASKETS-LISTED IN SSC# ORDER

SSC#	FITS OEM	FITS OEM#	DESCRIPTION	SSC#	FITS OEM	FITS OEM#	DESCRIPTION
G-4329	American Purex Swimrite	374058 70951 36-828-122	Heater Gasket Tube Seal Gasket Tube Heater Gasket	G-4397	Brett	63-0001	Current Collection Gasket
G-4330	American	910043	Rubber Washer	G-4398	Pac Fab	07-0951	Tube Seal Gasket
G-4331	Muskin	038-3421	Spin Filter Gasket	G-4399	Jacuzzi	13-1021-08	Fitting Gasket
G-4332	Hayward	SPSTX0305-F	1 1/2" In Line Trap Cover Gasket	G-4401	Baracuda	ADG-5	Universal Pool Cleaner Floor Gasket
G-4333	American	982085	Washer		Jandy	4487	Vac Floor Gasket
G-4334	Harmsco	639	Cover Gasket		Kreepy	12866	Universal Pool Cleaner Floor Gasket
G-4335	A.O. Smith	99659	Outlet Manifold Gasket	G-4402	Harmsco	635	15 Hole Cover Gasket
G-4336	Sta Rite	WC20-11	Filter Gasket	G-4403	Harmsco	636	15 Hole Cover Gasket
G-4337	Rainbow	17-2222	Cartridge Gasket	G-4404	Harmsco	671	27 Hole Cover Gasket
G-4338	Onyx	ON15	1 1/2" Spa Union Gasket	G-4405	Coleco	—	Hydro Gasket
G-4339	Onyx	ON20	2" Spa Union Gasket		Coleco	37280	Hydro Skimmer Float Gasket
G-4340	Laars	S-737	Tank Cover Gasket	G-4406	Sta Rite	PS20-011	Top Plate Gasket
G-4341	Martec	420-509	BJ 5000 Gasket		Sta Rite	PS20-018	Pump Gasket
G-4342	Speck	2301002025	Badujet/Stream Gasket	G-4407	Aqua Flo	91500250	A Series Drain Gasket
G-4343	Hydro Air	10-5847	Mark II Jet Assembly Gasket		Aqua Flo	FF-12-02	100% Drain Gasket
G-4344	Brett	61-0001	EM 103 Heater and Pump Gasket	G-4408	Raypak	800204	Bypass Gasket
G-4345	Ampro	641-36	Dura Flo Pump Gasket	G-4409	American	395012	Pot to Volute Pump Gasket
G-4346	Raypak	800086	155B Versa Gasket	G-4410	Jacuzzi	13-0178-01	U Pump Gasket
G-4347	Waterway	711-5000	Filter Niche Gasket	G-4411	Sta Rite	C20-103	Duraglass Pump Gasket- Rubber (Larger Bolt Holes)
G-4348	Ampro	512	AP900 P/PI Valve Gasket	G-4412	Sta Rite	C20-031B	LT Series Seal Plate Gasket
G-4349	Waterway	711-1290	Bath Jet Gasket	G-4414	South Seas	—	Inlet Bypass Gasket
G-4350	American	461352	Lux Spa Jet Gasket	G-4415	Muskin	038-3410	Drain Cap Washer
G-4352	Martec	400-102	DS Filter, JM Jet Gasket	G-4416	Purex	P-11250	Valve Gasket
G-4353	Martec	410-506	Bath Jet Gasket	G-4417	Wallace	40336	Chlorinator Gasket
G-4354	Waterway	711-4750	Polyjet Gasket	G-4418	Marine	1160	Bushing Cup Gasket
G-4355	Waterway	711-1760	Bath Jet Gasket		Muskin	54003	Valve Waste Cap Gasket
G-4356	Waterway	711-4500	Power Jet Gasket	G-4419	Swimrite	28-828-324	Bracket Mounting Gasket
G-4357	Raypak	800276	WHG 55A Gasket	G-4420	Raypak	800075	Heater Gasket
G-4358	Hydro Quip	61-0011	1 1/2" Heater Union Gasket	G-4421	Premier	23-256	Rubber Disc
	Waterway	711-4000	1 1/2" Union Gasket	G-4422	Hayward	SPX1500-RA-1	Pump Check Valve Gasket
G-4359	Waterway	711-4010	2" Heater Tailpiece Gasket	G-4423	Taylor	—	Aqualite PL-89 1603 Gasket
G-4360	Richardson	—	Thick Sand Filter Gasket	G-4424	Muskin	038-3457	1 1/2" Backwash Cap Gasket- Solid
G-4361	Richardson	—	Thin Sand Filter Gasket	G-4425	Doughboy	307-1001	Gasket
G-4362	Pac Fab	27-1106	Mounting Valve Sight Glass Gasket		Doughboy	308-1072	Gasket
G-4363	Sylvan	59201200	Throttling Plug Gasket	G-4426	Sta Rite	J20-016	Well & Irrigation Pump Gasket
G-4364	Waterway	711-1750	Polyjet Standard Gasket	G-4427	Jacuzzi	13-0239-08	5-Way Valve Gasket
G-4366	Hydro Air	10-3705	Air Control Valve Gasket	G-4428	Guardex	P72999	Rubber Washer
G-4369	Jacuzzi	13-1020-09	HT & WHJ Jet Gasket, Valve Gasket		Purex	72999	Guardex Washer-Rubber
G-4370	Hydro Air	10-2204	Air Control Valve Gasket	G-4430	Purex	70944	Valve Gasket
G-4371	American	501133	Bulkhead Gasket	G-4431	Anthony	15029	Old Style Rear Header Gasket
	American	510133	Bulkhead Gasket	G-4432	Raypak	800187	Heater Gasket
G-4373	Lomart	307-1023	DIX Skimmer Return Gasket	G-4433	Jacuzzi	13-0136-02	Flange Gasket
G-4374	American	711001	Mini Jet Wall Fitting Gasket	G-4434	Jacuzzi	13-0090-06	Pump Flapper Gasket
G-4375	American	470626	Luxury Collection Gasket	G-4435	Baker Hyd	35B1150	Spa Pak Pump Gasket
G-4376	Waterway	711-9870	Ozone/Cluster Jet Gasket		Little Giant	101601	Impeller Housing Gasket
G-4377	Hydro Air	10-6003	Adjustable Skimmer Gasket	G-4436	Sta Rite	C20-015	Pump Gasket
G-4378	American	472253	Diverter Jet Valve Gasket	G-4437	E-Z Chlor	12690-22	Silicone Valve Seal Gasket
G-4380	Hydro Air	10-5008	Whirlpool & USR Jet Gasket	G-4438	American	793006	Junction Box Sealing Gasket
G-4381	Brett	60-0002	Current Collector O-ring	G-4439	Muskin	038-3446	Adapter Gasket
G-4382	Martec	202-003	Suction Filter Flange Gasket	G-4440	American	550060	Sahara Filter Manhole Gasket
G-4383	Astral	600R0205	Valve Plug Gasket	G-4441	Sta Rite	C20-103	Duraglass Pump Gasket- Rubber
G-4384	Muskin	54013	Vac Attach Skimmer Gasket		Sta Rite	C20-123	Trap Outlet Gasket
G-4385	Muskin	54004	3/4" Washer	G-4442	Laars	E-244	Heater Gasket
G-4386	Pac Fab	07-4629	Commercial R Gasket	G-4443	Hayward	SX0180-G	Sand Filter Gasket
G-4387	Sta Rite	WC9-002	Sight Glass Gasket	G-4444	Sta Rite	—	Aqua Flyte H&L Gasket
G-4388	Paraport	C64069	Sight Glass Gasket	G-4445	Ampro	513	AP900 P/PL Valve LW Gasket
G-4389	Watermatic	1-110	Hopper Lid Gasket	G-4446	Ampro	511	AP900 P/PL Valve WA Gasket
G-4390	Waterway	711-7000	Spa Jet Body Gasket	G-4447	Jacuzzi	13-1022-07	Laser Sand Gasket
G-4391	Letro	JV-29	Jet Vac Gasket	G-4448	Speck	2923141000	Model 21-80 Gasket
G-4392	Astral	544R0106	Gasket	G-4449	Misc	—	2" Discharge Hose Flat Washer
G-4393	Rainbow	17-2263	1/2" Saddle Gasket	G-4450	Jacuzzi	13-0379-08	PJM Flange Gasket
G-4394	American	510173	Valve Gasket	G-4451	Watermatic	1-020	Rain Cover Gasket
G-4395	Richardson	5099-504	Air Bleeder Gasket	G-4452	Comfortzn.	CZXGKT7408	Bucket Gasket (For Kit Order 2)
G-4396	Hydro Quip	61-0001	Heater Union Gasket				

GASKETS-LISTED IN SSC# ORDER

SSC#	FITS OEM	FITS OEM#	DESCRIPTION	SSC#	FITS OEM	FITS OEM#	DESCRIPTION
G-4453	Cal Pump	—	Volute Gasket-No. 3	G-5005	Laars	S-606	Heater Tube Gasket
G-4454	Little Giant	102601	Volute Gasket-No. 2		Laars	S-708	Heater Washer
G-4455	Pac Fab	07-4015	Flow Valve Gasket	G-5006	Baker Hyd	00B7013	Filter Lid Ring (1969-71)
G-4456	Watermatic	1-370	Diverter Bracket Gasket		Baker Hyd	00B7028	Baker II Clamp Ring
G-4457	Little Giant	103601	Volute Gasket		Purex	70211	O0B7013 Gasket V-Band Lid
G-4458	American	863005	Drain Cap Gasket		Sta Rite	—	Ring For HRP36 Filter
G-4459	Jacuzzi	13-1023-06	CFR Gasket	G-5007	Marlow	25784	Pump Cover Gasket
	K-D Pools	13-1023-06	Cartridge Filter Gasket	G-5008	Purex	B-94	Square Cut Ring-Aqua
G-4460	Hayward	GMX0142DA2	Sand Filter Gasket		Purex	CB8-45	Brominator CB8-4 to CB8-45
G-4461	Misc	—	Oval Rope Eye Gasket		Hayward	SPX0145-T	Hydrotech Square Cut Ring
G-4462	Astral	00541R0404	Persius Sand Filter Drain Cap Gasket	G-5009	Baker Hyd	374790	Pump Lid Gasket
	E-Z Chlor	824050	3/8" Saddle Gasket	G-5010	Marlow	37479	Old Spa Pak Pump Gasket
G-4600	American	395001	Water Slinger				Mardur Strainer to Tank
G-4601	Slinger	—	Water Slinger-1 1/2" OD x 1/2" ID				Gasket (All Models)
G-4602	Watermatic	1-190	Collar Gasket	G-5011	Baker Hyd	00B7031	Top Mount Sand Filter Gasket
G-4603	Astral	713R0580030	Gasket	G-5012	Sta Rite	14962-21	Caprice Valve 1 1/2" Square Ring
G-4604	Astral	00361R0001	Light Gasket	G-5014	Baker Hyd	374780	Old Spa Pak Pump Gasket
G-4605	Astral	00352R0010	Compression Ring Gasket		Marlow	37478	Mardur 1/3 to 1 HP Pump Cover Gasket
G-4606	Brett	37-0101BK	Light System Gasket	G-5016	Baker Hyd	394040	Old Spa Pak Pump Gasket
G-4607	American	470690	Micro Jet Gasket		Jacuzzi	47-0466-02	Strainer and Case Gasket
G-4608	American	472240	Diverter Jet Gasket-2 or 3 Port		Marlow	39404	1 1/2 & 2 HP Mardur Pump Seal Gasket
G-4609	Waterway	711-1920	Clearwater Sand Top Gasket	G-5017	Marlow	25476	3/4 & 1 1/2 HP H Series Pump Diffuser Gasket
G-4610	E-Z Chlor	168090	Bottom Flowmeter Gasket				Pump Gasket
	E-Z Chlor	824090	Bottom Flowmeter Gasket	G-5019	Marlow	29038	Spa Element Gasket
G-4611	American	863005	Predator Drain Cap Gasket	G-5022	A.O. Smith	23789	5-Way Valve Gasket
G-4612	Laars	R00114	By-Pass Valve, Flow Control Gasket	G-5023	Jacuzzi	13-0378-09	Sand Filter Square Ring
	Muskin	54029	Discharge Fitting Intake Gasket		K-D Pools	13-0378-09	Gasket
G-4613				G-5024	American	510076	Separation Tank Lid Ring
G-4614	Sta Rite	05103-0101	Niche Gasket		Marine	99-8660-5	Large Separation Tank Gasket
G-4615	Sta Rite	17150-0007	4" Trap Gasket		Sta Rite	WC20-04	9.5" Separation Tank Gasket
G-4616	Pac Fab	61-4562	Washer	G-5026	Jacuzzi	47-0248-56	Dial Valve Square Ring
G-4617	Bio Lab	254840MN	Brominator Gasket	G-5027	Jacuzzi	13-0377-00	Multiport Valve Gasket
G-4618	Jacuzzi	13-1075-03	2" Valve Gasket	G-5028	Doughboy	308-1140	2" Inspection Port Ring
G-4619	Sta Rite	14971-0011	2" Multiport Valve Sight Glass Gasket		Lomart	053-215	Ring
G-4620	Sta Rite	L20-40	PLBC Small Gasket	G-5031	Jacuzzi	47-0232-54	Magnum Diffuser Square Ring
G-4621	Rainbow	18658	Leaf Trap Gasket for Cartridge	G-5033	Hayward	SPX1485-C	Sand Filter Elbow Ring
G-4622	Fiberstars	A9982	Large O-ring/Gasket	G-5034	Sta Rite	L21-001	Pump Diffuser Ring
G-4623	Jacuzzi	13-0015-08	Return Flange Gasket	G-5035	Jacuzzi	16-0920-12	XL-VII Pump Ring
G-4624	Purex	75114	Ortega Rubber Washer		Jacuzzi	47-0258-61	L Series Pump Square Ring
G-4625	American	982214	2" P Valve Sight Glass Gasket		Jacuzzi	47-0463-05	F Series Pump Square Seal Ring
G-4626	Comfortzn.	CZXGKT9216	C-SPA XI Inlet/Outlet Gasket	G-5036	Raypak	800080B	2" Flange Gasket
G-4627	Waterway	711-4020	2"-2 1/2" Union Gasket	G-5039	Baker Hyd	35B1117	Spa Pak Pump Lid Gasket
G-4628	American	422240	Diverter Jet Gasket-2 or 3 Port		Hayward	SPX0125-T	Pump Lid Ring
G-4629	Slinger	—	Water Slinger-1 3/8" OD x 1/2"ID-For 48 Frame Above Ground Pumps	G-5040	Marlow	—	1-2 HP AF Pump Diffuser Gasket
G-4630	Astral	00600R0001	Top Mount M/V Sight Glass Gasket	G-5041	Jacuzzi	13-0881-09	Underdrain Gasket
G-4631	Astral	11130R0006	Offline Chemical Feeder Gasket	G-5043	Arneson	D-10	Hose Washer
					Letro	LD-10	Hose Washer
G-4632	Waterway	806-0003	Clearwater Feeder Gasket		South Seas	—	Tube Gasket
G-4633	Astral	00470R0319	Chemical Feeder Drain Gasket	G-5045	American	395013	Seal Plate Ring (After 7/75)
				G-5046	Jacuzzi	47-0462-06	Square Diffuser Gasket
G-4634	Jandy	R0354400	SF-S Sand Filter Half Union Gasket	G-5047	Sta Rite	489031	Head Quad Ring
					Sta Rite	8490-31	Head Quad Ring
G-4635	Master	08490-0031	Master Turbo Clean Head Square Ring Seal	G-5048	Laars	—	Tube Late Style Gasket
					Laars	S-152	Aqua Dyne Late Style Tube Gasket
G-4636	Hayward	SPX1450-G	Turbo Boost Spa Jet Jumbo Return Fitting Gasket	G-5050	Wallace	27594	Chlorinator Gasket
				G-5051	Wallace	27593	Chlorinator Gasket
G-4637	Baker Hyd	30C3015	Sight Glass Gasket	G-5052	Baker Hyd	374820	Old Spa Pak Pump Gasket
	Baker Hyd	30C3115	Sight Glass Gasket		Marlow	37482	Mardur Pump Seal Plate Gasket
G-5001	Muskin	54008	Clamp Nut Gasket	G-5053	Muskin	037-3417	Body Ring
G-5002	Raypak	800086B	1" Square Cut O-ring	G-5055	American	510056	Small Separation Tank Ring
G-5003	Hayward	SPX0125-Z-3	Volute Pump Diffuser Ring		Marine	99-8088-5	Small Separation Tank Ring
G-5004	Laars	S-702	Heater Washer				

GASKETS-LISTED IN SSC# ORDER

SSC#	FITS OEM	FITS OEM#	DESCRIPTION	SSC#	FITS OEM	FITS OEM#	DESCRIPTION
G-5057	Laars	R0011400	H1-E2 Heater By-Pass Valve Gasket	G-5152	Hayward	ECX1105	DE Diaphragm Gasket for EC-65, 75-No Holes
	Laars	S-154	Flange Gasket	G-5153	Hayward	ECX1003	DE Diaphragm Gasket for EC-30, 40, 50-With Holes
	Laars	S-741	Flow Control Gasket (For Kit Order 3)	O-RING / GASKET KITS			
G-5058	Baker Hyd	00B7027	New Style Bulkhead Adapter Ring-Square Cut	K-6001	Hayward	SPX0735-GA	Vari Flo Valve O-ring Kit
	Purex	70213	New Style Bulkhead Union Ring	K-6002	Hayward	SPX0501-HJ	Light Lens O-ring Set
	Sta Rite	—	Ring For HRP36 Bulkhead Connection	K-6003	Hayward	CLX0200-LA	Chlorinator O-ring Kit
G-5060	Jacuzzi	47-0258-53	L Series (After 5/88), CFT & RPZ Square Ring	K-6004	Mec-O-Matic	88004-73	HJ & Barracuda O-ring Kit
	K-D Pools	47-0258-53	LR6 Gasket	K-6005	Lomart	—	Backwash Plunger Pipe O-ring Kit
G-5061	Pac Fab	35-5329	New Style Challenger Front Housing Square Ring	K-6006	Baker Hyd	00B7015	Piston O-ring Kit
G-5062	Muskin	54019	Cartridge Housing Gasket		Baker Hyd	31B0024	Piston O-ring Kit
G-5063	Laars	R-508	Header Gasket		Purex	70155	Piston O-ring Kit
G-5064	Richardson	5099-518	Sand Gasket		Sta Rite	—	31B0024 O-ring Repair Kit
G-5065	Little Giant	928028	Terminal House Gasket	K-6007	Sta Rite	WC298-88	PVC Valve Repair Parts Kit
G-5066	Laars	E-1164	Gasket/O-ring	K-6008	Premier	30-828-750	1 1/2" Valve O-ring/Gasket Kit
G-5067	Little Giant	928007	Square Cut Ring	K-6009	Premier	30-828-754	2" Valve O-ring/Gasket Kit
G-5069	Marlow	26144	H Diffuser Gasket-3/4 to 1 1/2 HP	K-6011	Deluxe Htr	20-3212	O-ring/Gasket Kit
			Gasket	K-6012	Muskin	72034	Cartridge Housing Gasket/O-ring Kit
G-5071	Little Giant	928024	Impeller Screw Gasket	K-6014	Muskin	72035	3 Position Valve Gasket Kit
G-5072	Sta Rite	33455-1047	AF Diffuser Gasket-1-2 HP	K-6015	Muskin	72036	5 Position Valve Gasket Kit
G-5073	Marlow	15621	H Diffuser Gasket-1/3 & 1/2 HP	K-6016	Muskin	72039	DLX Skimmer Gasket Kit
G-5074	Marlow	28983	Bottom Flowmeter Gasket	K-6017	Muskin	72038	Standard Skimmer Gasket Kit
			Square Ring	K-6018	Muskin	72040	Resin 5 Position Gasket/O-ring Kit
G-5075	E-Z Chlor	824090	Lid Ring	K-6019	Muskin	72037	Fill Port Gasket Kit
G-5076	Pac Fab	15-4494	AF Strainer Cover Gasket	K-6020	Hayward	DEX2420Z8A	Swimclear Cartridge Filter O-ring Kit
G-5077	Hydrotech	25475	Square Gasket				
G-5078	Marlow	32540	6 Spoke Spider Gasket (Prior to 1976)				
G-5079	Pac Fab	15-2509	5 Spoke Spider Gasket (After 1976)				
G-5104	American	510084	1 1/2" Spider Gasket-5 Spoke				
G-5105	American	510084	5 Spoke Spider Gasket (After 1976)				
G-5106	Astral	597R0102	5 Spoke Spider Gasket (After 1977)				
	Baker Hyd	30C3011	Spider Gasket for 1 1/2" Valve				
	Hayward	SPX0710-XD	6 Spoke Spider Gasket (Prior to 1977)				
G-5108	Pac Fab	27-1104	Spider Gasket for 1 1/2" Valve				
	Hayward	SPX0710-D	6 Spoke Spider Gasket (Prior to 1977)				
G-5111	Pac Fab	27-3012	1 1/2" Old Style Piston Seal				
G-5112	Pac Fab	27-3160	1 1/2" New Style Piston Seal				
G-5114	Pac Fab	27-3059	2" Piston Seal Ring				
	Premier	21-505	Piston O-ring				
G-5117	Purex	71722	Piston O-ring				
G-5119	Arneson	A-40	A1, A60 Booster Pump Endbell Gasket				
	Letro	LA-40	End Bell Gasket				
G-5124	Sta Rite	05057-118	Light Lens Gasket				
G-5126	Hayward	SPX0540-Z-2	Light Lens Gasket				
	Purex	70945	Light Lens Gasket				
G-5129	Marine	1560	V Cup O-ring-Square Cut				
	Pac Fab	88-500-1	Old Style Manifold V-ring (SCS Series Before 1977)				
G-5131	Hydrel	8092-S	Lens Gasket				
G-5136	Pac Fab	88-500-3	Large Manifold V-ring				
G-5142	Hayward	SPX0603-Z-2	Valve Teflon Piece With Split				
	Hayward	SPX0605-Z-2	Valve Teflon Piece With Split				
G-5146	American	510013	Multiport Valve Teflon Backup Ring				
G-5149	Laars	S-987	Jacket Hole Plug				
G-5150	Onyx	ON HSUPREME	Spa Pack Gasket				
G-5151	Laars	S00531	Heater Flange Gasket				

GASKET PICTURE GUIDE

<p>G-3001</p> <p>17 7/8" X 8 1/4"</p>	<p>G-3010</p> <p>12 1/4" X 9 11/16"</p>	<p>G-3021</p> <p>10 1/4" X 7 3/8"</p>	<p>G-3030</p> <p>5" X 5"</p>		<p>G-3101</p> <p>5 1/8" ID X 6 7/16" OD</p>	<p>G-3109</p> <p>5 13/16" ID X 6 15/16" OD</p>	<p>G-3119</p> <p>6 3/8" ID X 7 13/15" OD</p>
<p>G-3002</p> <p>7 3/4" X 7 7/16"</p>	<p>G-3011</p> <p>7" X 7 9/16"</p>	<p>G-3022</p> <p>7 3/8" X 7 3/8"</p>	<p>G-3031</p> <p>8 1/16" X 5 3/4"</p>		<p>G-3102</p> <p>6" ID X 7 1/2" OD</p>	<p>G-3110</p> <p>4 3/4" ID X 5 3/4" OD</p>	<p>G-3120</p> <p>5 1/2" ID X 6 15/16" OD</p>
<p>G-3003</p> <p>7 1/2" X 7 1/8"</p>	<p>G-3012</p> <p>8" X 16 3/8"</p>	<p>G-3023</p> <p>9 15/16" X 7 7/8"</p>	<p>G-3032</p> <p>10 7/16" X 8 1/4"</p>		<p>G-3103</p> <p>6 7/16" ID X 7 3/4" OD</p>	<p>G-3111</p> <p>4 9/16" ID X 6 1/2" OD</p>	<p>G-3121</p> <p>3" ID X 6 3/8" OD</p>
<p>G-3004</p> <p>14 1/2" X 8 1/2"</p>	<p>G-3014</p> <p>10 3/8" X 8 3/8"</p>	<p>G-3024</p> <p>13 1/2" X 9 5/8"</p>	<p>G-3034</p> <p>7 5/8" X 10"</p>		<p>G-3104</p> <p>5 15/16" ID X 6 11/16" OD</p>	<p>G-3112</p> <p>5 3/8" ID X 6 15/16" OD</p>	<p>G-3122</p> <p>5 5/8" ID X 6 3/4" OD</p>
<p>G-3006</p> <p>8" X 8 1/8"</p>	<p>G-3016</p> <p>9 3/4" X 7 11/16"</p>	<p>G-3025</p> <p>4 1/16" X 2 1/4"</p>	<p>G-3035</p> <p>6 7/16" X 4 3/8"</p>		<p>G-3105</p> <p>8 3/8" ID X 10" OD</p>	<p>G-3114</p> <p>6" ID X 6 3/4" OD</p>	<p>G-3123</p> <p>10 7/8" ID X 9 5/16" OD</p>
<p>G-3006K</p>	<p>G-3017</p> <p>9 1/2" X 6 1/2"</p>	<p>G-3026</p> <p>7 1/8" X 7 1/2"</p>	<p>G-3036</p> <p>7 3/4" X 7 1/4"</p>		<p>G-3106</p> <p>9 1/2" ID X 11 1/2" OD</p>	<p>G-3115</p> <p>4 11/16" ID X 5 3/4" OD</p>	<p>G-3124</p> <p>5 15/16" ID X 7 5/8" OD</p>
<p>G-3008</p> <p>17 1/2" X 8 1/8"</p>	<p>G-3018</p> <p>7 7/8" X 7 5/8"</p>	<p>G-3027</p> <p>13 1/8" X 10 1/2"</p>	<p>G-3037</p> <p>8 3/8" X 18 1/8"</p>		<p>G-3107</p> <p>5 3/4" ID X 7" OD</p>	<p>G-3116</p> <p>4 9/16" ID X 7 3/16" OD</p>	<p>G-3125</p> <p>6 3/8" ID X 6" OD</p>
<p>G-3009</p> <p>7" X 7 1/2"</p>	<p>G-3019</p> <p>7 7/8" X 7 11/16"</p>	<p>G-3028</p> <p>6 7/16" X 5 1/2"</p>	<p>G-3038</p> <p>8 1/4" X 10 1/2"</p>		<p>G-3108</p> <p>4 7/16" ID X 6 3/8" OD</p>	<p>G-3117</p> <p>4" ID X 5" OD</p>	<p>G-3126</p> <p>5 3/4" ID X 6 3/4" OD</p>
	<p>G-3020</p> <p>10 1/2" X 8 5/16"</p>	<p>G-3029</p> <p>7 1/2" X 7 1/8"</p>	<p>G-3039</p> <p>9 11/16" X 12 1/4"</p>			<p>G-3118</p> <p>8 1/4" ID X 9 3/4" OD</p>	<p>G-3127</p> <p>5 7/16" ID X 6 7/8" OD</p>

Please Note: Gasket dimensions listed are for identification purposes only

GASKET PICTURE GUIDE

G-3128 6 1/4" ID X 7 1/8" OD	G-3136 4 1/2" ID X 6 7/8" OD	G-3146 5 3/16" ID X 6 1/2" OD	G-3155 5 1/4" ID X 6 3/8" OD	G-3165 10 1/2" ID X 12" OD	G-3174 4 5/16" ID X 5 15/16" OD	G-3184 7/16" ID X 11/16" OD	G-3193 1 5/16" ID X 1 7/8" OD
G-3129 5" ID X 7 3/8" OD	G-3137 2 1/2" ID X 4 1/8" OD	G-3147 1 3/4" ID X 3" OD	G-3157 9 3/4" ID X 11 1/2" OD	G-3166 5 1/4" ID X 6" OD	G-3175 5/8" ID X 7/8" ID	G-3185 3/8" ID X 3/4" OD	G-3194 1/2" ID X 7/8" OD
G-3130 5 9/16" ID X 7 3/8" OD	G-3138 2 7/16" ID X 3 7/16" OD	G-3148 2 1/16" ID X 3 1/4" OD	G-3158 10 1/2" ID X 12 1/4" OD	G-3168 6 7/16" ID X 7 7/8" OD	G-3176 6 1/2" ID X 8" OD	G-3186 1/4" ID X 3/8" OD	G-3195 1 11/16" ID X 2 1/4" OD
G-3131 4 7/8" ID X 6 1/8" OD	G-3139 4 1/2" ID X 6" OD	G-3149 5 15/16" ID X 7 1/2" OD	G-3159 4 11/16" ID X 5 7/8" OD	G-3169 4 3/4" ID X 6" OD	G-3177 4 7/8" ID X 5 15/16" OD	G-3187 2 5/8" ID X 3 7/8" OD	G-3196 1 7/8" ID X 2 1/4" OD
G-3132 5 11/16" ID X 6 15/16" OD	G-3140 5 5/8" ID X 7" OD	G-3150 7 3/4" ID X 6" OD	G-3160 4" ID X 5" OD	G-3170 6 1/2" ID X 7 3/4" OD	G-3178 4 1/2" ID X 5 7/16" OD	G-3188 2 5/8" ID X 3 3/16" OD	G-3197 7/8" ID X 1 3/8" OD
G-3133 5 1/8" ID X 8 3/8" OD	G-3141 6 1/8" ID X 7 5/8" OD	G-3151 6 1/4" ID X 7 7/8" OD	G-3161 4 7/16" ID X 5 7/16" OD	G-3171 5 1/2" ID X 7 1/2" OD	G-3180 4 1/2" ID X 5 3/4" OD	G-3189 6 3/8" ID X 8" OD	G-3198 1/8" ID X 3/8" OD
G-3134 4 13/16" ID X 6" OD	G-3143 8 3/8" ID X 6 3/4" OD	G-3152 3 7/8" ID X 5 1/8" OD	G-3162 5 3/16" ID X 6 7/8" OD	G-3172 4 7/8" ID X 6 1/4" OD	G-3181 3/4" ID X 7/8" OD	G-3190 1 1/2" ID X 2 3/4" OD	G-3199 7/16" ID X 1 3/16" OD
G-3135 4 15/16" ID X 6 1/8" OD	G-3144 3 5/16" ID X 4 5/16" OD	G-3153 5 1/2" ID X 7 1/8" OD	G-3163 10 3/8" ID X 12 1/8" OD	G-3173 2 9/16" ID X 3 7/16" OD	G-3182 1/8" ID X 3/8" OD	G-3191 1 15/16" ID X 2 7/16" OD	G-3202 5 1/8" ID X 6 1/8" OD
	G-3145 1 1/2" ID X 2 13/16" OD	G-3154 2 5/8" ID X 3 13/16" OD	G-3164 7 3/4" ID X 9 3/8" OD		G-3183 6 13/16" ID X 7 1/2" OD	G-3192 1 5/8" ID X 2 1/4" OD	G-3203 6 3/8" X 5 3/4"

GASKET PICTURE GUIDE











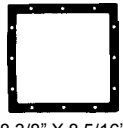
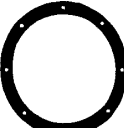



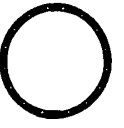
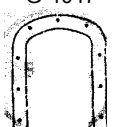
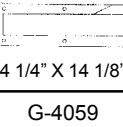

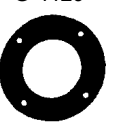



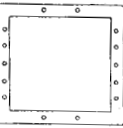
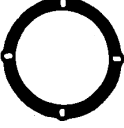





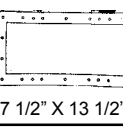





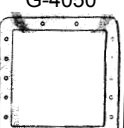

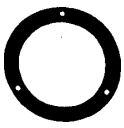

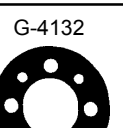

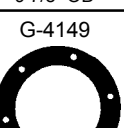
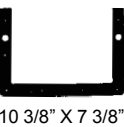
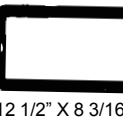
<p>G-3204</p> <p>3 5/8" X 3 1/8"</p>	<p>G-3215</p> <p>4 1/2" X 2 1/2"</p>	<p>G-3226</p> <p>5 9/16" ID X 5 15/16" OD</p>	<p>G-3236</p> <p>4 1/2" ID X 5 11/16" OD</p>	<p>G-3247</p> <p>6" ID X 6 13/16" OD</p>	<p>G-3256</p> <p>4 11/16" ID X 5 3/8" OD</p>	<p>G-3266</p> <p>4 5/16" X 4 5/16"</p>	<p>G-3281</p> <p>1 1/8" ID X 1 15/16" OD</p>
<p>G-3205</p> <p>6" X 5"</p>	<p>G-3216</p> <p>4 15/16" ID X 6 1/8" OD</p>	<p>G-3228</p> <p>5 1/2" X 5 1/2"</p>	<p>G-3237</p> <p>5 1/16" X 6 1/4"</p>	<p>G-3248</p> <p>5 1/2" X 3 1/8"</p>	<p>G-3257</p> <p>5 3/16" ID X 6 7/16" OD</p>	<p>G-3268</p> <p>2" ID X 2 1/2" OD</p>	<p>G-3282</p> <p>6 1/16" X 5 1/8"</p>
<p>G-3206</p> <p>3 1/4" X 1 5/8"</p>	<p>G-3217</p> <p>2 5/8" X 2 5/8"</p>	<p>G-3229</p> <p>5 3/8" ID X 5 1/4" OD</p>	<p>G-3238</p> <p>6 1/4" X 4 7/8"</p>	<p>G-3249</p> <p>4 11/16" ID X 5 7/16" OD</p>	<p>G-3258</p> <p>6" ID X 6 1/2" OD</p>	<p>G-3269</p> <p>7 5/8" X 6 1/4"</p>	<p>G-3283</p> <p>11 3/8" X 8 3/4"</p>
<p>G-3207</p> <p>3 1/4" X 3 1/4"</p>	<p>G-3218</p> <p>5 1/8" ID X 5 13/16" OD</p>	<p>G-3230</p> <p>2 3/4" ID X 3 1/4" OD</p>	<p>G-3239</p> <p>1/8" ID X 7/16" OD</p>	<p>G-3250</p> <p>5 1/2" X 4 3/4"</p>	<p>G-3259</p> <p>5 3/16" ID X 5 3/4" OD</p>	<p>G-3271</p> <p>2 13/16" X 2 13/16"</p>	<p>G-3284</p> <p>1 7/8" X 1"</p>
<p>G-3208</p> <p>4 7/8" X 4 1/2"</p>	<p>G-3219</p> <p>4" X 4"</p>	<p>G-3231</p> <p>1/2" ID X 2 3/8" OD</p>	<p>G-3240</p> <p>4 1/4" X 4 1/4"</p>	<p>G-3251</p> <p>4 1/2" ID X 5 3/16" OD</p>	<p>G-3261</p> <p>5 3/8" ID X 5 13/16" OD</p>	<p>G-3273</p> <p>1 1/4" ID X 1 7/8" OD</p>	
<p>G-3209</p> <p>5 3/8" X 4 7/16"</p>	<p>G-3220</p> <p>5 9/16" ID X 6 1/4" OD</p>	<p>G-3232</p> <p>2" ID X 2 7/16" OD</p>	<p>G-3241</p> <p>4 1/2" X 4 1/2"</p>	<p>G-3252</p> <p>3 1/4" X 2 9/16"</p>	<p>G-3262</p> <p>2 5/8" ID X 3 1/2" OD</p>	<p>G-3274</p> <p>1 7/8" X 2 3/16"</p>	
<p>G-3210</p> <p>5 5/8" ID X 5 15/16" OD</p>	<p>G-3222</p> <p>5 1/4" ID X 5 13/16" OD</p>	<p>G-3233</p> <p>3 3/4" X 2 15/16"</p>	<p>G-3242</p> <p>2 5/16" ID X 3 3/8" OD</p>	<p>G-3253</p> <p>4 7/8" ID X 5 5/8" OD</p>	<p>G-3263</p> <p>1 7/8" ID X 2 1/4" OD</p>	<p>G-3275</p> <p>1 3/4" ID X 2 5/8" OD</p>	
<p>G-3211</p> <p>1 5/8" ID X 3 3/8" OD</p>	<p>G-3224</p> <p>3 3/16" X 3 3/16"</p>	<p>G-3234</p> <p>1 7/8" ID X 2 1/4" OD</p>	<p>G-3243</p> <p>4" X 2 7/8"</p>	<p>G-3254</p> <p>1 7/8" ID X 2 3/8" OD</p>	<p>G-3264</p> <p>3/4" ID X 1" OD</p>	<p>G-3277</p> <p>1 1/8" ID X 2" OD</p>	
<p>G-3212</p> <p>4" ID X 6 5/8" OD</p>	<p>G-3225</p> <p>2 3/4" ID X 3 5/16" OD</p>	<p>G-3235</p> <p>1 11/16" ID X 2 3/16" OD</p>	<p>G-3245</p> <p>3 5/8" X 1 3/4"</p>	<p>G-3255</p> <p>4 1/8" X 3 1/2"</p>	<p>G-3265</p> <p>4" X 4"</p>	<p>G-3278</p> <p>2 1/4" ID X 5" OD</p>	
<p>G-3214</p> <p>6 1/4" X 5 3/4"</p>			<p>G-3246</p> <p>2 1/2" ID X 3 1/8" OD</p>			<p>G-3280</p> <p>3/8" ID X 13/16" OD</p>	

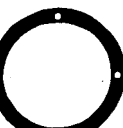
GASKET PICTURE GUIDE

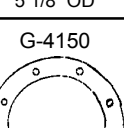
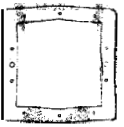
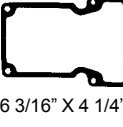
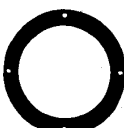
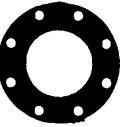

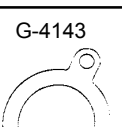
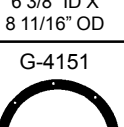
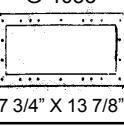

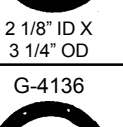
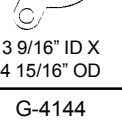
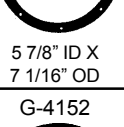
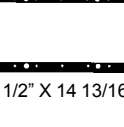











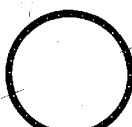





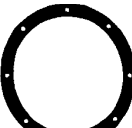





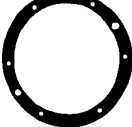



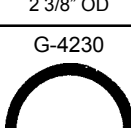

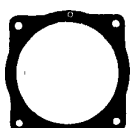
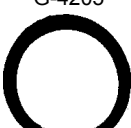

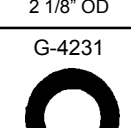





G-3400 6 9/16" ID X 7 7/8" OD	G-3409 7/8" ID X 1 1/4" OD		G-4001 8 1/8" X 7 3/4"	G-4011 10 1/4" X 5 3/4"	G-4020 23 3/4" X 3 1/2"	G-4027 9 7/16" X 5 3/4"	G-4036 7 1/16" X 7 3/8"
G-3401 7 5/16" ID X 9 3/8" OD	G-3410 4 1/2" ID X 6 7/8" OD		G-4002 7 7/8" X 7 7/8"	G-4012 7 1/2" X 10"		G-4029 9 1/2" X 7 1/4"	G-4037 3" X 6 3/8"
G-3402 5 15/16" ID X 7" OD	G-3411 6 5/8" ID X 8 3/4" OD		G-4003 13 3/8" X 7"	G-4014 9 1/2" X 8 3/8"		G-4029A 7 1/2" X 9 15/16"	G-4038 1" X 1"
G-3403 1 7/8" ID X 2 3/8" OD	G-3412 6 5/8" ID X 7 5/8" OD		G-4004 13 1/4" X 6 13/16"	G-4015 8 13/16" X 7 3/8"		G-4030 9 5/8" X 7 5/16"	G-4040 6 3/4" X 6 3/8"
G-3404 9 1/2" ID X 10" OD	G-3414 PICTURE NOT AVAILABLE AT TIME OF PRINTING		G-4005 5 3/16" X 2 3/8"	G-4016 6 1/2" X 3 3/8"		G-4031 8 3/4" X 7 3/8"	G-4041 7 13/16" X 7 3/8"
G-3405 7/8" ID X 1 1/4" OD	G-3415 PICTURE NOT AVAILABLE AT TIME OF PRINTING		G-4006 5 1/4" X 3"	G-4017 3 1/4" X 12"		G-4032 10 5/8" X 8 1/8"	G-4042 10 5/8" X 10 1/2"
G-3406 2 5/16" ID X 2 5/8" OD	G-3416 6 1/2" ID X 7 3/4" OD		G-4007 13 1/16" X 4"	G-4018 13" X 1 7/8"		G-4033 4 1/4" X 4 1/4"	G-4043 10" X 10"
G-3407 1 7/8" ID X 2 3/16" OD			G-4008 7 1/2" X 10"	G-4019 7" X 2 7/8"		G-4034 10 1/2" X 13"	G-4044 5" X 11 7/8"
G-3408 3/8" ID X 1 3/16" OD						G-4035 2 1/4" X 10"	G-4045 4 15/16" X 11 15/16"

Please Note: Gasket dimensions listed are for identification purposes only

GASKET PICTURE GUIDE

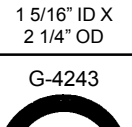
<p>G-4046</p>  <p>3 5/8" X 3 5/8"</p>	<p>G-4055</p>  <p>8 3/8" X 8 5/16"</p>		<p>G-4102</p>  <p>7 1/4" ID X 8 7/8" OD</p>	<p>G-4115</p>  <p>4 1/4" ID X 5 1/8" OD</p>	<p>G-4128</p>  <p>2 15/16" ID X 3 15/16" OD</p>	<p>G-4137</p>  <p>4" ID X 5 1/8" OD</p>	<p>G-4145</p>  <p>9 1/4" ID X 10 1/2" OD</p>
<p>G-4047</p>  <p>6 3/4" X 4 3/8"</p>	<p>G-4056</p>  <p>4 1/4" X 14 1/8"</p>		<p>G-4103</p>  <p>2 11/16" ID X 3 11/16" OD</p>	<p>G-4116</p>  <p>6 5/8" ID X 7 3/4" OD</p>	<p>G-4129</p>  <p>2 1/2" ID X 4 7/16" OD</p>	<p>G-4138</p>  <p>3 1/8" ID X 4 11/16" OD</p>	<p>G-4146</p>  <p>4 7/16" ID X 7 1/8" OD</p>
<p>G-4048</p>  <p>13 3/8" X 9 3/4"</p>	<p>G-4059</p>  <p>7 1/2" X 7 1/8"</p>		<p>G-4104</p>  <p>4 1/2" ID X 5 3/4" OD</p>	<p>G-4119</p>  <p>6 1/4" X 6 1/8"</p>	<p>G-4130</p>  <p>5 3/4" ID X 6 5/8" OD</p>	<p>G-4139</p>  <p>2 3/8" OD</p>	<p>G-4147</p>  <p>7" ID X 8 3/16" OD</p>
<p>G-4049</p>  <p>8 1/2" X 11 1/4"</p>	<p>G-4060</p>  <p>7 1/2" X 13 1/2"</p>		<p>G-4105</p>  <p>5 9/16" ID X 7 15/16" OD</p>	<p>G-4120</p>  <p>5" X 5"</p>	<p>G-4131</p>  <p>1 7/8" ID X 3 1/4" OD</p>	<p>G-4140</p>  <p>3 1/4" ID X 4 3/16" OD</p>	<p>G-4148</p>  <p>8 1/4" ID X 9 7/8" OD</p>
<p>G-4050</p>  <p>7 7/16" X 7 1/8"</p>	<p>G-4061</p>  <p>8" X 8 3/8"</p>		<p>G-4110</p>  <p>2 1/2" ID X 3 3/8" OD</p>	<p>G-4121</p>  <p>1 15/16" ID X 2 7/8" OD</p>	<p>G-4132</p>  <p>1 11/16" ID X 3 1/2" OD</p>	<p>G-4141</p>  <p>2 3/16" ID X 2 1/4" OD</p>	<p>G-4149</p>  <p>3 9/16" ID X 5 1/8" OD</p>
<p>G-4051</p>  <p>10 3/8" X 7 3/8"</p>	<p>G-4062</p>  <p>12 1/2" X 8 3/16"</p>		<p>G-4111</p>  <p>15/16" ID X 2 1/8" OD</p>	<p>G-4122</p>  <p>4 13/16" ID X 6" OD</p>	<p>G-4133</p>  <p>1 1/4" ID X 3 1/8" OD</p>	<p>G-4142</p>  <p>5 3/4" ID X 7" OD</p>	<p>G-4150</p>  <p>6 3/8" ID X 8 11/16" OD</p>
<p>G-4052</p>  <p>7 1/8" X 7 1/2"</p>	<p>G-4063</p>  <p>6 3/16" X 4 1/4"</p>		<p>G-4112</p>  <p>3 3/8" ID X 4 1/2" OD</p>	<p>G-4123</p>  <p>5 9/16" ID X 10" OD</p>	<p>G-4134</p>  <p>2 1/8" ID X 3 1/4" OD</p>	<p>G-4143</p>  <p>3 9/16" ID X 4 15/16" OD</p>	<p>G-4151</p>  <p>5 7/8" ID X 7 1/16" OD</p>
<p>G-4053</p>  <p>7 3/4" X 13 7/8"</p>			<p>G-4114</p>  <p>1 1/2" ID X 4" OD</p>	<p>G-4124</p>  <p>1 3/4" ID X 3 3/8" OD</p>	<p>G-4136</p>  <p>6 3/4" ID X 8 13/16" OD</p>	<p>G-4144</p>  <p>3 5/8" ID X 5 3/4" OD</p>	<p>G-4152</p>  <p>6" ID X 7 1/16" OD</p>
<p>G-4054</p>  <p>7 1/2" X 14 13/16"</p>				<p>G-4125</p>  <p>2 1/2" ID X 3 1/2" OD</p>			



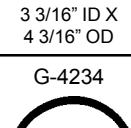
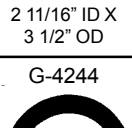







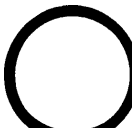

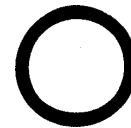

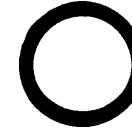
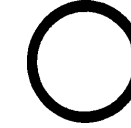

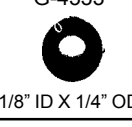

















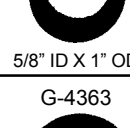

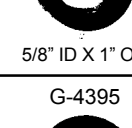
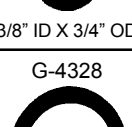



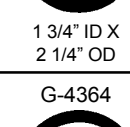

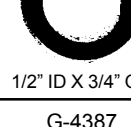
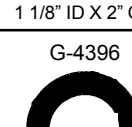
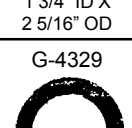
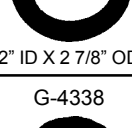
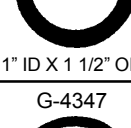

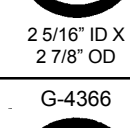

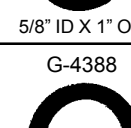
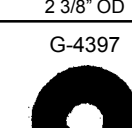
GASKET PICTURE GUIDE

<p>G-4153</p>  <p>3" ID X 4 1/4" OD</p>	<p>G-4161</p> <p>PICTURE NOT AVAILABLE AT TIME OF PRINTING</p>	<p>G-4201</p>  <p>2" ID X 2 3/8" OD</p>	<p>G-4210</p>  <p>1 3/16" ID X 1 5/8" OD</p>	<p>G-4219</p>  <p>1 13/16" ID X 2 7/16" OD</p>	<p>G-4227</p>  <p>3/4" ID X 1 5/8" OD</p>	<p>G-4237</p>  <p>2 5/8" ID X 3 1/2" OD</p>
<p>G-4154</p>  <p>4 5/16" ID X 5 7/8" OD</p>	<p>G-4162</p>  <p>14 3/8" ID X 16 1/8" OD</p>	<p>G-4202</p>  <p>2 1/8" ID X 3 9/16" OD</p>	<p>G-4211</p>  <p>2 1/4" ID X 3" OD</p>	<p>G-4220</p>  <p>1 7/8" ID X 3 1/4" OD</p>	<p>G-4228</p>  <p>1 11/16" ID X 2 1/4" OD</p>	<p>G-4238</p>  <p>2" ID X 3 1/8" OD</p>
<p>G-4155</p>  <p>6 5/16" ID X 8 3/8" OD</p>	<p>G-4163</p>  <p>5 3/4" ID X 7 3/16" OD</p>	<p>G-4203</p>  <p>15/16" X 1 5/16" OD</p>	<p>G-4212</p>  <p>5/8" ID X 1 3/8" OD</p>	<p>G-4221</p>  <p>1/4" ID X 1/2" OD</p>	<p>G-4229</p>  <p>1 11/16" ID X 2 3/8" OD</p>	<p>G-4239</p>  <p>1 1/4" ID X 2 3/8" OD</p>
<p>G-4156</p>  <p>6 1/4" ID X 8 11/16" OD</p>	<p>G-4164</p>  <p>5 1/8" ID X 6 1/2" OD</p>	<p>G-4204</p>  <p>1 7/8" ID X 2 1/2" OD</p>	<p>G-4214</p>  <p>15/16" ID X 1 1/4" OD</p>	<p>G-4222</p>  <p>3" ID X 3 11/16" OD</p>	<p>G-4230</p>  <p>1 5/8" ID X 2 1/8" OD</p>	<p>G-4240</p>  <p>1 5/16" ID X 2" OD</p>
<p>G-4157</p>  <p>4 7/16" ID X 7 1/8" OD</p>	<p>G-4186</p>  <p>5" ID X 6 1/8" OD</p>	<p>G-4205</p>  <p>1" ID X 1 5/16" OD</p>	<p>G-4215</p>  <p>1 1/16" ID X 1 13/16" OD</p>	<p>G-4223</p>  <p>3 3/16" ID X 3 3/4" OD</p>	<p>G-4231</p>  <p>9/16" ID X 1" OD</p>	<p>G-4241</p>  <p>3 1/2" ID X 4 3/8" OD</p>
<p>G-4158</p>  <p>6 7/8" ID X 8 3/4" OD</p>		<p>G-4206</p>  <p>1/2" ID X 1 1/4" OD</p>	<p>G-4216</p>  <p>2 1/16" ID X 3" OD</p>	<p>G-4224</p>  <p>3/4" ID X 1 3/16" OD</p>	<p>G-4232</p>  <p>1 3/16" ID X 1 7/16" OD</p>	<p>G-4242</p>  <p>1 5/16" ID X 2 1/4" OD</p>
<p>G-4159</p>  <p>10 1/2" ID X 12" OD</p>		<p>G-4207</p>  <p>2" ID X 3" OD</p>	<p>G-4217</p>  <p>13 1/2" X 10 3/8"</p>	<p>G-4225</p>  <p>9/16" ID X 13/16" OD</p>	<p>G-4233</p>  <p>3 3/16" ID X 4 3/16" OD</p>	<p>G-4243</p>  <p>2 11/16" ID X 3 1/2" OD</p>
<p>G-4160</p>  <p>1 9/16" ID X 2 1/4" OD</p>		<p>G-4208</p>  <p>1/8" ID X 3/4" OD</p>	<p>G-4218</p>  <p>6 3/4" ID X 7 13/16" OD</p>	<p>G-4226</p>  <p>1 1/16" ID X 1 3/8" OD</p>	<p>G-4234</p>  <p>5" ID X 5 1/2" OD</p>	<p>G-4244</p>  <p>2 1/2" ID X 3 1/2" OD</p>

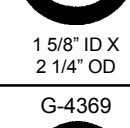
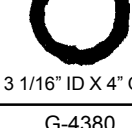
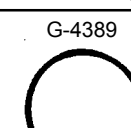

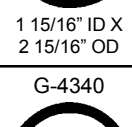
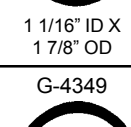

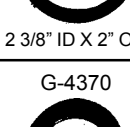
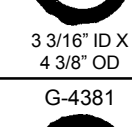
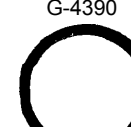

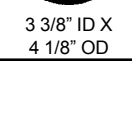
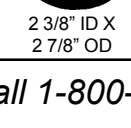
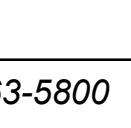
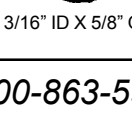
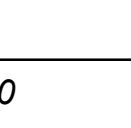
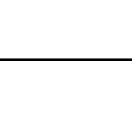



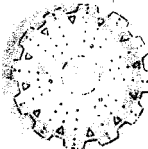

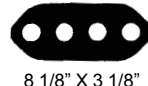

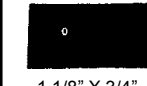
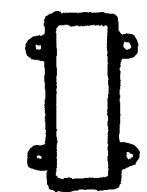



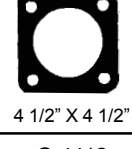

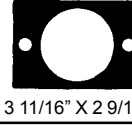

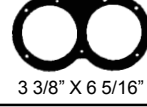



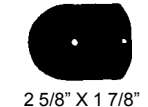
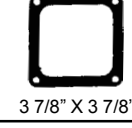
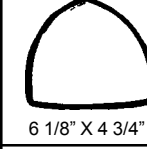

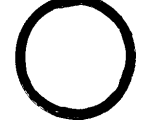

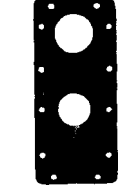





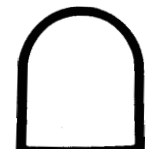



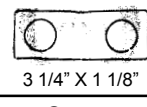

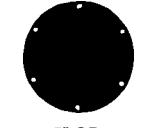





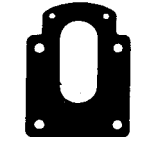
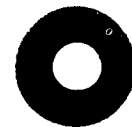
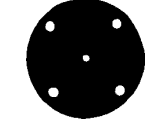

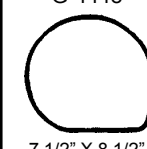

GASKET PICTURE GUIDE

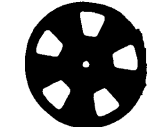
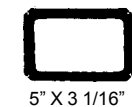
G-4245 1 13/16" ID X 2 9/16" OD	G-4253 9/16" ID X 1 1/4" OD	G-4261 1 5/8" ID X 2 3/16" OD	G-4270 5 7/8" ID X 7 3/16" OD	G-4279 1" ID X 2" OD	G-4287 2" ID X 2 7/8" OD	G-4297 1/16" ID X 5/16" OD	G-4310 2" ID X 2 1/2" OD
G-4246 2 1/8" ID X 2 5/8" OD	G-4254 5/8" ID X 1 1/2" OD	G-4262 15/16" ID X 1 1/8" OD	G-4271 3" ID X 3 1/2" OD	G-4280 5/8" ID X 1" OD	G-4288 2" ID X 2 3/8" OD	G-4298 1 1/4" ID X 2" OD	G-4311 1 15/16" ID X 3 1/2" OD
G-4247 2 1/16" ID X 3 9/16" OD	G-4255 3/4" ID X 1 1/4" OD	G-4263 3/8" ID X 1 1/8" OD	G-4272 4 1/2" ID X 5 1/2" OD	G-4281 9/16" ID X 13/16" OD	G-4290 2 7/16" ID X 3 3/8" OD	G-4299 2 5/8" ID X 3 3/8" OD	G-4312 3/16" ID X 9/16" OD
G-4248 4" ID X 4 9/16" OD	G-4256 13/16" ID 1 3/4" OD	G-4264 10 1/4" ID X 11 1/8" OD	G-4273 4 1/8" ID X 5" OD	G-4282 1 3/8" ID X 2 1/4" OD	G-4291 2" ID X 3" OD	G-4300 7/8" ID X 1 1/4" OD	G-4314 3/4" ID X 1 1/4" OD
G-4249 2 1/16" ID X 2 15/16" OD	G-4257 2 5/16" ID X 3 1/4" OD	G-4265 1 15/16" ID X 3" OD	G-4274 7 7/8" ID X 8 3/4" OD	G-4283 7 7/8" ID X 9 3/8" OD	G-4292 1 1/4" ID X 1 5/8" OD	G-4303 3/4" ID X 1 1/4" OD	G-4315 1" ID X 1 1/2" OD
G-4250 1 3/8" ID X 1 13/16" OD	G-4258 1/2" ID X 1 13/16" OD	G-4266 1 3/4" ID X 2 1/2" OD	G-4275 3/16" ID X 9/16" OD	G-4284 1 9/16" ID X 1 15/16" OD	G-4294 2 1/4" ID X 2 11/16" OD	G-4304 2 1/4" ID X 3 3/8" OD	G-4316 1" ID X 1 1/2" OD
G-4251 5/16" ID X 1" OD	G-4259 2 1/2" ID X 3 7/16" OD	G-4267 1/2" ID X 3/4" OD	G-4276 3" ID X 3 3/8" OD	G-4285 5/8" ID X 1 1/4" OD	G-4295 1" ID X 1 1/2" OD	G-4305 13/16" ID X 1 7/16" OD	G-4319 5/8" ID X 1" OD
G-4252 13/16" ID X 2 1/16" OD	G-4260 1 9/16" ID X 2 9/16" OD	G-4268 2 1/2" ID X 3" OD	G-4277 6" ID X 6 1/2" OD	G-4286 3" ID X 4 1/16" OD	G-4296 1 7/8" ID X 2 3/4" OD	G-4306 2" ID X 2 3/8" OD	G-4320 3/4" ID X 1 1/8" OD
	G-4269 5 3/16" ID X 6 1/16" OD	G-4278 2 9/16" ID X 3 7/16" OD				G-4309 1 1/4" ID X 1 3/4" OD	G-4322 1 3/16" ID X 2" OD

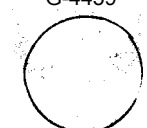

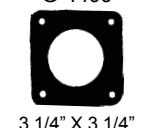
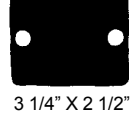

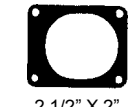
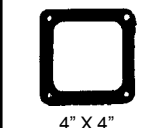
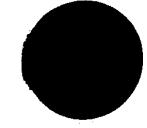







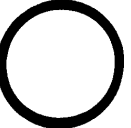

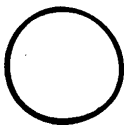



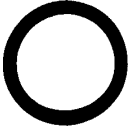

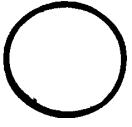
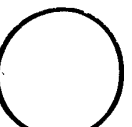



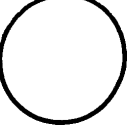
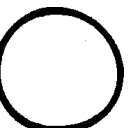
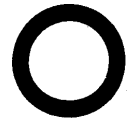



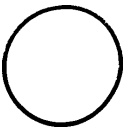
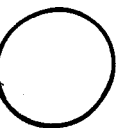
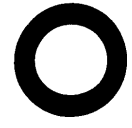
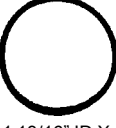

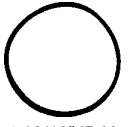



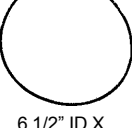

GASKET PICTURE GUIDE

G-4323  1 11/16" ID X 2 1/4" OD	G-4332  3 1/4" ID X 3 7/8" OD	G-4341  2 3/8" ID X 3" OD	G-4350  2 1/4" ID X 2 15/16" OD	G-4359  2 1/8" ID X 3" OD	G-4371  2 3/4" ID X 3 1/2" OD	G-4382  6 3/4" ID X 8 1/8" OD	G-4391  3 1/16" ID X 4 3/8" OD
G-4324  2 3/8" ID X 3 1/16" OD	G-4333  1/8" ID X 1/4" OD	G-4342  7/16" ID X 1 11/16" OD	G-4352  2 5/8" ID X 3 3/8" OD	G-4360  1 11/16" ID X 2 7/16" OD	G-4373  1 13/16" ID X 3 5/16" OD	G-4383  1/2" ID X 3/4" OD	G-4392  2 3/16" ID X 2 13/16" OD
G-4325  1/2" ID X 15/16" OD	G-4334  1/2" ID X 2" OD	G-4343  2 1/2" ID X 3 1/16" OD	G-4353  1 9/16" ID X 2 1/4" OD	G-4361  1 1/8" ID X 2" OD	G-4374  1 11/16" ID X 2 1/8" OD	G-4384  5 1/16" ID X 6 1/8" OD	G-4393  1/2" ID X 1" OD
G-4326  3/4" ID X 1 1/4" OD	G-4335  1 3/16" ID X 1 11/16" OD	G-4344  1/4" ID X 5/8" OD	G-4354  2 1/2" ID X 3 3/16" OD	G-4362  5/8" ID X 1" OD	G-4375  2 3/8" ID X 2 15/16" OD	G-4385  5/8" ID X 1" OD	G-4394  5/8" ID X 1" OD
G-4327  3/8" ID X 3/4" OD	G-4336  2 3/8" ID X 3 5/8" OD	G-4345  5 9/16" ID X 5 13/16" OD	G-4355  2 7/16" ID X 3 1/8" OD	G-4363  1 3/4" ID X 2 1/4" OD	G-4376  15/16" ID X 1 5/16" OD	G-4386  1/2" ID X 3/4" OD	G-4395  1 1/8" ID X 2" OD
G-4328  1 3/4" ID X 2 5/16" OD	G-4337  2" ID X 2 7/8" OD	G-4346  1" ID X 1 1/2" OD	G-4356  3 1/2" ID X 4 3/8" OD	G-4364  2 5/16" ID X 2 7/8" OD	G-4377  2 13/16" ID X 3 11/16" OD	G-4387  5/8" ID X 1" OD	G-4396  1 1/2" ID X 2 3/8" OD
G-4329  3/4" ID X 1 1/8" OD	G-4338  1 9/16" ID X 2 3/8" OD	G-4347  7 1/8" ID X 8 3/4" OD	G-4357  1 1/2" ID X 1 7/8" OD	G-4366  1 5/8" ID X 2 1/4" OD	G-4378  3 1/16" ID X 4" OD	G-4388  1" ID X 1 1/4" OD	G-4397  3/16" ID X 5/16" OD
G-4330  3/4" ID X 1 1/16" OD	G-4339  1 15/16" ID X 2 15/16" OD	G-4348  1 1/16" ID X 1 7/8" OD	G-4358  1 1/2" ID X 2 5/16" OD	G-4369  2 3/8" ID X 2" OD	G-4380  3 3/16" ID X 4 3/8" OD	G-4389  12" ID X 13 3/8" OD	G-4398  3/4" ID X 1 1/8" OD
G-4331  1 1/4" ID X 1 7/16" OD	G-4340  3 3/8" ID X 4 1/8" OD	G-4349  2 3/8" ID X 2 7/8" OD	G-4370  1" ID X 1 5/8" OD	G-4381  3/16" ID X 5/8" OD	G-4390  5 3/4" ID X 6 7/8" OD	G-4399  2 3/4" ID X 3 1/4" OD	

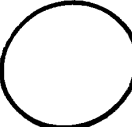
GASKET PICTURE GUIDE

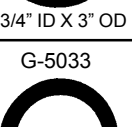
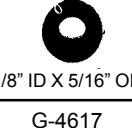
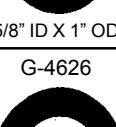
<p>G-4401</p>  <p>4" ID X 14 3/4" OD</p>	<p>G-4410</p>  <p>3 1/4" X 3 1/4"</p>	<p>G-4420</p>  <p>8 1/8" X 3 1/8"</p>	<p>G-4431</p>  <p>5 1/4" X 3"</p>	<p>G-4442</p>  <p>1 1/8" X 3/4"</p>	<p>G-4452</p>  <p>8 1/2" X 3 5/8"</p>	<p>G-4462</p>  <p>9/16" OD</p>	<p>G-4600</p>  <p>3/8" ID X 3/4" OD</p>
<p>G-4402</p>  <p>2 7/16" ID X 16 1/2" OD</p>	<p>G-4411</p>  <p>4 1/2" X 4 1/2"</p>	<p>G-4421</p>  <p>1 1/4" OD</p>	<p>G-4432</p>  <p>3 11/16" X 2 9/16"</p>	<p>G-4443</p>  <p>1 3/16" OD</p>	<p>G-4453</p>  <p>3 3/8" X 6 5/16"</p>		<p>G-4601</p>  <p>1/2" ID X 1 9/16" OD</p>
<p>G-4403</p>  <p>3 7/16" ID X 16 5/8" OD</p>	<p>G-4412</p>  <p>6 1/4" X 5 5/8"</p>	<p>G-4422</p>  <p>2 5/8" X 1 7/8"</p>	<p>G-4433</p>  <p>3 7/8" X 3 7/8"</p>	<p>G-4444</p>  <p>6 1/8" X 4 3/4"</p>	<p>G-4454</p>  <p>2 9/16" X 2 1/2"</p>		<p>G-4602</p>  <p>2 13/16" ID X 3 1/4" OD</p>
<p>G-4404</p>  <p>3 1/2" ID X 18 1/2" OD</p>	<p>G-4414</p>  <p>8 1/8" X 3 3/4"</p>	<p>G-4423</p>  <p>3 15/16" X 3"</p>	<p>G-4434</p>  <p>4" X 4"</p>	<p>G-4445</p>  <p>2" OD</p>	<p>G-4455</p>  <p>3 7/16" X 2 7/16"</p>		<p>G-4603</p>  <p>2 3/8" ID X 2 3/4" OD</p>
<p>G-4405</p>  <p>6 1/8" X 7 3/16"</p>	<p>G-4415</p>  <p>1 1/2" OD</p>	<p>G-4424</p>  <p>1 1/2" OD</p>	<p>G-4435</p>  <p>2 3/16" X 2 1/8"</p>	<p>G-4446</p>  <p>1/8" OD</p>	<p>G-4456</p>  <p>3 1/4" X 1 1/8"</p>		<p>G-4604</p>  <p>1/4" ID X 13/16" OD</p>
<p>G-4406</p>  <p>5" OD</p>	<p>G-4416</p>  <p>3 5/8" X 3 5/8"</p>	<p>G-4425</p>  <p>1 3/16" OD</p>	<p>G-4436</p>  <p>4 1/4" X 4 1/4"</p>	<p>G-4447</p>  <p>1 3/16" OD</p>	<p>G-4457</p>  <p>3 11/16" X 3 1/2"</p>		<p>G-4605</p>  <p>7/8" ID X 1 1/8" OD</p>
<p>G-4407</p>  <p>5 5/8" X 4 1/4"</p>	<p>G-4417</p>  <p>7/16" ID X 1 1/4" OD</p>	<p>G-4426</p>  <p>3 1/4" OD</p>	<p>G-4437</p>  <p>1 1/2" X 1 1/2"</p>	<p>G-4448</p>  <p>7 1/2" X 8 1/2"</p>	<p>G-4458</p>  <p>1 5/8" OD</p>		<p>G-4606</p>  <p>2 1/2" ID X 3 3/16" OD</p>
<p>G-4408</p>  <p>4 13/16" X 2 5/8"</p>	<p>G-4418</p>  <p>1 1/4" OD</p>	<p>G-4427</p>  <p>7 3/4" OD</p>	<p>G-4438</p>  <p>5" X 3 1/16"</p>	<p>G-4449</p>  <p>1 5/8" ID X 2 3/8" OD</p>	<p>G-4459</p>  <p>13/16" OD</p>		<p>G-4607</p>  <p>1 5/8" ID X 2 3/16" OD</p>
<p>G-4409</p>  <p>3 1/4" X 3 1/4"</p>	<p>G-4419</p>  <p>3 1/4" X 2 1/2"</p>	<p>G-4428</p>  <p>1/4" ID X 3/4" OD</p>	<p>G-4439</p>  <p>2 1/2" X 2"</p>	<p>G-4450</p>  <p>4" X 4"</p>	<p>G-4460</p>  <p>3/4" OD</p>		<p>G-4608</p>  <p>3" ID X 4" OD</p>

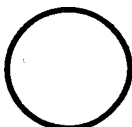
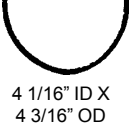
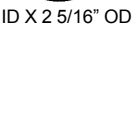
GASKET PICTURE GUIDE

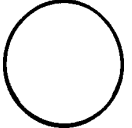
G-4609  5 3/4" ID X 7 1/8" OD	G-4618  5/8" ID X 1" OD	G-4627  2 1/8" ID X 2 7/8" OD	G-4636  4 9/16" ID X 5 11/16" OD	G-5001  1" ID X 1 5/16" OD	G-5009  5 1/2" ID X 5 3/4" OD	G-5022  1 3/16" ID X 1 3/8" OD
G-4610  1/2" ID X 1 1/16" OD	G-4619  5/8" ID X 1" OD	G-4628  3 3/4" ID X 4 1/2" OD	G-4637  5/8" ID X 1" OD	G-5002  1 1/16" ID X 1 7/16" OD	G-5010  3 3/4" ID X 4 1/16" OD	G-5023  5 5/8" ID X 6 1/16" OD
G-4611  13/16" ID X 1 9/16" OD	G-4620  1 1/4" ID X 1 5/8" OD	G-4629  1/2" ID X 1 1/8" OD		G-5003  1 15/16" ID X 2 3/8" OD	G-5011  6 1/2" ID X 6 7/8" OD	G-5024  9 5/16" ID X 9 13/16" OD
G-4612  1 15/16" ID X 2 5/8" OD	G-4621  2 1/16" ID X 3" OD	G-4630  5/8" ID X 1" OD		G-5004  13/16" ID X 1 1/32" OD	G-5012  6 1/2" ID X 7 1/16" OD	G-5026  4 3/4" ID X 5" OD
G-4613  1 15/16" ID X 3 1/8" OD	G-4622  1 13/16" ID X 2 1/8" OD	G-4631  3/8" ID X 3/4" OD		G-5005  3/32" ID X 1 1/32" OD	G-5014  4 13/16" ID X 5 1/8" OD	G-5027  9 15/16" ID X 10 7/16" OD
G-4614  3 5/8" ID X 6" OD	G-4623  2 1/4" ID X 3 5/16" OD	G-4632  3/8" ID X 3/4" OD		G-5006  8 1/16" ID X 8 13/32" OD	G-5016  6 1/2" ID X 6 3/4" OD	G-5028  2" ID X 2 1/4" OD
G-4615  4 1/4" ID X 4 5/8" OD	G-4624  1/8" ID X 5/16" OD	G-4633  1/2" ID X 3/4" OD		G-5007  6" ID X 6 3/8" OD	G-5017  1 13/16" ID X 2 7/32" OD	G-5031  2 3/4" ID X 3" OD
G-4616  1/8" ID X 5/16" OD	G-4625  5/8" ID X 1" OD	G-4634  3 1/8" ID X 3 7/8" OD		G-5008  4 15/16" ID X 5 15/32" OD	G-5019  4 1/16" ID X 4 3/16" OD	G-5033  2" ID X 2 5/16" OD
G-4617  9/16" ID X 1" OD	G-4626  2" ID X 3" OD	G-4635  2 7/8" ID X 3 3/16" OD				

Please Note: Gasket dimensions listed are for identification purposes only

GASKET PICTURE GUIDE

<p>G-5034</p> <p>1 3/4" ID X 2 3/16" OD</p>	<p>G-5046</p> <p>2 7/8" ID X 3 1/8" OD</p>	<p>G-5057</p> <p>1 15/16" ID X 2 11/16" OD</p>	<p>G-5066</p> <p>3/8" ID X 5/8" OD</p>	<p>G-5078</p> <p>6 1/4" ID X 6 7/8" OD</p>	<p>G-5104</p> <p>6 1/16" OD</p>	<p>G-5126</p> <p>7" ID X 7 3/4" OD</p>	<p>G-5152</p> <p>12 1/4" ID X 15" OD</p>
<p>G-5035</p> <p>6 1/8" ID X 6 7/16" OD</p>	<p>G-5047</p> <p>2 3/4" ID X 3" OD</p>	<p>G-5058</p> <p>2 1/16" ID X 2 3/8" OD</p>	<p>G-5067</p> <p>2 1/16" ID X 2 3/16" OD</p>	<p>G-5079</p> <p>8 3/4" ID X 9 3/16" OD</p>	<p>G-5105</p> <p>6 1/16" OD</p>	<p>G-5129</p> <p>1 9/16" ID X 2 1/8" OD</p>	<p>G-5153</p> <p>9 7/8" ID X 14" OD</p>
<p>G-5036</p> <p>2 3/16" ID X 2 13/16" OD</p>	<p>G-5048</p> <p>3/4" ID X 1 5/16" OD</p>	<p>G-5060</p> <p>6 1/8" ID X 6 3/8" OD</p>	<p>G-5069</p> <p>1 13/16" ID X 2 3/16" OD</p>		<p>G-5106</p> <p>5 3/8" OD</p>	<p>G-5131</p> <p>2 11/16" ID X 3 5/16" OD</p>	
<p>G-5039</p> <p>4 5/16" ID X 4 5/8" OD</p>	<p>G-5050</p> <p>7/16" ID X 3/4" OD</p>	<p>G-5061</p> <p>10 1/4" ID X 10 3/4" OD</p>	<p>G-5071</p> <p>4 1/2" ID X 4 5/8" OD</p>	<p>G-5072</p> <p>1/4" ID X 1/2" OD</p>	<p>G-5108</p> <p>5 3/8" OD</p>	<p>G-5136</p> <p>1 1/2" ID X 2" OD</p>	
<p>G-5040</p> <p>2 3/16" ID X 2 7/16" OD</p>	<p>G-5051</p> <p>3/8" ID X 5/8" OD</p>	<p>G-5062</p> <p>5 3/4" ID X 6 1/8" OD</p>	<p>G-5073</p> <p>2 3/16" ID X 2 7/16" OD</p>		<p>G-5112</p> <p>3/8" ID X 1 11/16" OD</p>	<p>G-5142</p> <p>11/16" ID X 13/16" OD</p>	
<p>G-5041</p> <p>1 3/4" ID X 2 3/4" OD</p>	<p>G-5052</p> <p>6 11/16" ID X 6 13/16" OD</p>	<p>G-5063</p> <p>3/4" ID X 1 5/16" OD</p>	<p>G-5074</p> <p>1 1/2" ID X 1 13/16" OD</p>	<p>G-5114</p> <p>3/8" ID X 2" OD</p>	<p>G-5146</p> <p>9/16" ID X 3/4" OD</p>		
<p>G-5043</p> <p>5/8" ID X 1 1/16" OD</p>	<p>G-5053</p> <p>5" ID X 5 1/8" OD</p>	<p>G-5064</p> <p>1 1/4" ID X 2 7/16" OD</p>	<p>G-5075</p> <p>1/2" ID X 11/16" OD</p>		<p>G-5117</p> <p>7/16" ID X 1 9/16" OD</p>	<p>G-5149</p> <p>2 1/2" OD</p>	
<p>G-5045</p> <p>7 3/16" ID X 7 7/16" OD</p>	<p>G-5055</p> <p>6 3/16" ID X 6 9/16" OD</p>	<p>G-5065</p> <p>2 3/4" ID X 2 7/8" OD</p>	<p>G-5076</p> <p>6 1/8" ID X 6 3/8" OD</p>	<p>G-5119</p> <p>6 3/4" OD</p>	<p>G-5150</p> <p>4 1/2" X 5"</p>		
			<p>G-5077</p> <p>5" ID X 5 1/2" OD</p>		<p>G-5124</p> <p>6 1/8" ID X 7 1/2" OD</p>	<p>G-5151</p> <p>1 5/8" ID X 2 3/16" OD</p>	

REPLACEMENT PUMP SEALS



TYPE: A

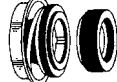

TYPE: B



TYPE: C

<p>MS-100 TYPE: A SHAFT DIA.: 5/8" Anthony 04547 Baker Hydro MI-29-3 Purex (Eastside) P-28280 Sears 42G2377W Model 390, 154, 3/HP Sta Rite U109-93SS For Dura Glass, AJ Ser., Max E Glas, PLBC Ser.; U9-6, A, C, D, F, G, H Series; P2RA 1/3-2 HP; U109-6A Swimquip P-61, XLII, XLIII, XLIV</p>	<p>MS-201 TYPE: A SHAFT DIA.: 3/4" Advance 6C-201 American 395005-Americana, Bronze-Noryl Baker Hydro 35B1109 Flint & Walling 126544, 126545 Gulf 34106201 For Power Tech Harmsco 201 Hayward SPX1600-Z-2-Max Flo, Super, SuperII Homelite 75911-A Hydro (All) Jacuzzi 10-1390-04 For Magnum, RC; 10-0420-00, 10-0477-00, 10-0486-00, 10-0487-00, 10-1502-09 Luitweiler 3/4" x 1.373" Marlow 38592 For Argonaut, Mardur Martec 320-119 Pac Fab 35-4001 For Hydropump; 35-0002, 35-4894 Premier 31-812-120T, 225/255, 300, 725/756 Purex P-28300 For L Series (Eastside); P-29300 For AH Series Sta Rite U9-358SS-JS, JT Series; U109-047 Swimquip For XLVI/XLVII Series Vico PPSFSEAL</p>	<p>MS-501 TYPE: A SHAFT DIA.: 5/8" Purex P-28322 For Aquatron</p>
<p>MS-101 TYPE: A SHAFT DIA.: 3/4" Myers 11416-A, A2, A3</p>		<p>MS-601 TYPE: B SHAFT DIA.: 3/4" Jandy R0338200 Waterco 634016 For Supatuff Pump</p>
<p>MS-142 TYPE: B SHAFT DIA.: 1/2" Diaclear 35104, 36100 Lomart 040-028 Muskin 72008 (09-2013)</p>		<p>MS-642 TYPE: B SHAFT DIA.: 5/8" Doughboy 1128-1006</p>
<p>MS-150 TYPE: B SHAFT DIA.: 5/8" Lomart Muskin</p>		<p>MS-703 TYPE: C SHAFT DIA.: 7/8" Marine 9524 Sta Rite U109-170 Cup Style</p>
<p>MS-162 TYPE: A SHAFT DIA.: 1/2" Jacuzzi 10-0563-00 Peerless 2665554 Sears 259-043, W6476 Sta Rite U109-068</p>	<p>MS-299 TYPE: A SHAFT DIA.: 5/8" Doughboy 306-1006</p>	<p>MS-800 TYPE: C SHAFT DIA.: 5/8" Flint & Walling 131100, 132377, AC-16</p>
<p>MS-163 TYPE: B SHAFT DIA.: 1/2" Ampro 504-D Diaclear 35100 for Cast Iron, Lexan 200 Series; MS-12 Thru MS-18 Lomart 040-027, 040-029 Muskin 09-2001 Sta Rite U109-068</p>	<p>MS-358 TYPE: C SHAFT DIA.: 3/4" Jacuzzi 10-0479-00 Marine 15151</p>	<p>MS-851 TYPE: A SHAFT DIA.: 3/4" Sta Rite 37400-00275</p>
<p>MS-163C TYPE: CERAMIC ONLY SHAFT DIA.: 5/8" Muskin 54048</p>	<p>MS-359 TYPE: C SHAFT DIA.: 5/8" Jacuzzi 10-0478-00, 10-0506-00, 10-1202-00</p>	<p>MS-877 TYPE: C SHAFT DIA.: 3/4" Jacuzzi 10-1203-01, 10-1203-19</p>
<p>MS-200 TYPE: A SHAFT DIA.: 5/8" Advance 6C-200 Ampro 606-78 Aqua Flo 92509020, 92500150, FF-14 Arneson A-08 Baker Hydro 35B1178 Doughboy 306-1007 Hayward SPX1250X-Z-2 For Cast Iron Jacuzzi 10-1436-00 For LCM, LCU, LR Series; 10-0476-00, 10-0002-06 Letro A-08 Lomart 1121-1057 Pac Fab 35-4545 For Challenger, Dynamite, Dynamo, Dynatron, Pinnacle WMC JS-1702</p>	<p>MS-360 TYPE: A SHAFT DIA.: 1" Pac Fab 07-1725 Purex P-28175 For C Series (Eastside)</p>	<p>MS-1000 TYPE: B SHAFT DIA.: 5/8" Acura 1090 American 397012 For Americana II, Bronze- Bronze, Eagle, Maxim, Power Glas, Ultra Flo; 397020 Ampro AP-304D Aqua Flo 92509040 For A, B, C, D Series, Dominator; 92500050; AF-14 Aquatherm Spa Pack 16-070-200B Diaclear AP-304D Doughboy 306-1002, 306-1005, 1128-1006 H & F Lomart 047-015, 047-016, 304 Marine 7700 For A Series Martec 300-009, 310-108 Polaris P-55 For Vac Sweep Premier 31-813 For 455/456, 500, 600 Series Purex P-28323 For Whisperflo; P-28050 Sta Rite U109-136SS For CF, CFA, HP Ser. Swimrite 60-828-813 Waterway 811-1001AB Wet Institute 34-050-311 (1000)</p>
<p>MS-406 TYPE: B SHAFT DIA.: 5/8" Marlow 26661, 26469</p>	<p>MS-372 TYPE: A SHAFT DIA.: 5/8" Hayward SPX0125-Z-2 Prior to 1967 Purex P-28128</p>	<p>MS-2131 TYPE: A SHAFT DIA.: 5/8" (INCLUDES PLASTIC HOUSING) Aqua Flo 91049000 For Flo Master, Tub Mstr. Baker Hydro 35131138, 35B1138 For Spa Pak Doughboy Power Pak II Gulf 341064702 For Power Tech II Hayward SPX1500-KA For PowerFlo, TurboFlo</p>
<p>MS-411 TYPE: B SHAFT DIA.: 5/8" Marlow 25353, 26467, 23636, 26661</p>	<p>MS-381 TYPE: C SHAFT DIA.: 1 1/4" Sta Rite U109-220 For CC, C, D Series</p>	
<p>MS-416A TYPE: C SHAFT DIA.: 1 1/4" Marlow 27223 For 3B Series</p>	<p>MS-406 TYPE: B SHAFT DIA.: 5/8" Marlow 26661, 26469</p>	

POPULAR PUMPS & SEAL CROSS REF.

FITS OEM	PUMP TYPE	FITS OEM#	SSC#	FITS OEM	PUMP TYPE	FITS OEM#	SSC#
American Products	Americana	395005	MS-201	Muskin	--	09-2001	MS-163
	Americana II	397012	MS-1000		--	09-2013	MS-142
	Bronze-Bronze	397020	MS-1000	Pac Fab	Challenger	35-4545	MS-200
	Bronze-Noryl	395005	MS-201		Dynamite	35-4545	MS-200
	Eagle	397012	MS-1000		Dynamo	35-4545	MS-200
	Eagle	397020	MS-1000		Dynatron	35-4545	MS-200
	Maxim	397012	MS-1000		Hydropump	35-4001	MS-201
	Power Glas	397012	MS-1000		Pinnacle	35-4545	MS-200
Ultra Flow	097020	MS-1000					
Ampro/Diaclear	Dia. Cast	AP-504D	MS-163	Polaris	Vac Sweep	P-55	MS-1000
	Dura Flo	AP-304D	MS-1000		120T Series	31-812	MS-201
	Lexan-200 Ser.	AP-504D	MS-163	220/225 Series	31-813	MS-1000	
	Noryl Turbo	AP-304D	MS-1000	Pre 1988			
	XL600	AP-304D	MS-1000	225/255 MKII	31-812	MS-201	
Anthony	--	04380	MS-1000	Premier	300 Series	31-813	MS-1000
	--	04547	MS-100		Pre 1988		
Aqua Flo	A Series	92509040	MS-1000		325/355 Series	31-812	MS-201
	A Series	92500050	MS-1000		455/456 Series	31-813	MS-1000
	B Series	92509040	MS-1000		500 Series	31-813	MS-1000
	C Series	92500050	MS-1000		600 Series	31-813	MS-1000
	D Series	92509040	MS-1000		725/756 Series	31-812	MS-201
	D Series	92500050	MS-1000		Purex	AH Series	P-28300
	Dominator-High	92500150	MS-200	Aquatron		P-28322	MS-501
	Pre-1995	92500050	MS-1000	C Series		P-28175	MS-360
	Dominator-Med.	92500150	MS-200	L Series		P-28300	MS-201
	Pre-1995	92500050	MS-1000	L Series		P-28280	MS-100
	Flo Master	91049000	MS-2131	Whisperflo	P-28323	MS-1000	
	Flo Master	92500150	MS-200				
	Tub Master	91049000	MS-2131	Richardson	E-Z Flo	--	MS-201
	Tub Master	92500150	MS-200				
Arneson	Pool Sweep	A-8	MS-200	Sonfarrel (Martec)	Pool Master	320-119	MS-201
Baker Hydro	--	35B1178	MS-200	Spa Master	300-009	MS-1000	
Diaclear	--	36100	MS-142	Sta Rite	AJ Series	U109-93SS	MS-100
Doughboy	--	306-1002	MS-1000		CC/C Series	U109-220	MS-381
	--	306-1006	MS-200		CF/CFA Series	U109-136SS	MS-1000
Hayward	Cast Iron	SPX1250X-Z-2	MS-200		D Series	U109-220	MS-381
	Max Flo	SPX1600-Z-2	MS-201		DJ/JS/JT Series	U109-358SS	MS-201
	Northstar	SPX1600-Z-2	MS-201		Dura Glas	17304-0100S	MS-200
	Power Flo	SPX1500-KA	MS-2131		Dura Glas-Pre '98	U109-93SS	MS-100
	Power Flo II	SPX1500-KA	MS-2131		Dura Glas II	U109-93SS	MS-201
	Super Pump	SPX1600-Z-2	MS-201		Dura Glas II-Pre '98	U109-372SS	MS-201
	Super II	SPX1600-Z-2	MS-201		Dura Jet	U109-358SS	MS-201
	Turbo Flo	SPX1500-KA	MS-2131		Dyna Glas/Max	U109-358SS	MS-201
Marlow	2 AF Series	25353-00	MS-411		Dyna Jet	17351-0101S	MS-201
	3B Series	27223-00	MS-416A		HP Series	U109-136SS	MS-1000
	Argonaut	38592-00	MS-201		JW/JWA5 Series	U109-358SS	MS-201
	Mardur	38592-00	MS-201		JWPA Series	U109-358SS	MS-201
					LT Series	U109-68SS	MS-163
					Max E Glas	17304-0100S	MS-200
Jacuzzi	8M	10-1203-01	MS-877	Max E Glas-Pre '98	U109-93SS	MS-100	
	Cygnnet	10-0002-01	MS-200	Max E Glas II	U109-358SS	MS-201	
	A Series	10-0002-06	MS-200	MaxEGlas II-Pre 98	U109-372SS	MS-201	
	J, JCM Series	10-0002-06	MS-200	PLBC Series	17351-102S	MS-100	
	K, KM Series	10-0002-06	MS-200	PLBC Ser-Pre-'95	U109-93SS	MS-100	
	LCM Series	10-1436-00	MS-200	Swimquip	XL, VI/XL, VII	AS-201	MS-201
	LCU Series	10-1436-00	MS-200	Vico	Ultima	PPSFSEAL	MS-201
	LR Series	10-0002-06	MS-200	Waterway	A.G./Spa	811-1001AB	MS-1000
	Magnum	10-1502-09	MS-201	WET Institute	WA	34-050-31	MS-1000
	RC Series	10-1502-09	MS-201	WMC	AT Series	SS-1600-Z-2	MS-201
Vector (LVL)	10-0002-06	MS-200	JS Series	JS-1702	MS-200		
Lomart	--	40-027	MS-163				
	--	40-029	MS-163				

PUMP REPAIR / SERVICE KITS

PUMP REPAIR/SERVICE KITS



SSC's Pump Repair and Service Kits make it quick and easy to service pumps. We eliminate the guesswork sometimes needed when getting the right parts together for pump repair or service. All kits include the necessary O-rings, gaskets and pump seals. Each kit's contents and application are clearly identified on the package. All are skin-packed for display.

AMERICAN PRODUCTS

R-6129

AMERICANA & BRONZE PUMP WITH NORYL IMPELLER

- G-5045 Seal Plate O-ring (1)
- MS-201 Pump Seal (1)
- O-2054 Lid O-ring (1)
- G-4409 Pot to Volute Gasket (1)
- O-2026 Volute O-ring (1)

R-6130

EAGLE PUMP

- O-2095 Volute O-ring (1)
- MS-1000 Pump Seal (1)
- O-2060 Lid O-ring (1)
- G-4284 Diffuser Gasket (1)

R-6149

MAXIM, AMERICANA II, POWER GLAS PUMPS

- MS-1000 Pump Seal (1)
- O-2079 Impeller O-ring (1)
- O-2066 Face Plate O-ring (1)
- O-2262 Volute O-ring (1)
- O-2218 Lid O-ring (1)
- G-4206 Water Slinger (1)

R-6143

ULTRA FLOW & BRONZE PUMP WITH BRONZE IMPELLER

- MS-1000 Pump Seal (1)
- O-2111 Diffuser Gasket (1)
- O-1082 Volute Gasket (1)
- G-4409 Pot to Volute Gasket (1)
- O-2054 Lid O-ring (1)
- O-2026 Volute O-ring (1)

R-6126

MULTIPOINT VALVE KIT BEFORE 1976

- G-5146 Teflon Backup O-ring (2)
- O-2133 Shaft O-ring (2)
- O-2410 Quad O-ring (1)
- G-5104 6 Spoke Gasket (1)

R-6127

UNIVERSAL SLIDE VALVE KIT FOR 1 1/2" & 2" BRONZE AND ABS

- G-3148 Valve Cap Gasket (1)
- O-2106 Valve Cap Body O-ring (1)
- O-2024 Stem & Shaft Cap O-ring (1)
- O-2115 Valve Cap O-ring (1)
- O-2068 Valve Piston O-ring (1)
- O-2126 Valve Stem O-ring (1)
- O-2142 Old Style Valve Piston O-ring (2)

R-6128

MULTIPOINT VALVE KIT AFTER 1976

- G-5146 Teflon Backup O-ring (2)
- O-2133 Shaft O-ring (2)
- O-2410 Quad O-ring (1)
- G-5105 5 Spoke Gasket (1)

ANTHONY

R-6111

2" PLASTIC SLIDE VLV-FITS #17810-17770

- O-2008 Piston O-ring (3)
- O-2024 Shaft O-ring (3)
- O-2106 Bulkhead Connector (2)

R-6112

UNIVERSAL SLIDE VALVE KIT FOR 1 1/2" & 2" BRONZE & ABS

- O-2008 Plastic Valve Piston O-ring (3)
- O-2024 Valve Shaft O-ring (3)
- O-2142 Piston Cap O-ring (3)
- O-2115 Piston Cap O-ring (3)
- O-2106 Plastic Vlv B/H Connector O-ring (2)

R-6154

1 1/2" BRASS SLIDE VALVE KIT

- O-2142 Piston O-ring (3)
- O-2024 Shaft O-ring (1)

AQUA FLO

R-6140

DOMINATOR HIGH & MEDIUM HEAD & C SERIES PUMP-BEFORE 1995

- MS-1000 Pump Seal (1)
- O-1082 Seal Plate O-ring (1)
- O-2226 Flange Volute O-ring (1)
- O-2128 Lid O-ring (1)
- O-2195 Diffuser O-ring (1)
- O-2067 Volute O-ring (1)

R-6145

DOMINATOR HIGH & MEDIUM HEAD AND XP SERIES PUMP-AFTER 1995

- MS-200 Pump Seal (1)
- O-1082 Seal Plate O-ring (1)
- O-2226 Flange Volute O-ring (1)
- O-2128 Lid O-ring (1)
- O-2195 Diffuser O-ring (1)
- O-2209 Volute O-ring For XP-D11 Series (1)

R-6141

FLO MASTER FMHP/FMCP/FMVP AND TUBMASTER YMCP/TMF

- MS-2131 Pump Seal (W/ Plastic Housing) (1)
- O-2262 Volute O-ring (1)
- O-2228 Lid O-ring (1)
- O-2025 Volute O-ring (1)
- O-2226 Flange O-ring (1)

R-6142

STANDARD A SERIES-5"

- MS-1000 Pump Seal (1)
- G-3256 Volute Gasket (1)
- G-3275 Trap Gasket (1)
- O-2228 Lid O-ring (1)

COLUMBIA

R-6153

BLUE SEAL ABOVE GROUND PUMP

- O-2128 Cover O-ring (1)
- MS-163 Pump Seal (1)

DOUGHBOY

R-6131

POWER PAK II PUMP

- MS-2131 Pump Seal (W/ Plastic Housing) (1)
- O-2104 Backplate O-ring-For Seal Hsng (1)
- O-2041 Diffuser O-ring (1)
- O-2286 Strainer Body O-ring (1)
- O-2231 O-ring (1)

R-6132

POWER PAK I, LOMART DYNAFLOW

- O-2119 Lid O-ring (1)
- MS-1000 Pump Seal (1)
- O-2017 Volute O-ring (1)
- O-2203 Basket Port O-ring (1)

HAYWARD

R-6106

CAST IRON PUMP-SP-1250 SERIES

- G-3128 Body Gasket (1)
- G-5039 Strainer Cover Gasket (1)
- G-5003 Diffuser Gasket (1)
- G-4227 Slinger (1)
- MS-200 Pump Seal (1)

R-6101

MAX FLO SERIES 1800-2800

- O-1209 Housing O-ring/Gasket (1)
- O-2618 Diffuser O-ring/Gasket (1)
- G-5039 Lid Gasket (1)
- MS-201 Pump Seal (1)

R-6104

POWERFLO PUMP-CLEAR COVER

- O-2152 Strainer Connector O-ring (1)
- G-3125 Pump Gasket-Fiber (1)
- O-2007 Pump Lid O-ring (1)
- MS-2131 Pump Seal (1)

R-6105

POWERFLO PUMP-SOLID COVER

- O-2152 Strainer Connector O-ring (1)
- G-3125 Pump Gasket-Fiber (1)
- O-2025 Valve Lid O-ring (1)
- MS-2131 Pump Seal (1)

R-6118

POWERFLO PUMP-1700 SERIES

- MS-2131 Pump Seal (1)
- MS-1000 Pump Seal (1)
- O-2143 Housing O-ring (1)
- O-2007 Strainer O-ring (1)
- O-2152 Strainer O-ring (1)

R-6103
SUPER PUMP-SERIES 1600, 2600, 2600X
 O-1209 Housing O-ring/Gasket (1)
 O-2618 Diffuser O-ring/Gasket (1)
 O-1226 Lid O-ring/Gasket (1)
 MS-201 Pump Seal (1)

R-6102
SUPER II PUMP-SERIES 3000-3000X
 O-2618 Diffuser O-ring/Gasket (1)
 O-2247 Pump Lid O-ring (1)
 O-1217 Housing O-ring/Gasket (1)
 MS-201 Pump Seal (1)

R-6117
TURBOFLO 2000-2100 & POWERFLO 1500 SERIES
 MS-2131 Pump Seal (1)
 G-4119 Housing Gasket-Rubber (1)
 O-2025 Strainer Cover O-ring (1)
 O-2007 Strainer Cover O-ring (1)
 O-2152 Strainer O-ring (1)
 O-2143 Housing O-ring (1)

R-6115
5 SPOKE MULTIPOINT REBUILD KIT-SPX710X/711
 G-5106 5 Spoke Gasket (1)
 O-2128 Cover O-ring (1)
 G-3277 Non-Metallic Bearing Gasket (1)
 O-2256 Stem O-ring (1)

R-6116
6 SPOKE MULTIPOINT REBUILD KIT-SPX710/711
 G-5108 6 Spoke Gasket (1)
 O-2025 Cover O-ring (1)
 O-2133 Shaft O-ring (1)
 G-5142 Teflon Washer (1)

R-6148
SPX410X SLIDE VALVE KIT
 O-2155 Bonnet O-ring (1)
 O-2135 Shaft O-ring (1)
 O-2150 Large Piston O-ring (1)
 O-2008 Small Piston O-ring (1)
 O-2165 Connector O-ring (1)

R-6158
CL200 CHLORINATOR KIT
 O-2511 Viton Cover O-ring (1)
 K-6003 Viton O-ring Kit (1)
 G-4267 Gasket (1)

JACUZZI

R-6164
8M & 10M PUMP
 MS-877 Pump Seal (1)
 G-4186 Rubber Pump Gasket (1)
 G-4434 Valve Pump Gasket (1)

R-6163
CYGNET PUMP
 MS-200 Pump Seal (1)
 O-2059 Lid O-ring (1)
 O-2024 O-ring (2)
 O-2300 Case O-ring (1)

R-6161
J, JCM, K & KM PUMPS
 MS-200 Pump Seal (1)
 O-2266 Pump Lid O-ring (1)

R-6167
LPH, LPC, LTPH, LH & LTH PUMPS
 MS-200 Pump Seal (1)
 G-5060 Pump Square Ring (1)
 O-2024 O-ring (2)
 O-2304 Lid O-ring (1)

R-6147
LR SERIES PUMP
 MS-200 Pump Seal (1)
 O-2059 Lid O-ring (1)
 O-2024 Plug O-ring (1)
 G-5060 Bracket to Case O-ring (1)

R-6119
MAGNUM PUMP
 MS-201 Pump Seal (1)
 O-2058 Case O-ring (1)
 O-2024 Plug O-ring (1)
 O-2224 Strainer O-ring (1)
 G-5031 Diff. Square Ring (1)

R-6168
P, PC, EP SERIES PUMPS
 MS-877 Pump Seal (1)
 O-2024 O-ring (2)
 G-5046 Diffuser Gasket (1)
 G-5035 Square Ring (1)
 G-5016 Square Case Ring (1)

R-6165
PH & UPH PUMPS
 MS-201 Pump Seal (1)
 O-2304 Lid O-ring (1)
 O-2024 O-ring (2)
 G-5046 Diffuser Gasket (1)

R-6160
PJM PUMP
 MS-877 Pump Seal (1)
 O-2247 Lid O-ring (1)
 G-4186 Rubber Pump Gasket (1)
 O-2054 Lid O-ring (1)
 G-4433 Flange Gasket (1)
 G-3176 Gasket (1)

R-6120
R AND RC SERIES PUMPS
 MS-201 Pump Seal (1)
 G-5016 Bracket/Case Square Ring (1)
 O-2024 Plug O-ring (2)
 G-5046 Diff. Square Ring (1)
 O-2041 Strainer O-ring (1)

R-6166
SLPH, SLTPH, LCU, LTCU, ULCU, LCM, L3 & L25 PUMPS
 MS-200 Pump Seal (1)
 O-2139 Lid O-ring (1)
 O-2024 O-ring (2)
 G-5060 Pump Square Ring (1)

R-6162
ULSB & ULSC PUMPS
 MS-877 Pump Seal (1)
 O-2266 Lid O-ring (1)
 G-4186 Rubber Pump Gasket (1)

PAC FAB

R-6108
CHALLENGER PUMP
 MS-200 Pump Seal (1)
 O-2015 Diffuser O-ring (1)
 G-5061 Housing Square Ring-New Sty. (1)
 O-2046 Housing O-ring-Old Style (1)
 O-2226 Strainer O-ring (1)
 O-2172 Lid O-ring (1)

R-6121
DYNAMO, DYNAMO II, DYNAMITE & DYNATRON PUMPS
 MS-200 Pump Seal (1)
 O-2040 Tank Side Ring (1)
 O-2139 Tank Lid O-ring(1) (Dynamo II Only)
 O-2195 Connection O-ring (2)
 O-2214 Bracket Diff. O-ring-Before'93 (1)
 O-2286 Bracket Diff. O-ring-After '93 (1)

R-6138
HYDRO PUMP
 O-2262 Volute O-ring (1)
 O-2106 Pot to Volute O-ring (1)
 O-2028 Lid O-ring (1)
 O-2080 New Style Lid O-ring (1)
 O-2172 Old Style Lid O-ring (1)
 MS-201 Pump Seal (1)

R-6139
PINNACLE PUMP
 O-2294 Seal Bracket O-ring (1)
 MS-200 Pump Seal (1)
 O-2409 Diffuser O-ring (1)
 O-2172 Lid O-ring (1)

R-6137
UNIVERSAL SLIDE VALVE KIT
 -- Retainer Clips (5)
 G-3271 Valve Cap Gasket (1)
 O-2090 Shaft O-ring (1)
 G-5112 Piston Seal (2)
 G-5114 Piston Seal (2)
 O-2068 Shaft O-ring (2)
 O-2124 Diverter O-ring (1)
 O-2040 Valve Cap O-ring (1)

R-6107
2" SLIDE VALVE REBUILD KIT
 O-2040 Cap O-ring (2)
 O-2090 Shaft O-ring (2)
 G-5114 Piston Gasket/O-ring (2)

PREMIER

R-6171
355/225 MK2 PUMP
 MS-201 Pump Seal (1)
 O-2195 Tailpiece O-ring (1)
 O-2024 Drain Plug O-ring (1)
 O-2228 Lid O-ring (1)
 O-2262 Volute O-ring (1)

PUMP REPAIR / SERVICE KITS

R-6146

555 NORYL

MS-1000 Pump Seal (1)
O-2226 Pot to Volute O-ring (1)
O-2189 Pot to Volute O-ring (1)
O-2228 Lid O-ring (1)
O-2209 Volute O-ring (1)

R-6170

756 SERIES PUMP

MS-201 Pump Seal (1)
O-1082 O-ring (1)
O-2167 Cover O-ring (1)
O-2195 1 1/2" Tailpiece O-ring (1)
O-2024 Shaft Extension O-ring (1)
O-2135 2" Tailpiece O-ring (1)

PUREX

R-6124

AQUATRON PUMP

MS-501 Pump Seal (1)
O-2041 Lid O-ring (1)
O-2209 Bracket to Volute Flange O-ring (1)

R-6123

C SERIES PUMP

O-1067 Lid O-ring (1)
G-4247 Pot to Volute Flange Gasket (1)
MS-360 Pump Seal (1)
O-2604 Bracket to Volute Flange Gask (1)

R-6122

L SERIES & AA SERIES PUMPS

O-2247 Lid O-ring (1)
G-3255 Pot to Volute Gasket (1)
G-3247 Bracket to Volute Flange Gasket (1)
MS-201 Pump Seal (1)
O-2138 Bracket to Volute O-ring (1)

R-6125

WHISPERFLO PUMP

O-2216 Seal Plate O-ring (1)
O-2103 Diffuser O-ring (1)
O-2208 Impeller O-ring (1)
MS-1000 Pump Seal (1)

STA RITE

R-6110

CAST IRON PUMP-PP1100-FITS ALL CK & CRA4 MODELS

G-4253 Water Slinger (1)
G-5034 Diffuser Ring (1)
G-3259 Volute Gasket (1)
O-2099 Cover O-ring (1)
MS-100 Pump Seal (1)

R-6136

CF/CF6 SERIES PUMPS

MS-1000 Pump Seal (1)
G-3256 Volute Gasket (1)
O-2167 Lid O-ring (1)
O-2218 Trap O-ring (1)

R-6109

DURA GLAS / MAXI GLAS PUMPS-P2RA

O-1082 Housing O-ring (1)
G-4411 Gasket (1)
O-2195 Diffuser O-ring (1)
O-2060 Lid O-ring (1)
MS-100 Pump Seal (1)

R-6144

DYNAGLAS & J SERIES PUMPS

MS-201 Pump Seal (1)
O-2002 Diffuser O-ring (1)
O-2247 Lid O-ring (1)
O-2266 Seal Plate O-ring-J Series (1)
O-2305 Seal Plate O-ring-Dynaglas (1)

R-6150

FLO TECH PUMP-AQUATOOLS

MS-201 Pump Seal (1)
G-4253 Water Slinger (1)
O-2002 Diffuser O-ring (1)
O-2247 Cover O-ring (1)
O-2305 Seal Plate O-ring (1)

R-6133

MAXI GLAS II & DURA GLAS II-P4E & P4EA PUMPS

O-2142 Seal Plate O-ring (1)
O-1082 Seal Plate Housing O-ring (1)
MS-201 Pump Seal (1)
O-2002 Diffuser O-ring (1)
O-2247 Lid O-ring (1)

R-6134

PE & PEA SERIES, P2R & P2RA, AJ SERIES PUMPS

MS-100 Pump Seal (1)
O-1082 Clamp O-ring (1)
O-2195 Diffuser O-ring (1)
G-3226 Seal Plate Gasket (1)

R-6135

UNIVERSAL SLIDE VALVE KIT-FITS ALL 1 1/2" & 2" VALVES FOR STA RITE, SWIMQUIP, BAKER HYDRO, PUREX AND HYDROTECH

O-2188 Valve Piston O-ring (3)
O-2280 Valve Cap O-ring (1)
O-2082 Index Plate O-ring (2)
O-2134 Valve Piston O-ring (3)
O-2010 Valve Piston O-ring (2)
O-2042 Valve Piston O-ring (3)
O-2004 Valve Piston O-ring (3)

WATERWAY

R-6155

48 FRAME PUMP

MS-1000 Pump Seal (1)
O-2025 Volute O-ring (1)
O-2172 Lid O-ring (1)
O-2024 Drain Plug O-ring (1)

R-6156

75-125-200 CYCLONE PUMP

MS-1000 Pump Seal (1)
O-2141 Drain Plug O-ring (1)
O-2172 Lid O-ring (1)
O-2041 Volute O-ring (1)

If the kit you need is not listed here, please let us know and we'll add it.

FILTER O-RING/GASKET KITS

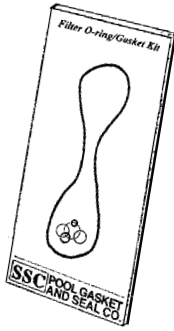

As with our pump kits, we have eliminated the guesswork sometimes needed when gathering parts to service cartridge, D.E. and sand filters. All Filter Kits include the necessary O-rings and gaskets and each kit's contents and application are clearly identified on the package. All are skin-packed for display.

AMERICAN

F-8316
CARTRIDGE FILTER-COMMANDER 4 & 6 OZ.-25, 35, 50, 75 & 100 SQ. FT.
 O-2090 Gauge Plug O-ring (1)
 O-2129 Knob Seal O-ring (1)
 O-1059 Tank O-ring (1)

F-8317
CARTRIDGE FILTER-QUANTUM 43.7 & 87.5 SQ. FT.
 O-2231 Drain Plug O-ring (1)
 O-1039 Tank O-ring (1)

F-8215
D.E. FILTER-TITAN-STAINLESS STEEL
 O-2106 Outlet Pipe O-ring (1)
 O-2231 Drain Plug O-ring (1)
 O-2040 Inlet Pipe O-ring (After 1/1/90) (1)
 O-1039 Tank O-ring (Before 1/1/90) (1)
 O-2106 Inlet Pipe O-ring (Before 1/1/90) (1)
 G-4237 Bulkhead Gasket (1)
 G-4278 Bulkhead Gasket (1)

F-8107
SAND FILTER-OLYMPIAN
 O-2106 Bulkhead O-ring (Before 1/1/91) (1)
 O-2040 Bulkhead O-ring (After 1/1/91) (1)
 O-2060 Lid O-ring (1)
 G-4237 Bulkhead Gasket (1)
 G-4278 Thin Gasket (1)

BAKER HYDRO

F-8324
CARTRIDGE FILTER-HYDRO MITE-25, 50, 75, 100, SQ. FT.
 G-5006 Lid O-ring/Gasket (1)

HAYWARD

F-8301
CARTRIDGE FILTER-SUPER STAR CLEAR 3000 & 4000-75, 100 SQ. FT.
 O-2133 Filter O-ring (1)
 O-2270 Filter O-ring (2)
 O-2165 Filter O-ring (2)
 O-1001 Tank O-ring (1)

F-8302
CARTRIDGE FILTER-STAR CLEAR II-75, 100, 150 SQ. FT.
 O-2116 Locking Knob O-ring (1)
 O-1054 Filter O-ring (1)
 O-2261 O-ring (1)

F-8303
CARTRIDGE FILTER-STAR CLEAR-25, 50, 75 SQ. FT.
 O-1215 Tank O-ring (1)
 O-2116 Locking Knob O-ring (1)
 O-2261 O-ring (1)

F-8304
CARTRIDGE FILTER-MICRO STAR CLEAR IN-LINE-12, 20, 25 SQ. FT.
 O-2095 Lid O-ring (1)
 G-5033 Elbow O-ring (1)

F-8305
CARTRIDGE FILTER-SUPER STAR CLEAR C-3000S & C-4000S STAINLESS STEEL TANK-75, 100 SQ. FT.
 O-2040 Base O-ring (1)
 O-2155 Inlet Elbow O-ring (1)
 O-2208 Air Relief Valve Stem O-ring (1)
 O-1099 Tank O-ring (1)
 O-2308 Air Relief Valve Stem O-ring (2)
 G-4212 Valve/Head Gasket (1)

F-8306
CARTRIDGE FILTER-STAR CLEAR PLUS-C900 & C1200-90, 120 SQ. FT.
 O-1082 Filter Head O-ring (1)
 O-2239 Knob O-ring (1)
 O-2261 Drain Plug O-ring (1)
 G-3277 Knob & Cone Washer (2)

F-8201
D.E. FILTER-PERFLEX-EC-65 & EC-75
 O-2135 Bump Shaft O-ring (1)
 G-5152 Diaphragm Gasket-No Holes (1)

F-8202
D.E. FILTER-MICRO CLEAR-VERTICLE GRID-STAINLESS STEEL
 O-2106 Outlet Elbow O-ring (1)
 O-2040 Support Base O-ring (1)
 O-1099 Tank O-ring (1)
 O-2208 Relief Valve O-ring (3)
 G-4212 Relief Valve to Filter Head Gask (1)

F-8203
D.E. FILTER-PERFLEX-EC-30,40, 50
 O-2135 Bump Shaft O-ring (1)
 G-5153 Diaphragm Gasket-w/ Holes (1)

F-8204
D.E. FILTER-MICRO CLEAR-VERTICLE GRID, DURALON & PERMAGLASS XL
 O-2106 Outlet Elbow O-ring (1)
 O-2208 Relief Valve Stem O-ring (1)
 O-2308 Relief Valve Stem O-ring (2)
 O-1001 Tank O-ring (1)

F-8101
SAND FILTER-GM SERIES-GM140, 142, 142-6, 152, 152HV
 O-2264 Drain Plug O-ring (1)
 O-2058 Valve Tank O-ring (1)
 O-2164 Valve Tank O-ring (1)

F-8102
SAND FILTER-PRO SERIES PLUS-S164T, S166T, S140T, S220T, S244T, S144T, S310T, S180T, S210T, S311X, S311SXV, S360SX, S210S, S220S, S244S, S310S
 O-2133 Air Relief Valve O-ring (1)
 O-2058 Valve Tank O-ring (1)
 O-2164 Valve Tank O-ring (1)
 G-4443 Drain Plug Gasket (1)

F-8103
SAND FILTER-160T
 O-2133 Drain Plug O-ring (Before 1980) (1)
 O-2261 Drain Plug O-ring (After 1980) (1)
 O-2091 Valve Head O-ring (1)
 O-1049 Tank O-ring (1)
 G-4325 Drain Plug Gasket (1)

F-8104
SAND FILTER-S-200
 O-2133 Air Relief O-ring (Before 1980) (1)
 O-2261 Drain Plug O-ring (After 1980) (1)
 O-1106 Tank O-ring (1)
 O-2091 Cap O-ring (1)
 G-4325 Drain Plug Gasket (1)

F-8105
SAND FILTER-S-240
 O-2133 Air Relief O-ring (Before 1980) (1)
 O-2261 Air Relief O-ring (After 1980) (1)
 O-2091 Cover O-ring (1)
 O-1044 Tank O-ring (1)
 G-4443 Drain Plug Gasket (1)

F-8106
SAND FILTER-S-245T & S-190T
 O-2058 Valve Tank O-ring (1)
 O-2261 Drain Plug O-ring (1)
 G-4325 Drain Plug Gasket (1)

JACUZZI

F-8315
CARTRIDGE FILTER-CFR SERIES-50, 75, 100, 150, 200 SQ. FT.
 O-2024 Stem & Crank O-ring (1)
 O-2181 Cover O-ring (1)

F-8314
CARTRIDGE FILTER-CFR 25 IN LINE-25 SQ. FT.
 O-2024 Stem & Crank O-ring (1)
 O-2095 Lid O-ring (1)

FILTER O-RING / GASKET KITS

F-8322

CARTRIDGE FILTER-TRI-CLOPS & EARTHWORK-75, 150 SQ. FT.

O-2024 Air Relief O-ring (1)
O-2165 Bottom O-ring (1)
O-2264 Manifold Knob O-ring (1)
O-1015 Tank O-ring (1)

F-8216

D.E. FILTER-LANDSLIDE & SEPARATION TANK

O-2024 Drain Plug O-ring (1)
O-2143 Support O-ring (1)
O-2181 Tank & Cover O-ring (1)

F-8218

D.E. FILTER-EARTHWORKS ONLY

O-2024 O-ring (1)
O-1015 Tank O-ring (1)
O-2264 Valve Shaft O-ring (1)

F-8114

SAND FILTER-LASER-160L, 190L, 225L, 250L, LR3, LR6, MFM15

O-2024 Drain Plug O-ring (1)
O-2080 Flange O-ring (1)
G-5023 Adapter Flange Gasket (1)

F-8119

SAND FILTER-MFM 17, 20, 24

G-5023 Valve Gasket (1)
O-2024 O-ring (1)
O-2058 Bottom Drain O-ring (1)

F-8120

SAND FILTER-RMST-24, ST27, ST33

O-2098 Filter Lid O-ring (1)
O-2293 Valve to Adapter O-ring (1)
O-1101 Valve Lid O-ring (1)
O-2134 Drain Plug O-ring (1)

PAC FAB

F-8308

CARTRIDGE FILTER-MYTILUS & MITRA-50, 80, 100 SQ. FT.

O-2141 Gauge & Air Bleeder Adptr O-ring (1)
O-1048 Tank O-ring (1)

F-8309

CARTRIDGE FILTER-MITRA-60 SQ. FT.

O-2141 Gauge & Air Bleeder Adptr O-ring (1)
O-1070 Tank O-ring (1)

F-8310

CARTRIDGE FILTER-MYTILUS FMY FIBERGLASS-80, 100, 150 SQ. FT. & MYTILUS FIBERGLASS REINFORCED POLYMERIC 60, 80, 100 SQ. FT.

O-2141 Adapter O-ring (1)
O-2002 Bulkhead Adapter O-ring (2)
O-1048 Tank O-ring (1)
O-2282 Bulkhead O-ring (1)
G-4324 Bulkhead Diff. Gasket (1)

F-8311

CARTRIDGE FILTER-MYTILUS FIBER-GLASS REINFORCED POLYMERIC-60, 80, 100 SQ. FT.

O-2141 Air Bleeder O-ring (1)
O-1048 Tank O-ring (1)
O-2115 Small Bottom Piping O-ring (1)
O-2071 Large Bottom Piping O-ring (1)

F-8312

CARTRIDGE FILTER-MITRA STAINLESS STEEL-60, 80, 100 SQ. FT.

O-2141 Air Bleeder O-ring (1)
O-2002 Bulkhead Adapter O-ring (2)
O-2282 2" Bulkhead O-ring (1)
O-1070 Tank O-ring (1)
G-4324 Bulkhead Diff. Gasket (1)

F-8211

D.E. FILTER-STAR FIBERGLASS REINFORCED POLYMERIC

O-1048 Tank O-ring (1)
O-2115 Small Bottom Center Pipe O-ring (2)
O-2071 Large Bottom Center Pipe O-ring (1)
O-2256 Shaft O-ring (1)
O-2189 Gauge O-ring (1)

F-8212

D.E. FILTER-SM/SMBW 4000 SERIES

O-2124 Rotor Valve O-ring (1)
O-1029 Tank O-ring (1)

F-8217

D.E. FILTER-NAUTILUS STAINLESS STEEL

O-2106 Filter Pump O-ring (1)
O-1062 Tank O-ring (1)
O-2002 Bulkhead Valve Adapter O-ring (1)
O-2302 Bleeder Cartridge Filter O-ring (1)

F-8214

SAND FILTER-2000 SERIES, COLLECTOR & BACK WASH VALVE WITH BRASS & NORYL ROTOR

O-2124 Rotor Shaft O-ring (1)
O-2165 Collar Rotor O-ring (3)
O-2220 Brass Rotor O-ring (1)
O-2214 Valve Body O-ring (1)
O-2226 Collar Rotor O-ring (1)

F-8108

SAND FILTER-FIBERGLASS

O-2141 Air Bleeder Adapter O-ring (1)
O-2041 Closure O-ring (1)
O-2082 Drain Plug O-ring (1)
O-2282 Drain Plug & Bulkhead O-ring (1)
G-4324 Bulkhead Gasket (1)

F-8110

SAND FILTER-PF & 35/50 STAINLESS STEEL

O-2100 1 1/2" Bulkhead O-ring (1)
O-2141 Air Bleeder O-ring (1)
O-2282 2" Bulkhead O-ring (1)
O-1062 18" Tank O-ring (1)
O-1056 22" Tank O-ring (1)
G-4296 Bulkhead Gasket (1)

F-8111

SAND FILTER-PF-100 STAINLESS STEEL

O-2141 Air Bleeder O-ring (1)
O-2282 2" Bulkhead O-ring (1)
O-1071 16" Tank O-ring (1)
G-4324 2" Bulkhead Gasket (1)

F-8112

SAND FILTER-TAGLEUS FIBERGLASS-TA30D, TA35D, TA40D, TA50D, TA60D, TA100D, TA30, TA35, TA40, TA50, TA60

O-2041 Valve Body & Valve Adptr O-ring (2)
O-2082 Drain Plug O-ring (1)
O-2091 Valve Body O-ring (1)
O-2189 Standpipe O-ring (1)
O-2226 Standpipe O-ring (1)
O-2294 Valve Adapter O-ring (1)
O-2292 Valve Body O-ring (1)

PUREX

F-8307

CARTRIDGE FILTER-CF-25 & CF-150-25, 150 SQ. FT.

O-1063 Lid O-ring (1)

F-8109

SAND FILTER-TAHITIAN HI RATE

O-2165 Valve Collar O-ring (1)
O-2221 Rotor Shaft O-ring (1)

RAINBOW

F-8325

CARTRIDGE FILTER-3 & 4 OZ.-25, 50 SQ. FT.

O-2135 Valve O-ring (1)
O-2095 Lid O-ring (1)

STA RITE

F-8318

CARTRIDGE FILTER-POSI FLO-35, 50 SQ. FT.

O-1010 Tank O-ring (1)

F-8319

CARTRIDGE FILTER-POSI FLO II-70, 100 SQ. FT.

O-1010 Tank O-ring (1)
O-2046 Lid O-ring (1)

F-8320

CARTRIDGE FILTER-POSI FLO EARLY & LATE MODELS-135 SQ. FT.

O-2024 Air Release O-ring (1)
O-1010 Tank O-ring (1)
G-5061 Lid O-ring (1)

F-8321

CARTRIDGE FILTER-TXC25, TXC25B, TXC50, TXC50B, TXC75, TXC100

O-2102 Knob O-ring (1)
O-1215 Lid & Base O-ring (1)

F-8205

D.E. FILTER-VERTICLE-DEP36, HRP20, HRP20-01B

- O-2100 Cap O-ring (1)
- O-1106 Tank O-ring (1)
- O-2403 Outlet Elbow O-ring (1)

F-8206

D.E. FILTER-VERTICLE-DEP51, HRP24, HRP24-01B

- O-2100 Cap O-ring (1)
- O-1009 Tank O-ring (1)
- O-2403 Outlet Elbow O-ring (1)

F-8207

D.E. FILTER-VERTICLE-DEP83, HRP30, HRP30-01B

- O-2100 Cap O-ring (1)
- O-1046 Tank O-ring (1)
- O-2403 Outlet Elbow O-ring (1)

F-8208

D.E. AND SAND FILTER-VERTICLE-DES25, HRS16-01

- O-1133 Tank O-ring (1)

F-8209

D.E. AND SAND FILTER-VERTICLE-DES36, HRS20-01

- O-1015 Tank O-ring (1)

F-8210

D.E. AND SAND FILTER-VERTICLE-DES51, DES60, HRS24-01

- O-1002 Tank O-ring (1)

F-8116

SAND FILTER-HIGH RATE-36"

- G-5006 Lid O-ring (1)
- G-5058 Bulkhead O-ring (1)

F-8117

SAND FILTER-PANTERA, PANTERA SKID SYSTEM & T-HRP

- G-5012 Valve Tank Square Ring (1)

F-8118

SAND FILTER-SEPARATION TANK ASSEMBLY-415SW-820SW (DISCONTINUED IN 1992)

- O-1048 Tank O-ring (1)

If the kit you need is not listed here, please let us know and we'll add it.

WATERWAY

F-8326

CARTRIDGE FILTER-TOP LOAD

- O-2095 Lid O-ring (1)
- O-2133 Air Bleeder O-ring (1)

GAUGES

PRESSURE, VACUUM & COMPOUND GAUGES

SSC's gauges are constructed with a steel case painted black, all brass internals and a glass lens. Competitively priced, the styles to choose from are pressure, vacuum or compound.

LM = LOWER MOUNT
CBM = CENTER BACK MOUNT

PRESSURE GAUGES

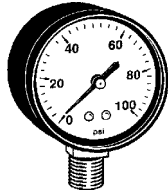

INDIVIDUALLY BOXED

SSC#	DIAL SIZE	MOUNT	PRESSURE
102902	1"	1/8" CBM	30
102903	1"	1/8" CBM	60
102904	1"	1/8" CBM	100
102905	1"	1/8" CBM	160
102907	1"	1/8" CBM	300
102921	1 1/2"	1/8" LM	15
102922	1 1/2"	1/8" LM	30
102923	1 1/2"	1/8" LM	60
102924	1 1/2"	1/8" LM	100
102925	1 1/2"	1/8" LM	160
102926	1 1/2"	1/8" LM	200
102927	1 1/2"	1/8" LM	300
103001	1 1/2"	1/8" CBM	15
103002	1 1/2"	1/8" CBM	30
102991	1 1/2"	1/8" CBM	60
103003	1 1/2"	1/8" CBM	100
102992	1 1/2"	1/8" CBM	160
102993	1 1/2"	1/8" CBM	200
103004	1 1/2"	1/8" CBM	300
102994	1 1/2"	1/8" CBM	400
102995	1 1/2"	1/8" CBM	600
103022	2"	1/8" LM	15
103023	2"	1/8" LM	30
103024	2"	1/8" LM	60
103025	2"	1/8" LM	100
103026	2"	1/8" LM	160
103027	2"	1/8" LM	200
103028	2"	1/8" LM	300
103029	2"	1/8" LM	400
103013	2"	1/4" LM	15
103014	2"	1/4" LM	30
103015	2"	1/4" LM	60
103016	2"	1/4" LM	100
103017	2"	1/4" LM	160
103018	2"	1/4" LM	200
103019	2"	1/4" LM	300
103020	2"	1/4" LM	400
103021	2"	1/4" LM	600
103031	2"	1/8" CBM	15
103032	2"	1/8" CBM	30
103033	2"	1/8" CBM	60
103034	2"	1/8" CBM	100
103035	2"	1/8" CBM	160

SSC#	DIAL SIZE	MOUNT	PRESSURE
103036	2"	1/8" CBM	200
103037	2"	1/8" CBM	300
103039	2"	1/8" CBM	600
103041	2"	1/4" CBM	15
103008	2"	1/4" CBM	30
103009	2"	1/4" CBM	60
103010	2"	1/4" CBM	100
103042	2"	1/4" CBM	160
103011	2"	1/4" CBM	200
103012	2"	1/4" CBM	300
103043	2"	1/4" CBM	400
103044	2"	1/4" CBM	600
103104	2 1/2"	1/4" LM	15
103105	2 1/2"	1/4" LM	30
103106	2 1/2"	1/4" LM	60
103107	2 1/2"	1/4" LM	100
103108	2 1/2"	1/4" LM	160
103109	2 1/2"	1/4" LM	200
103110	2 1/2"	1/4" LM	300
103111	2 1/2"	1/4" LM	400
103112	2 1/2"	1/4" LM	600
103099	2 1/2"	1/4" CBM	15
103100	2 1/2"	1/4" CBM	30
103101	2 1/2"	1/4" CBM	60
103102	2 1/2"	1/4" CBM	100
103120	2 1/2"	1/4" CBM	160
103121	2 1/2"	1/4" CBM	200
103122	2 1/2"	1/4" CBM	300
103123	2 1/2"	1/4" CBM	400
103124	2 1/2"	1/4" CBM	600
103200	3 1/2"	1/4" LM	15
103202	3 1/2"	1/4" LM	30
103203	3 1/2"	1/4" LM	60
103204	3 1/2"	1/4" LM	100
103205	3 1/2"	1/4" LM	160
103206	3 1/2"	1/4" LM	200
103207	3 1/2"	1/4" LM	300
103208	3 1/2"	1/4" LM	400
103209	3 1/2"	1/4" LM	600
103201	3 1/2"	1/4" CBM	30
103221	3 1/2"	1/4" CBM	60
103222	3 1/2"	1/4" CBM	100
103223	3 1/2"	1/4" CBM	160
103224	3 1/2"	1/4" CBM	200
103225	3 1/2"	1/4" CBM	300
103226	3 1/2"	1/4" CBM	400
103227	3 1/2"	1/4" CBM	600
103301	4 1/2"	1/4" LM	15
103302	4 1/2"	1/4" LM	30
103303	4 1/2"	1/4" LM	60
103304	4 1/2"	1/4" LM	100
103305	4 1/2"	1/4" LM	160
103306	4 1/2"	1/4" LM	200
103307	4 1/2"	1/4" LM	300
103308	4 1/2"	1/4" LM	400
103309	4 1/2"	1/4" LM	600
103322	4 1/2"	1/4" CBM	30
103323	4 1/2"	1/4" CBM	60
103324	4 1/2"	1/4" CBM	100
103325	4 1/2"	1/4" CBM	160
103326	4 1/2"	1/4" CBM	200
103327	4 1/2"	1/4" CBM	300

VACUUM GAUGES



INDIVIDUALLY BOXED

SSC#	DIAL SIZE	MOUNT	VACUUM
104990	1 1/2"	1/8" LM	30
104991	1 1/2"	1/8" CBM	30
105002	2"	1/8" LM	30
105001	2"	1/4" LM	30
105003	2"	1/8" CBM	30
105004	2"	1/4" CBM	30
105011	2 1/2"	1/4" LM	30
105012	2 1/2"	1/4" CBM	30

COMPOUND GAUGES



INDIVIDUALLY BOXED

SSC#	DIAL SIZE	MOUNT	VAC / PRESS
101951	1 1/2"	1/8" LM	30 / 30
101961	1 1/2"	1/8" CBM	30 / 30
102000	2"	1/8" LM	30 / 30
102001	2"	1/8" LM	30 / 60
102002	2"	1/8" LM	30 / 150
102003	2"	1/8" LM	30 / 300
101971	2"	1/4" LM	30 / 30
101972	2"	1/4" LM	30 / 60
101973	2"	1/4" LM	30 / 150
101974	2"	1/4" LM	30 / 300
101991	2"	1/8" CBM	30 / 30
101992	2"	1/8" CBM	30 / 60
101993	2"	1/8" CBM	30 / 150
101994	2"	1/8" CBM	30 / 300
101981	2"	1/4" CBM	30 / 30
101982	2"	1/4" CBM	30 / 60
101983	2"	1/4" CBM	30 / 150
101984	2"	1/4" CBM	30 / 300
102011	2 1/2"	1/4" LM	30 / 30
102012	2 1/2"	1/4" LM	30 / 60
102013	2 1/2"	1/4" LM	30 / 150
102014	2 1/2"	1/4" LM	30 / 300
102021	2 1/2"	1/4" CBM	30 / 30
102022	2 1/2"	1/4" CBM	30 / 60
102023	2 1/2"	1/4" CBM	30 / 150
102024	2 1/2"	1/4" CBM	30 / 300
102031	3 1/2"	1/4" LM	30 / 30
102032	3 1/2"	1/4" LM	30 / 60
102033	3 1/2"	1/4" LM	30 / 150

PLASTIC CASE GAUGES

Our plastic case gauges are corrosion and weather resistant. They can be used in extreme environmental situations such as outdoor use or very wet areas where a standard gauge might rust. These economical gauges are constructed with a plastic case, a plastic lens and all brass internals.

PLASTIC CASE PRESSURE GAUGES

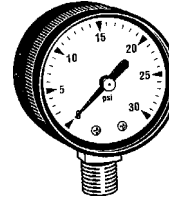

INDIVIDUALLY BOXED

SSC#	DIAL SIZE	MOUNT	PRESSURE
103013PL	2"	1/4" LM	15
103014PL	2"	1/4" LM	30
103015PL	2"	1/4" LM	60
103016PL	2"	1/4" LM	100
103017PL	2"	1/4" LM	160
103018PL	2"	1/4" LM	200
103019PL	2"	1/4" LM	300
103041PL	2"	1/4" CBM	15
103008PL	2"	1/4" CBM	30
103009PL	2"	1/4" CBM	60
103010PL	2"	1/4" CBM	100
103042PL	2"	1/4" CBM	160
103011PL	2"	1/4" CBM	200
103012PL	2"	1/4" CBM	300

PLASTIC CASE VACUUM GAUGES

105001PL	2"	1/4" LM	30VAC
105004PL	2"	1/4" CBM	30VAC

GAUGES

LIQUID (GLYCERIN) FILLED GAUGES

SSC's glycerin filled gauges are good for applications where there is a lot of movement. The liquid inside the gauge acts as a vibration and pulsation damper, thus giving the technician a more accurate read. They are constructed with a stainless steel case, a plastic lens and all brass internals.

LM = LOWER MOUNT
CBM = CENTER BACK MOUNT

LIQUID FILLED PRESSURE GAUGES



INDIVIDUALLY BOXED

SSC#	DIAL SIZE	MOUNT	PRESSURE
100301	1 1/2"	1/8" LM	15
100302	1 1/2"	1/8" LM	30
100303	1 1/2"	1/8" LM	60
100304	1 1/2"	1/8" LM	100
100305	1 1/2"	1/8" LM	160
100306	1 1/2"	1/8" LM	200
100307	1 1/2"	1/8" LM	300
100310	1 1/2"	1/8" CBM	15
100311	1 1/2"	1/8" CBM	30
100312	1 1/2"	1/8" CBM	60
100313	1 1/2"	1/8" CBM	100
100314	1 1/2"	1/8" CBM	160
100315	1 1/2"	1/8" CBM	200
100316	1 1/2"	1/8" CBM	300
100318	1 1/2"	1/8" CBM	600
100332	2"	1/8" LM	30
100333	2"	1/8" LM	60
100334	2"	1/8" LM	100
100335	2"	1/8" LM	160
100336	2"	1/8" LM	200
100337	2"	1/8" LM	300
100339	2"	1/8" LM	600
100340	2"	1/4" LM	15
100341	2"	1/4" LM	30
100342	2"	1/4" LM	60
100343	2"	1/4" LM	100
100344	2"	1/4" LM	160
100345	2"	1/4" LM	200
100346	2"	1/4" LM	300
100348	2"	1/4" LM	600
100350	2"	1/8" CBM	30
100351	2"	1/8" CBM	60
100352	2"	1/8" CBM	100
100353	2"	1/8" CBM	160
100354	2"	1/8" CBM	200
100355	2"	1/8" CBM	300
100357	2"	1/8" CBM	600
100358	2"	1/4" CBM	15
100359	2"	1/4" CBM	30
100360	2"	1/4" CBM	60
100361	2"	1/4" CBM	100
100362	2"	1/4" CBM	160
100363	2"	1/4" CBM	200

SSC#	DIAL SIZE	MOUNT	PRESSURE
100364	2"	1/4" CBM	300
100366	2"	1/4" CBM	600
100381	2 1/2"	1/4" LM	15
100382	2 1/2"	1/4" LM	30
100383	2 1/2"	1/4" LM	60
100384	2 1/2"	1/4" LM	100
100385	2 1/2"	1/4" LM	160
100386	2 1/2"	1/4" LM	200
100387	2 1/2"	1/4" LM	300
100388	2 1/2"	1/4" LM	400
100389	2 1/2"	1/4" LM	600
100390	2 1/2"	1/4" CBM	15
100391	2 1/2"	1/4" CBM	30
100392	2 1/2"	1/4" CBM	60
100393	2 1/2"	1/4" CBM	100
100394	2 1/2"	1/4" CBM	160
100395	2 1/2"	1/4" CBM	200
100396	2 1/2"	1/4" CBM	300
100397	2 1/2"	1/4" CBM	400
100398	2 1/2"	1/4" CBM	600
100410	4"	1/4" LM	15
100411	4"	1/4" LM	30
100412	4"	1/4" LM	60
100413	4"	1/4" LM	100
100414	4"	1/4" LM	160
100415	4"	1/4" LM	200
100416	4"	1/4" LM	300
100417	4"	1/4" LM	400
100418	4"	1/4" LM	600
100419	4"	1/4" CBM	15
100420	4"	1/4" CBM	30
100421	4"	1/4" CBM	60
100422	4"	1/4" CBM	100
100423	4"	1/4" CBM	160
100424	4"	1/4" CBM	200
100425	4"	1/4" CBM	300
100426	4"	1/4" CBM	400
100427	4"	1/4" CBM	600

LIQUID FILLED VACUUM GAUGES

100460	1 1/2"	1/8" LM	30VAC
100461	1 1/2"	1/8" CBM	30VAC
100462	2"	1/8" LM	30VAC
100463	2"	1/4" LM	30VAC
100464	2"	1/8" CBM	30VAC
100465	2"	1/4" CBM	30VAC
100466	2 1/2"	1/4" LM	30VAC
100467	2 1/2"	1/4" CBM	30VAC
100468	4"	1/4" LM	30VAC
100469	4"	1/4" CBM	30VAC

Liquid Filled Compound Gauges start on next page...

LIQUID FILLED COMPOUND GAUGES

SSC#	DIAL SIZE	MOUNT	VAC / PRESS.
100105	1 1/2"	1/8" CBM	30 / 30
100125	2"	1/4" LM	30 / 30
100126	2"	1/4" LM	30 / 60
100127	2"	1/4" LM	30 / 150
100150	2 1/2"	1/4" LM	30 / 30
100151	2 1/2"	1/4" LM	30 / 60
100152	2 1/2"	1/4" LM	30 / 150
100153	2 1/2"	1/4" LM	30 / 300
100154	2 1/2"	1/4" CBM	30 / 30
100155	2 1/2"	1/4" CBM	30 / 60
100156	2 1/2"	1/4" CBM	30 / 150
100157	2 1/2"	1/4" CBM	30 / 300
100170	4"	1/4" LM	30 / 30
100171	4"	1/4" LM	30 / 60
100172	4"	1/4" LM	30 / 150
100173	4"	1/4" LM	30 / 300
100174	4"	1/4" CBM	30 / 30
100175	4"	1/4" CBM	30 / 60
100176	4"	1/4" CBM	30 / 150
100177	4"	1/4" CBM	30 / 300

ADAPTER FITTING

Use this handy adapter to convert 1/4" mount gauges to 1/8" mount.



106875
GAUGE ADAPTER
FITTING
 Brass
 1/4" Female to 1/8" Male

NEEDLE VALVES

SSC's needle valves are handy to use when leaving gauges on equipment. Open the valve to test pressure and turn off when not in use.



FIP x FIP

BRASS

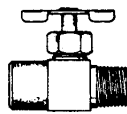

FIP x MIP

SSC#	SIZE
122040	1/8" FIP x 1/8" FIP
122042	1/4" FIP x 1/4" FIP
122046	1/8" FIP x 1/8" MIP
122048	1/4" FIP x 1/8" MIP

WATER TEST GAUGES



INDIVIDUALLY BOXED

106001
WATER TEST GAUGE
 2 1/2" Dial Size
 3/4" Female Garden Hose
 Connection; 0-300 PSI
 Made of all brass internals,
 brass fitting, plastic body and
 plastic lens.

WITH LAZY HAND

The regular pressure hand pushes the lazy hand to the peak operating or surge pressure point where it remains until you manually reset it. The lazy hand comes in handy when you have to determine if equipment is malfunctioning due to intermittent surging pressure.



INDIVIDUALLY BOXED

106002
WATER TEST GAUGE
WITH LAZY HAND
 2 1/2" Dial Size
 3/4" Female Garden Hose
 Connection; 0-300 PSI
 Made of all brass internals,
 brass fitting, plastic body
 and plastic lens.

BRASS ADAPTER FOR WATER TEST GAUGE

Use this adapter to turn any gauge you have on hand temporarily into a water test gauge.



106005
BRASS ADAPTER FOR
WATER TEST GAUGE
 3/4" Female Garden Hose
 Connection X 1/4" Female
 Fitting

GASKET SHEETS

GASKET SHEETS

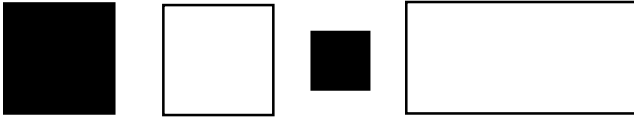

Available in various thicknesses, SSC's gasket sheets are perfect for emergency repairs and for replacing hard to find gaskets and washers. All materials can be cut into any shape or size. Available in the following materials and sizes:

CORK-RUBBER

The highest quality material of its kind, it can be used to seal applications involving oil or water. It will not shrink, stretch or lose bolt tension.

SSC#	SIZE
GS-1A	6" x 6" x 1/32" TH
GS-1B	6" x 6" x 1/16" TH
GS-1C	12" x 12" x 1/32" TH
GS-1D	12" x 12" x 1/16" TH
GS-1E	24" x 24" x 1/32" TH
GS-1F	24" x 24" x 1/16" TH
GS-1G	20" x 40" x 1/32" TH
GS-1H	20" x 40" x 1/16" TH

BUNA-N RUBBER

This black rubber is ideal for sealing oil applications. It has a high nitrile content which means it is oil resistant.

SSC#	SIZE
GS-2A	6" x 6" x 1/32" TH
GS-2B	6" x 6" x 1/16" TH
GS-2C	6" x 6" x 3/32" TH
GS-2D	6" x 6" x 1/8" TH
GS-2E	12" x 12" x 1/32" TH
GS-2F	12" x 12" x 1/16" TH
GS-2G	12" x 12" x 3/32" TH
GS-2H	12" x 12" x 1/8" TH
GS-2I	24" x 24" x 1/32" TH
GS-2J	24" x 24" x 1/16" TH
GS-2K	24" x 24" x 3/32" TH
GS-2L	24" x 24" x 1/8" TH
GS-2M	20" x 36" x 1/32" TH
GS-2N	20" x 36" x 1/16" TH
GS-2P	20" x 36" x 3/32" TH
GS-2Q	20" x 36" x 1/8" TH

RED RUBBER (RAINBOW PACKING)

The most popular rubber for sealing water applications, it can be used on everything from pipe flanges to pump housings. Not to be put in contact with any petroleum product.

SSC#	SIZE
GS-3A	6" x 6" x 1/16" TH
GS-3B	6" x 6" x 1/8" TH
GS-3C	12" x 12" x 1/16" TH
GS-3D	12" x 12" x 1/8" TH
GS-3E	12" x 24" x 1/8" TH
GS-3F	18" x 36" x 1/8" TH
GS-3G	24" x 24" x 1/16" TH
GS-3H	24" x 24" x 1/8" TH
GS-3I	20" x 36" x 1/16" TH

TAN FIBER (FOR OIL)

This has been used successfully in the oil industry for over 20 years. It will seal oil or water.

SSC#	SIZE
GS-4A	6" x 6" x 1/32" TH
GS-4B	6" x 6" x 1/16" TH
GS-4C	12" x 12" x 1/32" TH
GS-4D	12" x 12" x 1/16" TH
GS-4E	24" x 24" x 1/32" TH
GS-4F	24" x 24" x 1/16" TH
GS-4G	20" x 40" x 1/32" TH
GS-4H	20" x 40" x 1/16" TH

TAN FIBER (FOR OIL) WITH ADHESIVE BACKING

Same as material above except with adhesive backing for a secure fit.

SSC#	SIZE
GS-4I	6" x 6" x 1/32" TH
GS-4J	12" x 12" x 1/32" TH
GS-4K	24" x 24" x 1/32" TH
GS-4L	20" x 40" x 1/32" TH

HIGH DENSITY CORK-RUBBER

This high grade material can be used in oil or water applications. It forms to imperfections on the flange and is very durable.

SSC#	SIZE
GS-5A	6" x 6" x 1/32" TH
GS-5B	12" x 12" x 1/32" TH
GS-5C	24" x 24" x 1/32" TH
GS-5D	20" x 36" x 1/32" TH

TAN FIBER (FOR WATER)

This fiber material is designed to be used in applications involving the sealing of water. Especially good for pump housings and flanges. Not to be used in oil applications.

SSC#	SIZE
GS-6A	6" x 6" x 1/32" TH
GS-6B	6" x 6" x 1/16" TH
GS-6C	12" x 12" x 1/32" TH
GS-6D	12" x 12" x 1/16" TH
GS-6E	24" x 24" x 1/32" TH
GS-6F	24" x 24" x 1/16" TH
GS-6G	20" x 40" x 1/32" TH
GS-6H	20" x 40" x 1/16" TH

BLACK FIBER

This material for higher temperatures can be used in oil or water. It is frequently used for applications like steam and hot water.

SSC#	SIZE
GS-7A	6" x 6" x 1/32" TH
GS-7B	6" x 6" x 1/16" TH
GS-7C	12" x 12" x 1/32" TH
GS-7D	12" x 12" x 1/16" TH
GS-7E	24" x 24" x 1/32" TH
GS-7F	24" x 24" x 1/16" TH
GS-7G	20" x 40" x 1/32" TH
GS-7H	20" x 40" x 1/16" TH

BLACK FIBER WITH ANTI-STICK COATING

Same as black fiber except with the added feature of anti-stick coating. This allows easy removal from flanges.

SSC#	SIZE
GS-8A	6" x 6" x 1/32" TH
GS-8B	6" x 6" x 1/16" TH
GS-8C	12" x 12" x 1/32" TH
GS-8D	12" x 12" x 1/16" TH
GS-8E	24" x 24" x 1/32" TH
GS-8F	24" x 24" x 1/16" TH
GS-8G	20" x 40" x 1/32" TH
GS-8H	20" x 40" x 1/16" TH

NON-ASBESTOS

This is the most popular material used for pipe flange gaskets and gaskets used in higher pressure applications. Excellent with water but not with oil/petroleum product.

SSC#	SIZE
GS-9A	6" x 6" x 1/16" TH
GS-9B	6" x 6" x 1/8" TH
GS-9C	12" x 12" x 1/16" TH
GS-9D	12" x 12" x 1/8" TH
GS-9E	24" x 24" x 1/16" TH
GS-9F	24" x 24" x 1/8" TH
GS-9G	20" x 36" x 1/16" TH
GS-9H	20" x 36" x 1/8" TH

NEOPRENE

This black rubber is the most popular rubber in the world. Automobile tires are made of neoprene. Very effective in sealing water, it will not dry out or harden as fast as Red Rubber. Do not use this rubber in oil/petroleum product as it will swell up and then break down.

SSC#	SIZE
GS-10A	6" x 6" x 1/32" TH
GS-10B	6" x 6" x 1/16" TH
GS-10C	6" x 6" x 3/32" TH
GS-10D	6" x 6" x 1/8" TH
GS-10E	6" x 6" x 3/16" TH
GS-10F	6" x 6" x 1/4" TH
GS-10G	12" x 12" x 1/32" TH
GS-10H	12" x 12" x 1/16" TH
GS-10I	12" x 12" x 3/32" TH
GS-10J	12" x 12" x 1/8" TH
GS-10K	12" x 12" x 3/16" TH
GS-10L	12" x 12" x 1/4" TH
GS-10M	24" x 24" x 1/32" TH
GS-10N	24" x 24" x 1/16" TH
GS-10P	24" x 24" x 3/32" TH
GS-10Q	24" x 24" x 1/8" TH
GS-10R	24" x 24" x 3/16" TH
GS-10S	24" x 24" x 1/4" TH
GS-10T	20" x 36" x 1/32" TH
GS-10U	20" x 36" x 1/16" TH
GS-10V	20" x 36" x 3/32" TH
GS-10W	20" x 36" x 1/8" TH
GS-10X	20" x 36" x 3/16" TH
GS-10Y	20" x 36" x 1/4" TH
GS-10TA	12" x 24" x 1/8" TH
GS-10TB	12" x 24" x 1/4" TH
GS-10TC	18" x 36" x 1/8" TH
GS-10TD	18" x 36" x 1/4" TH

EPDM

The "Cadillac" of rubber, this black rubber will withstand higher heat and tends not to dry out or harden in extreme environments. This is the material of choice for higher heat steam application such as boiler handhole and manhole gaskets.

SSC#	SIZE
GS-11A	6" x 6" x 1/8" TH
GS-11B	6" x 6" x 1/4" TH
GS-11C	12" x 12" x 1/8" TH
GS-11D	12" x 12" x 1/4" TH
GS-11E	24" x 24" x 1/8" TH
GS-11F	24" x 24" x 1/4" TH
GS-11G	20" x 36" x 1/8" TH
GS-11H	20" x 36" x 1/4" TH
GS-11J	12" x 24" x 1/8" TH
GS-11K	12" x 24" x 1/4" TH
GS-11L	18" x 36" x 1/8" TH
GS-11M	18" x 36" x 1/4" TH

GASKET SHEETS / O-RING CORD

RED EPDM

This rubber has the same properties as black EPDM except it is a much softer material. Good for higher temperature applications where the flange surface is flat or pitted.

SSC#	SIZE
GS-12A	6" x 6" x 3/32" TH
GS-12B	12" x 12" x 3/32" TH
GS-12C	24" x 24" x 3/32" TH
GS-12D	20" x 36" x 3/32" TH

WHITE BUNA-N RUBBER

This material has the same properties as the black Buna-N. It is a high grade material and will not stain equipment.

SSC#	SIZE
GS-14A	6" x 6" x 3/32" TH
GS-14B	12" x 12" x 3/32" TH
GS-14C	24" x 24" x 3/32" TH
GS-14D	20" x 36" x 3/32" TH

FIBERGLASS SHEETS

This high temperature material (good to 1000°F) is perfect for most gasketing or insulating applications involving boilers and furnaces.

SSC#	SIZE
GS-15A	6" x 6" x 1/8" TH
GS-15B	12" x 12" x 1/8" TH
GS-15C	17" x 24" x 1/8" TH
GS-15D	17" x 36" x 1/8" TH

ALUMINIZED HIGH TEMPERATURE CLOTH

Rated at 2300°, this material is excellent as a thermal barrier. It is used primarily as a **flame shield** when welding or soldering.

SSC#	SIZE
GS-18A	6" x 6" x 1/32" TH
GS-18B	12" x 12" x 1/32" TH
GS-18C	24" x 24" x 1/32" TH
GS-18D	20" x 36" x 1/32" TH

GASKET CUTTING SHEARS

These high leverage shears give you extra powerful cutting power to make gasket cutting easy, especially when working with thick material.



GS-100SH
HEAVY-DUTY SHEARS
FOR CUTTING GASKET
MATERIAL
Made of Hot Drop Forged
Nickel-Plated Steel

FULL ROLLS OF RED RUBBER (RAINBOW PACKING)

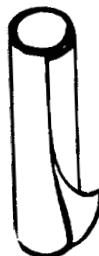

GS-3Y
1/16" THICK RED RUBBER
RAINBOW PACKING
100 lb Roll

GS-3Z
1/8" THICK RED RUBBER
RAINBOW PACKING
100 lb Roll

FULL ROLLS OF NEOPRENE RUBBER



GS-10TX
1/16" THICK
NEOPRENE RUBBER
100 lb Roll

GS-10TY
1/8" THICK
NEOPRENE RUBBER
100 lb Roll

FULL ROLLS OF BUNA-N RUBBER

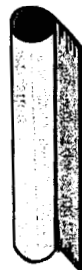

GS-2Y
1/16" THICK
BUNA-N RUBBER
100 lb Roll

GS-2Z
1/8" THICK
BUNA-N RUBBER
100 lb Roll

O-RING CORD

Priced by the foot, O-ring cord is handy to have in case you have to make emergency O-rings in the field.



SSC#	DIAMETER	SSC#	DIAMETER
OC-7000	1/16"	OC-7006	5/16"
OC-7000A	3/32"	OC-7008	3/8"
OC-7001	1/8"	OC-7010	7/16"
OC-7001A	5/32"	OC-7012	1/2"
OC-7002	3/16"	OC-7014	.535"
OC-7004	1/4"	OC-7016	9/16"
OC-7005	9/32"		

O-RING GUIDE/SHAFT EXT./MOTOR PARTS

O-RING CORD INSTANT ADHESIVE

Use this adhesive to bond together O-rings. It's good to have on hand in case you don't have the right O-ring in stock. Sold in 3 gram tubes.



OCAD-7025
O-RING CORD
INSTANT ADHESIVE
3 Gram Tube

LAMINATED O-RING SIZING GUIDE

Use this guide to identify any loose O-rings you have lying around. The guide is laminated for protection and all O-rings are shown life size with the SSC number clearly marked.

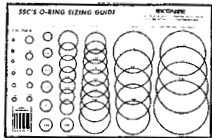

ORG-1
LAMINATED O-RING
SIZING GUIDE
8 Pages

PUMP / MOTOR SHAFT EXTENSIONS

SSC's pump shaft extensions are made of solid brass which ensures durability in a harsh environment. Stainless steel set screws are included and some shafts may fit pumps other than the ones listed.



E-6501
AMERICAN (397013)

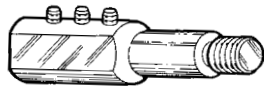

E-6502
PREMIER; AQUA-FLO AF6;
STA RITE (C110-17)

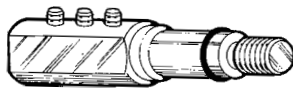

E-6503
SWIMRITE; PREMIER P-8,
104, 475 (31-814);
POLARIS P-45



E-6504
PAC FAB (35-3750)

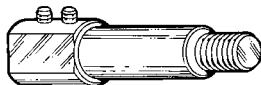

E-6505
JACUZZI (07-3610-09)

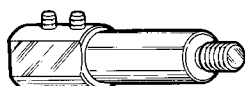

E-6506
SWIMQUIP (16800-29)



E-6510
SET SCREW FOR
SHAFT EXTENSION
Stainless Steel

MOTOR PARTS TO FIT A.O. SMITH

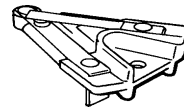

301100
STATIONARY SWITCH
Single Speed

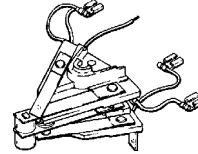

301102
STATIONARY SWITCH
Two Speed

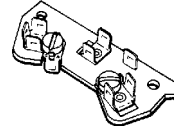

301104
TERMINAL BOARD

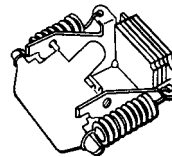

301106
ROTATING SWITCH
Single Speed

301108
ROTATING SWITCH
Two Speed

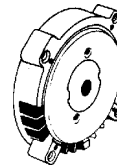

301112
S.E. END BELL-
ROUND BODY
Uses 203 Bearing

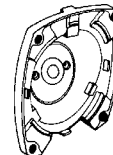

301114
S.E. END BELL-
SQUARE FLANGE
Uses 203 Bearing

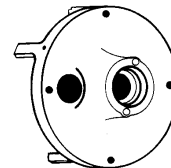

301118
O.S.E. END BELL
Uses 203 Bearing

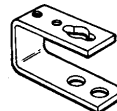

301120
BRACKET

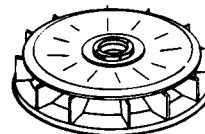

301124
INTERNAL COOLING FAN
21/32" ID x 4 3/4" OD

301122
INTERNAL COOLING FAN
25/32" ID x 4 3/4" OD
(SHOWN)

301126
INTERNAL COOLING FAN
21/32" ID x 4 11/16" OD

MOTOR PARTS FOR CENTURY / G.E.

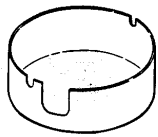

301128
BACK COVER

MOTOR PARTS TO FIT CENTURY

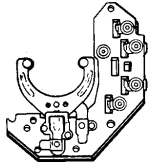

301200
STATIONARY SWITCH
Single Speed

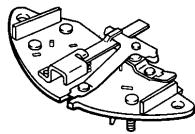

301202
STATIONARY SWITCH
Single Speed

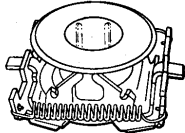

301204
ROTATING SWITCH
Single Speed

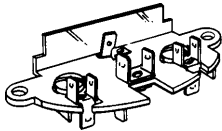

301206
TERMINAL BOARD
PSC Design



301208
S.E. END BELL-
ROUND BODY
Uses 304 Bearing

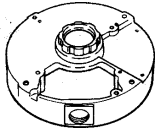

301212
O.S.E. END BELL
Uses 203 Bearing



301214
TERMINAL BOARD COVER

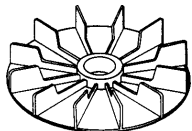

301216
INTERNAL COOLING FAN
21/32" ID x 4 3/4" OD

MOTOR PARTS TO FIT GENERAL ELECTRIC

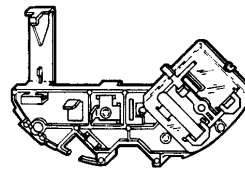

301300
STATIONARY SWITCH
Single Speed

301302
STATIONARY SWITCH
Two Speed

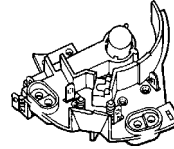

301306
STATIONARY SWITCH
Two Speed

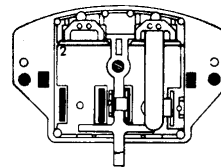

301308
STATIONARY SWITCH
Single Speed

301310
STATIONARY SWITCH
Two Speed

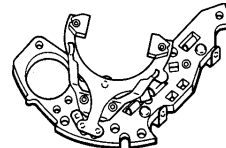

301312
STATIONARY SWITCH
Single Speed

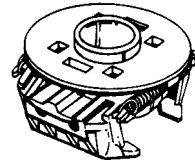

301316
ROTATING SWITCH
Single Speed

301318
ROTATING SWITCH
Two Speed

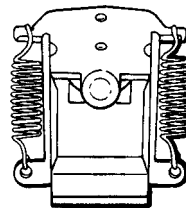

301320
ROTATING SWITCH
Single Speed

301322
ROTATING SWITCH
Two Speed

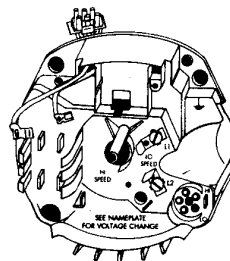

301324
BASE PLATE-INCLUDES
QUICK DISCONNECT
PLUG AND TERMINALS
Single Speed

301326
BASE PLATE-INCLUDES
QUICK DISCONNECT
PLUG AND TERMINALS
Two Speed

MOTOR CAPACITORS / MOTOR THRU BOLTS



301328
VOLTAGE CHANGE PLUG

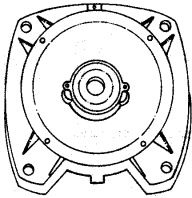

301330
S.E. END BELL-
SQUARE FLANGE
Uses 203 Bearing

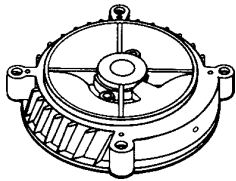

301334
S.E. END BELL-
ROUND BODY
Uses 203 Bearing

301336
S.E. END BELL-
ROUND BODY
Uses 204 Bearing

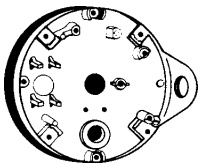

301338
O.S.E. END BELL
Uses 203 Bearing

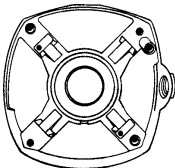

301340
O.S.E. END BELL
Uses 203 Bearing

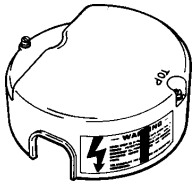

301342
BACK COVER-2 SCREWS
Single Speed

301344
BACK COVER-2 SCREWS
Two Speed

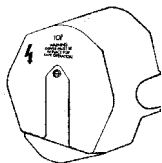

301346
BACK COVER-
SINGLE SCREW

MOTOR THRU BOLTS

SSC's motor thru bolts will fit most A.O. Smith, Century and General Electric pool pump motors. All bolts are made of 302 stainless steel to resist corrosion and they can be cut to the specific length needed.

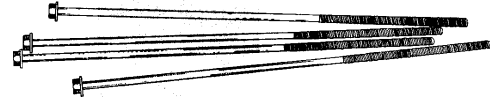

SSC#	DESCRIPTION
301400	8-32 x 9" Long x 3" Thread
301402	8-32 x 12" Long x 2" Thread
301404	10-32 x 9" Long x 3" Thread
301406	10-32 x 12" Long x 3" Thread

MOTOR START AND RUN CAPACITORS

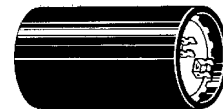

START CAPACITORS

125 Volt AC - 60 Cycle

SSC#	MFD	DIAMETER	HEIGHT
MC-510	72-78	1 7/16"	2 3/4"
MC-511	88-108	1 7/16"	2 3/4"
MC-512	108-130	1 7/16"	2 3/4"
MC-513	124-149	1 7/16"	2 3/4"
MC-514	145-175	1 7/16"	2 3/4"
MC-515	161-193	1 7/16"	2 3/4"
MC-516	189-227	1 7/16"	2 3/4"
MC-517	200-240	1 7/16"	2 3/4"
MC-518	243-292	1 7/16"	2 3/4"
MC-519	270-324	1 7/16"	2 3/4"
MC-520	324-388	1 13/16"	2 3/4"
MC-521	340-408	1 13/16"	3 3/8"
MC-522	378-440	1 13/16"	3 3/8"
MC-523	400-480	1 13/16"	3 3/8"
MC-524	460-552	1 13/16"	3 3/8"
MC-525	540-648	1 13/16"	3 3/8"

RUN CAPACITORS

370 Volts - Round
Metallized Film - Motor Run

SSC#	MFD	DIAMETER	HEIGHT
MC-540	25	1 3/4"	2 7/8"
MC-541	30	1 3/4"	2 7/8"

BALL BEARINGS / TOOLS

BALL BEARINGS

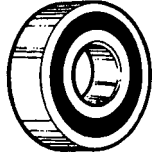

SSC's single row deep groove ball bearings have double, non-contact seals with a high temperature lubricant. They provide quiet, long-life performance with minimum vibration for most electric motors.

SSC#	I.D. (BORE)	OD	WIDTH
6202	.591" 15mm	1.378" 35mm	.433" 11mm
6202 Will Fit: Older Westinghouse and G.E. motors for above ground pumps, especially Lomart and Ampro.			
6202-16	.629" 16mm	1.378" 35mm	.433" 11mm
6202-16 Will Fit: New Westinghouse and G.E. motors for above ground pumps.			
6203	.669" 17mm	1.574" 40mm	.472" 12mm
6203 Will Fit: A.O. Smith, G.E., Century, etc. motors for below ground pumps. For Hayward, Jacuzzi, Marlow and others.			
6203-625	.625" 15.875mm	1.574" 40mm	.472" 12mm
6203-625 Will Fit: Emerson motors since 1974. Also for some above ground pumps such as Lomart.			
6204	.787" 20mm	1.854" 47mm	.551" 14mm
6205	.984" 25mm	2.047" 52mm	.590" 15mm
6206	1.181" 30mm	2.440" 62mm	.629" 16mm
6207	1.378" 35mm	2.834" 72mm	.669" 17mm
6303	.669" 17mm	1.854" 47mm	.551" 14mm
6304	.787" 20mm	2.047" 52mm	.590" 15mm
6304 Will Fit: This heavy duty bearings fits many modern motors.			

MOTOR BEARING PULLER

This is a special two armed puller designed to fit behind all pool motor bearings, eliminating the need for bearing puller adapters.

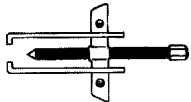

ST-377
MOTOR BEARING PULLER

ARMATURE HOLDING TOOL

This tool holds old style Century and Franklin armatures so the impeller can be removed. It fits into a 5/8" socket wrench.

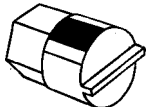

ST-375
ARMATURE HOLDING TOOL

SHAFT PULLER

Our Shaft Puller allows for easy removal of seal shaft extensions from keyed shaft pump motors. Can be used on Sta Rite, H&F, Pac Fab, American, Premier, Aqua Flo and Anthony motors.

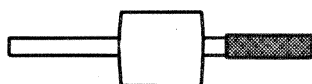

ST-376
SHAFT PULLER

CLOSED IMPELLER WRENCH



ST-362
CLOSED IMPELLER WRENCH
Fits all closed impellers. It has a large handle for leverage

OPEN IMPELLER WRENCH



ST-361
OPEN IMPELLER WRENCH
Fits all open-faced impellers

IMPELLER WEDGE

This tool was designed especially for spa booster pumps. It prevents the impeller from moving as you unscrew the impeller by turning the motor armature counter clockwise.

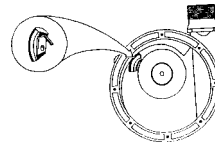

ST-378
IMPELLER WEDGE

SLICK PICK IMPELLER CLEANER

This efficient device allows the service technician to reach the closed impeller face without disassembling the entire pump. Simply turn off the pump and remove the pump lid and lint basket. Insert the opened "pick" and probe for debris using the wire end.



ST-371
"SLICK PICK"
IMPELLER CLEANER

"SLICKERY" SEAL EXTRACTION TOOL

This tool is designed to remove and install the MS-1000 type seal and the impeller on most brass pumps. It combines an impeller wrench with a modified piece of steel made exclusively for removing and installing the MS-1000 seals without the bracket out of the motor. Accomplishes in seconds what used to take ten minutes or more.

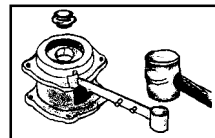

ST-368
SLICKERY SEAL
REMOVAL TOOL

"EYE-CATCHER" EYEBALL REMOVAL TOOL

This tool removes and installs the 1 1/2" grooved eyeball (circulation directing nozzles) with very little difficulty. Made of forged steel, it makes burdensome eyeball removal a snap.



ST-369
EYE-CATCHER EYEBALL
REMOVAL TOOL

TOOLS / TEFLON PRODUCTS

"COVERUP" BASKET COVER OPENING TOOL

This tool allows you to lift and open covers for pool equipment, electrical, plumbing and more. No more getting bitten by spiders and other insects living under the cover. It also saves your fingers from bruises, scratches and other injuries which often occur when lifting stubborn covers by hand. Attaches to your belt for convenience.

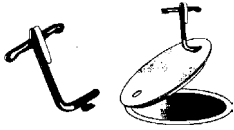

ST-370
"COVERUP" BASKET
COVER OPENING TOOL

O-RING PULLER TOOL

Save those fingers! This inexpensive tool makes O-ring removal fast and easy.

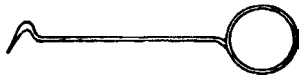

O-10950
O-RING PICK

BRASS CLEANING BRUSH



SSC-78BR
BRASS CLEANING BRUSH
Hickory Handle
Toothbrush Size

GASKET CUTTING SHEARS

These shears make gasket cutting easy, especially when working with thick material. The design also allows for an accurate cut.



GS-100SH
HEAVY-DUTY SHEARS FOR
CUTTING GASKET MATERIAL

PVC WIRE SAW

The PVC wire saw is perfect for tight spots (only needs 1/4" clearance) and quick cuts. It easily cuts through water-filled pipes.

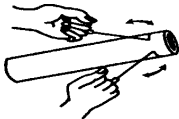

ST-365
PVC WIRE SAW

LIGHT WEDGE

This handy tool holds the pool light in when the niche tab is stripped or broken.

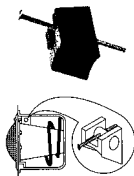

ST-374
LIGHT WEDGE
Made of corrosion
resistant polypropylene
with a stainless steel screw.

MAGNETIC POLE TIP

Use this tool to pick up bobby pins and other metal objects that are too small to be scooped up by your net and that would otherwise cause ugly, hard-to-remove rust stains.

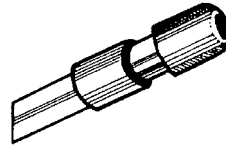

ST-372
MAGNETIC POLE TIP
Made of durable plastic
with a built-in ceramic
magnet. Will not corrode.

TEFLON TAPE

REGULAR TEFLON TAPE



.003" THICK

SSC#	SIZE
TT-312	3/4" X 520"
TT-314	1" X 520"
TT-315	1/2" X 260"
TT-316	1/2" X 520"

YELLOW GAS SEAL TEFLON TAPE

Our Yellow Gas Seal Teflon Tape is UL approved, has 1.6" density and is .004" thick. This extra heavy duty tape is made especially for natural gas, propane, butane, water, oil and chemical lines.



.004" THICK

SSC#	SIZE
TT-324	1/2" X 260"
TT-325	1/2" X 520"
TT-326	3/4" X 520"

TEFLON PASTE (PIPE DOPE)



TT-319
TEFLON PASTE
(PIPE DOPE)
1/2 Pint With Brush Top

TEFLON LUBRICANT

The U.S.D.A. has rated this lubricant as Food Grade Acceptable. Safely lubricate O-rings, seals, bearings, valves, gears, faucet components and more. This is a waterproof, non-melting, pure synthetic grease which will seal out water and lubricate under the most adverse conditions.



3 OZ. TUBE

LUB-985
TEFLON LUBRICANT/
SEALANT
U.S.D.A. H-1 Rated

LUBRICANTS / DUCT TAPE

SILICONE LUBRICANT

SSC's Silicone Lube has similar uses as the teflon lube except that it is silicone based, making it a higher grade product than the teflon. It is also rated as Food Grade Acceptable by the U.S.D.A.

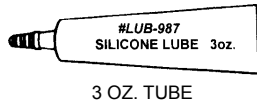

3 OZ. TUBE

LUB-987
SILICONE LUBRICANT/
SEALANT
U.S.D.A. H-1 Rated

GASKET REMOVING SOLUTION

Make the removal of stubborn, baked-on gaskets easy. With this product's foaming action you can remove gaskets without the work and without damage to the part. Sold in 18 oz. spray cans.

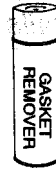

GR-957
GASKET REMOVING
SOLUTION
18 oz. Spray Can

SILICONE BASED SPRAY LUBRICANT

A coating of this food-grade rated spray lubricant will protect everything from O-rings to nuts and bolts. The superior and safe lubrication properties of silicone are packaged here in a spray for a cleaner and easier application.



4 OZ. SPRAY
BOTTLE

LUB-989
SILICONE BASED
SPRAY LUBRICANT

DUCT TAPE

GRAY

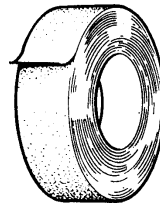

DT-317
GRAY COLORED
DUCT TAPE
2" x 60yds.
Each Roll is
Shrink-Wrapped
For Protection

BLACK



DT-320
BLACK COLORED
DUCT TAPE
2" x 50 yds.
Each Roll is
Shrink-Wrapped
For Protection

ZOOM-SPOUT OILER

Use the high quality turbine oil in SSC's Zoom-Spout Oiler to oil electric motors, heaters, blowers, bushings, shafts, air-conditioners and home and shop appliances. The handy telescoping pole reaches into hard-to-get places.



ZM-322
ZOOM-SPOUT OILER
4oz. Tubes With
Zoom-Spout

ALUMINUM FOIL TAPE

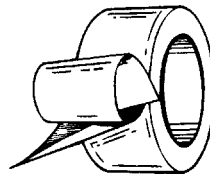

EACH ROLL IS
SHRINK-WRAPPED
FOR PROTECTION

SSC#	SIZE
DT-318	2" W x 50 yds.
DT-318A	3" W x 60 yds.

STICKY SPRAY

Sticky Spray is a convenient way to hold O-rings and gaskets in place during installation. Spray the surface where you are installing the part, wait 1-2 minutes until it becomes tacky and apply the part. The part can easily be separated from the surface at a later date. This product works especially well in troublesome installations such as putting spoke gaskets in multiport valves or cover gaskets in Hayward Super Pumps.



LUB-990
STICKY SPRAY
4oz. Spray Bottle

FIBERGLASS TAPE KIT- USED TO REPAIR PIPES & HOSES

Use our tape kit to repair broken pipe and hose. Just add water to the tape and wrap the broken area of pipe. Let it cure and the hole is patched. Rated at 300+ psi, -60° F to 800° F. It can be used on all types of pipe--plastics, poly, metal and copper.

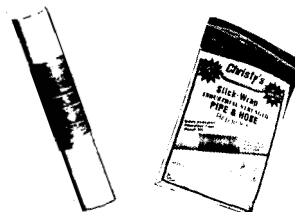

SW-350
FIBERGLASS TAPE
PIPE & HOSE
REPAIR KIT
2" Wide x 60" Long

SERVICE ACCESSORIES

DISPOSABLE VINYL GLOVES



PACKED 100/BOX

Our vinyl disposable gloves are an economical way to protect the hands from dirt, grease and other harmful chemicals while working in the field. They can be thrown out after each job or used over and over.

GL-627
DISPOSABLE VINYL
GLOVES
Medium Size

GL-628
DISPOSABLE VINYL
GLOVES
Large Size

DUST MASKS

Use these economical dust masks for protection against chemicals and undesirable odors while servicing pools and spas or while doing general service work.



PACKED 50/BOX

108510
DUST/PARTICLE MASK

ROUGH SERVICE BULBS

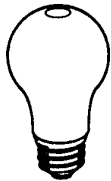

PACKED 4/PACKAGE

LB-608A
ROUGH SERVICE BULB
75 Watt

LB-608B
ROUGH SERVICE BULB
100 Watt

RUBBER GROMMETS

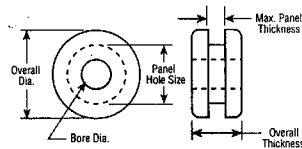

SSC#	BORE DIA.	PANEL HOLE/THICK.	DIA./THICK.
RG-634A	1/8"	1/4" / 1/16"	11/32" / 3/16"
RG-634B	3/16"	5/16" / 1/16"	1/2" / 1/4"
RG-634C	3/16"	5/16" / 3/16"	7/16" / 5/16"
RG-634D	5/16"	7/16" / 1/16"	5/8" / 9/32"
RG-634E	1/2"	1/2" / 1/16"	5/8" / 1/4"
RG-634F	3/8"	3/4" / 3/32"	7/8" / 11/32"
RG-634G	5/8"	7/8" / 1/16"	1 1/8" / 5/16"
RG-634H	3/4"	1 1/16" / 1/16"	1 3/8" / 3/8"
RG-634I	7/8"	1 1/4" / 1/16"	1 5/8" / 7/16"

RUBBER TIE DOWN STRAPS

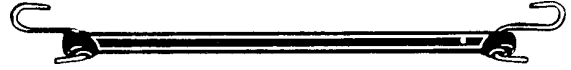

MADE OF EPDM RUBBER FOR MAXIMUM DURABILITY

SSC#	LENGTH
RS-629A	10"
RS-629B	15"
RS-629C	20"
RS-629D	31"
RS-629E	41"

VIBRO-INSULATORS

Vibro-Insulators are rubber mountings which reduce or prevent the travel of vibrations to or from machinery. They control vibration and reduce noise on electric motors, pumps, compressors, blowers, generators, etc.



VI-633D

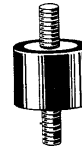

VI-633E



VI-633G

SSC#	DESCRIPTION
VI-633A	DOUBLE STUD-1 5/8" DIA.x1 1/2" Hx5/16-18 THR
VI-633B	DOUBLE STUD-1 5/8" DIA.x1"Hx5/16-18 THREAD
VI-633C	DOUBLE FEMALE-1" DIA.x1"Hx5/16-18-24 THR.
VI-633D	DOUBLE STUD-1"DIA.x1"Hx5/16-18 THREAD
VI-633E	DOUBLE STUD-1"DIA.x3/4"Hx1/4-20 THREAD
VI-633F	SINGLE STUD-1 5/8" DIA.x1 1/2"H x5/16-18 THR.
VI-633G	SINGLE STUD-1 5/8" DIA.x1"Hx5/16-18 THREAD

WIRE TIES AND MOUNTS

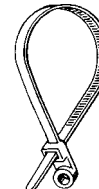
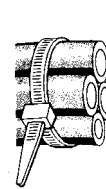

PACKED 100/BAG

SSC#	DESCRIPTION	LENGTH	STRENGTH
WT-625A	WHITE WIRE TIE	4"	18 LBS.
WT-625B	BLACK WIRE TIE	4"	18 LBS.
WT-625C	WHITE WIRE TIE	8"	18 LBS.
WT-625D	BLACK WIRE TIE	8"	18 LBS.
WT-625E	WHITE WIRE TIE	8"	50 LBS.
WT-625F	BLACK WIRE TIE	8"	50 LBS.
WT-625G	WHITE WIRE TIE	12"	50 LBS.
WT-625H	BLACK WIRE TIE	12"	50 LBS.
WT-625I	MNTG WIRE TIE-WH.	8 1/2"	50 LBS.
WT-625J	MNTG WIRE TIE-BL.	8 1/2"	50 LBS.
WT-625K	WIRE TIE MOUNT	3/4"	--
WT-625L	WIRE TIE MOUNT	1"	--
WT-625M	WHITE WIRE TIE	14"	40 LBS.
WT-625N	BLACK WIRE TIE	14"	40 LBS.
WT-625P	WHITE WIRE TIE	28 1/4"	120 LBS.
WT-625R	BLACK WIRE TIE	28 1/4"	120 LBS.

LADDER FOOT BUMPER / LADDER PARTS

LADDER FOOT BUMPER AND KIT

SSC's Ladder Foot Bumper is made of white rubber formulated to withstand the elements. The universal design will fit all major pool ladders.

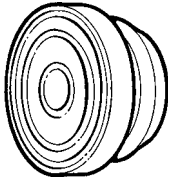

LFB-100
MALE LADDER
FOOT BUMPER
White Rubber

LADDER FOOT BUMPER KIT

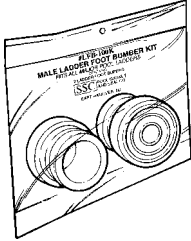

LFB-100K
2-PACK OF LADDER
FOOT BUMPERS
Packed in plastic bag
with hanger hole and
label for display.

HANDRAIL STABILIZING PLUGS

ANCHOR TYPE

When hammered into crushed handrails, it provides a permanent, strong supporting surface for the anchor to tighten against.

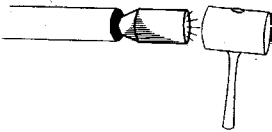

ST-363
HANDRAIL STABILIZING
PLUG-ANCHOR TYPE
Sold by Set

FIGURE 4 TYPE

When tapped into the jig it prevents the jig from collapsing and creates a solid area to tighten the nut and bolt against.



ST-364
HANDRAIL STABILIZING
PLUG-FIGURE 4 TYPE
Sold by Set

LADDER REPLACEMENT PARTS

ALUMINUM WEDGE ANCHOR

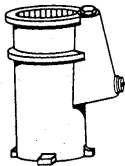

LP-250
WEDGE ANCHOR
SOCKET
4 Inch Aluminum
(Uses Wedge #LP-255)

BRONZE WEDGE ANCHOR

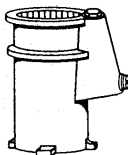

LP-251
WEDGE ANCHOR
SOCKET
4 Inch Bronze
(Uses Wedge #LP-255)

IN GROUND FLANGE ANCHOR

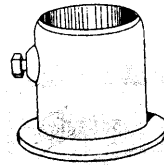

LP-260
LADDER FLANGE
ANCHOR
Aluminum
For 1.9" Rail (In Ground)
Hanover #: 24

ABOVE GROUND FLANGE ANCHOR

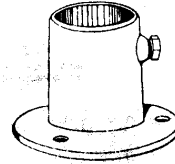

LP-261
LADDER FLANGE
ANCHOR
Aluminum
For 1.5" Rail (Above Ground)
Hanover #: 22

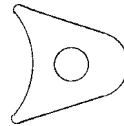

LP-255
WEDGE ASSEMBLY
With Bolt & Washer
Hanover #: 40

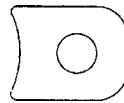

LP-256
WEDGE ASSEMBLY
With Bolt & Washer
Hanover #: 30



LP-257
WEDGE ASSEMBLY
With Bolt & Washer
For Perma Socket

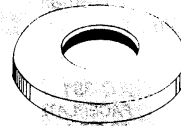

LP-266
ROUND ESCUTCHEON
White Plastic
Fits 1.9" Rail

LP-265
ROUND ESCUTCHEON
Stainless Steel
Fits 1.9" Rail

LP-267
ROUND ESCUTCHEON
Chrome Plated Plastic
Fits 1.9" Rail

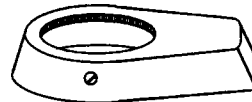





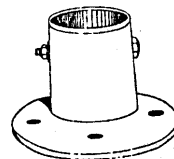



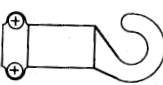
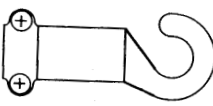



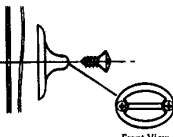
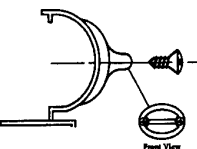

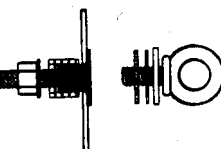
LP-268
KEY HOLE ESCUTCHEON
Chrome Plated Brass

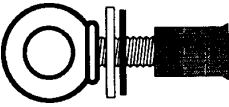
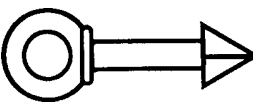
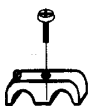
SLIDE FLANGE

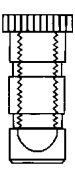

LP-270
SLIDE FLANGE
Fits 1.9" Rail
Includes Hardware
Hanover #: 24

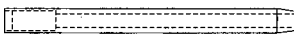
REPLACEMENT HOOKS	
	LP-273 1/2" CLEAT TYPE HOOK FOR SAFETY ROPE For 1/2" Rope
	LP-274 3/4" CLEAT TYPE HOOK FOR SAFETY ROPE For 3/4" Rope
	LP-275 1/2" LOOP TYPE HOOK Replaces Hayward #SP-45 Chrome Plated Brass
	LP-276 3/4" LOOP TYPE HOOK Replaces Hayward #SP-47 Chrome Plated Brass
	LP-277 S-HOOK Fits 1/4"-1/2" Rope Chrome Plated Brass
	LP-278 S-HOOK Fits 3/4" Rope Chrome Plated Brass
ROPE EYES AND GASKET	
 <small>Front View</small>	LP-290 FLAT OVAL ROPE EYE Chrome Plated Brass Includes Screws Sold by Pair
 <small>Front View</small>	LP-291 CURVED OVAL ROPE EYE FOR COPING MOUNT Chrome Plated Brass Includes Screws Sold by Pair
OVAL ROPE EYE GASKET	
	G-4461 GASKET FOR OVAL ROPE EYE
	LP-292 VINYL POOL ROPE EYE Designed for a positive seal with no wrinkling of the liner. Brass with Stainless Steel Fasteners

POOL / SAFETY COVER HARDWARE	
	LP-293 THREADED ROPE EYE WITH LEAD SLEEVE 7/8" Drill Wall Chrome Plated Brass
	LP-294 ARROW ROPE EYE For Concrete Pools Chrome Plated Brass
ROPE CLAMPS	
	LP-281 1/2" ROPE CLAMP Chrome Plated Brass
	LP-280 1/4" ROPE CLAMP Chrome Plated Brass
	LP-282 3/4" ROPE CLAMP Chrome Plated Brass
SAFETY COVER HARDWARE	
	SCH-430 7" STAINLESS STEEL COVER SPRING 302 Stainless Steel One side hooks onto brass anchor; other side connects to strap buckle.
	SCH-435 CONCRETE BRASS ANCHOR 3/4" Dia. x 1.63" L Has screw body. Fits into concrete.
	SCH-436 WOOD DECK ANCHOR Has screw body. Screws into wood deck.
	SCH-440 18" LONG ALUMINUM TUBE (HOLLOW ROD) Put this tube in less stable surfaces such as unmortared brick and stone. The brass anchor can then be tapped into this.
	SCH-441 18" ALUMINUM STAKE 1/2" Diameter For grass or dirt surfaces. Spring hooks directly onto this.

WINTERIZING PLUGS

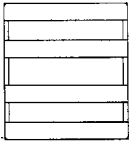

SCH-445
STAINLESS STEEL
BUCKLE
Connects strap on
cover to spring.



SCH-446
BRASS LAG COLLAR
Hides imperfections in the
concrete surrounding the
anchor made by drill.

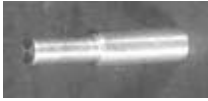

SCH-448
ALUMINUM TAMPING TOOL
Safely drives brass anchor
into concrete.

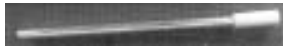

SCH-449
GALVANIZED STEEL
INSTALLATION ROD
(PRY ROD)
30" Long
Makes it easy to connect
spring to anchor.

BLOW THRU WINTERIZING PLUGS



These plugs allows the service
technician to release pressure
from the pipe or fitting without
removing the entire plug. Blow
Thru Winterizing Plugs are made
of a rubber plug, nylon wing nut
and cap, stainless steel washers
and a hollow brass blow thru
slotted screw.

SSC#	DIAMETER	FITS
WP-2BT	.75"	3/4" PIPE
WP-3BT	.89"	3/4" PIPE
WP-4BT	.96"	3/4" FITTING & 1" PIPE
WP-5BT	1.02"	1" TUBE
WP-6BT	1.20"	1" FITTING
WP-7BT	1.39"	1 1/4" PIPE
WP-8BT	1.54"	1 1/2" PIPE
WP-9BT	1.69"	1 1/4" FITTING & 1 1/2" PIPE
WP-10BT	1.89"	1 1/2" FITTING
WP-11BT	2.13"	2" PIPE
WP-12BT	2.42"	2" FITTING
WP-13BT	2.58"	2 1/2" PIPE

WINTERIZING EXPANSION PLUGS

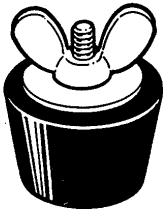

Our Winterizing Plugs are made of
a high quality rubber for maximum
expandability which ensures a tight
seal. These plugs are perfect for
pressure testing the system for
leaks as well normal winterizing
applications. They are made of a
stainless steel slotted screw,
washers, rubber plug and nylon
wing nuts for easy tightening.

SSC#	DIAMETER	FITS
WP-000	.46"	3/8" PIPE
WP-00	.54"	1/2" PIPE
WP-0	.63"	1/2" PIPE
WP-1	.70"	1.2" PIPE
WP-2	.75"	3/4" PIPE
WP-3	.89"	3/4" PIPE
WP-4	.96"	3/4" FITTING & 1" PIPE
WP-5	1.02"	1" TUBE
WP-6	1.20"	1" FITTING
WP-7	1.39"	1 1/4" PIPE
WP-8	1.54"	1 1/2" PIPE
WP-9	1.69"	1 1/4" FITTING & 1 1/2" PIPE
WP-10	1.89"	1 1/2" FITTING
WP-11	2.13"	2" PIPE
WP-12	2.42"	2" FITTING
WP-13	2.58"	2 1/2" PIPE
WP-14	3.40"	3" PIPE
WP-15	3.86"	4" PIPE
WP-16	4.64"	4" PIPE

EXTENDED WINTERIZING PLUGS



Extended Winterizing Plugs allow
you to locate the plug deeper into
the pipe or fitting thus ensuring a
positive seal. They are made of
a rubber plug, nylon wing nut,
stainless steel washers, slotted
screw and 1.625" extension.

SSC#	DIAMETER	FITS
WP-2X	.75"	3/4" PIPE
WP-3X	.89"	3/4" PIPE
WP-4X	.96"	3/4" FITTING & 1" PIPE
WP-5X	1.02"	1" TUBE
WP-6X	1.20"	1" FITTING
WP-7X	1.39"	1 1/4" PIPE
WP-8X	1.54"	1 1/2" PIPE
WP-9X	1.69"	1 1/4" FITTING & 1 1/2" PIPE
WP-10X	1.89"	1 1/2" FITTING
WP-11X	2.13"	2" PIPE
WP-12X	2.42"	2" FITTING
WP-13X	2.58"	2 1/2" PIPE

UNIVERSAL WINTERIZING PLUGS AND UNIVERSAL BLOW THRU PLUGS

These plugs are made of the same material described above
and fit the range of sizes listed below.

UNIVERSAL PLUGS

SSC#	FITS
WP-1-5UP	1 to 5
WP-5-7UP	5 to 7
WP-7-10UP	7 to 10



UNIVERSAL BLOW THRU

SSC#	FITS
WP-1-5UPBT	1 to 5
WP-5-7UPBT	5 to 7
WP-7-10UPBT	7 to 10



STEP GASK/AIR VALVES/SKIMMER SCREWS

MOLDED PLASTIC WINTERIZING PLUGS WITH O-RING

RAISED

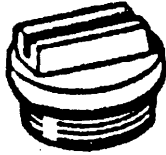

WP-20
 RAISED WINTERIZING PLUG WITH O-RING
 Made of Molded Plastic
 Replaces: Hayward SPX1022-C

FLUSH



WP-21
 FLUSH WINTERIZING PLUG WITH O-RING
 Made of Molded Plastic
 Replaces: Hayward SPX1022-B

AIR BLEEDER VALVES / DRAIN COCKS

Some common uses are to release air from Pool & Spa filters and water from pool heaters.

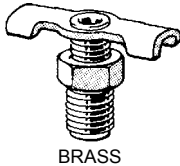

BRASS

SSC#	SIZE
122070	1/8"
122072	1/4"
122074	3/8"

STEP SECTION GASKET FOR VINYL LINER POOLS

These 1 1/2" wide x 16' long strips of neoprene rubber will seal the step section under the liner on inground pool installations. Packaged in coils for easy storage on service truck.



SG-200
 STEP SECTION GASKET
 1 1/2" Wide x 16' Long
 Packed in Coils

STAINLESS STEEL STAIR SCREWS



PACKED 100/BAG

SCR-425
 STAINLESS STEEL STAIR/STEP SCREWS
 Packed 100/Bag

STAINLESS STEEL TEK SCREWS (SELF-DRILLING)



PACKED 100/BAG

SCR-427
 STAINLESS STEEL TEK SCREWS
 Self Drilling
 Packed 100/Bag

SHEET METAL SCREWS



PACKED 100/BOX

- #8 thread
- Self piercing
- Hard steel--zinc plated
- Hex head type with screwdriver slot

SSC#	SIZE	PACKAGE TYPE
SH-635A	1/2"	100/BOX
SH-635B	3/4"	100/BOX
SH-635C	1"	100/BOX

REPLACEMENT STAINLESS STEEL SKIMMER SCREWS

REGULAR SIZE - 1"



SCR-410
 STAINLESS STEEL SKIMMER SCREWS
 Regular Size-1" Long
 Packed in a plastic bag with hanger hole and label for display
 Replaces: SPX1084-Z-4A and others
PACKAGE OF 12

SCR-412
 STAINLESS STEEL SKIMMER SCREWS
 Regular Size-1" Long
PACKAGE OF 100 (BULK PACK)

LONG SIZE - 1 1/4"



SCR-420
 STAINLESS STEEL SKIMMER SCREWS
 Long Size-1 1/4" Long
 Packed in a plastic bag with hanger hole and label for display
 Replaces: SPX1030-1C and others
PACKAGE OF 12

SCR-422
 STAINLESS STEEL SKIMMER SCREWS
 Long Size-1 1/4" Long
PACKAGE OF 100 (BULK PACK)

Please Note:

- Our 1" skimmer screw (#SCR-412) can also be used for **main drains**.
- Our 1 1/4" skimmer screw (#SCR-422) can also be used on **Hayward Lights**.

SKIMMER FACEPLATES / PLASTIC PARTS

AQUADOR SNAP-ON SKIMMER CLOSURE SYSTEM

The Aquador will save you time and money. When using Aquador you'll never have to lower the water level again when you close a pool for the winter or conduct repair work on a filter. The unique, easy to install design features a snap-on/snap-off lid which will remain flexible to 80° below zero temperatures.

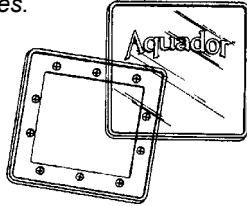

SSC#

SSC#	DESCRIPTION
AQ-390	FACEPLATE AND LID FOR 1090
AQ-390L	LID ONLY FOR 1090
AQ-391	FACEPLATE AND LID FOR A/G WIDEMOUTH
AQ-391L	LID ONLY FOR A/G WIDEMOUTH
AQ-392	FACEPLATE AND LID FOR DOUGHBOY
AQ-392L	LID ONLY FOR DOUGHBOY
AQ-393	FACEPLATE AND LID FOR LOMART
AQ-393L	LID ONLY FOR LOMART
AQ-394	FACEPLATE AND LID FOR 1084
AQ-394L	LID ONLY FOR 1084
AQ-395	FACEPLATE AND LID FOR I/G 1085
AQ-395L	LID ONLY FOR I/G 1085
AQ-397	FACEPLATE AND LID FOR AQUA GENIE I/G
AQ-397L	LID ONLY FOR AQUA GENIE I/G

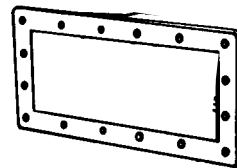

WHITE ABS PLASTIC

SF-452

SKIMMER FACEPLATE TO FIT HAYWARD 1085 WIDEMOUTH SKIMMERS
Use Gasket #G-3001
18 1/4" x 8 5/8"
Replaces: SPX1085-B

SKIMMER FACEPLATE COVERS



WHITE ABS PLASTIC

SF-451C

SKIMMER FACEPLATE COVER TO FIT HAYWARD 1084
8 3/4" x 11"
Replaces: SPX1084-F



WHITE ABS PLASTIC

SF-452C

SKIMMER FACEPLATE COVER TO FIT HAYWARD 1085 WIDEMOUTH
8 7/8" x 18 1/2"
Replaces: SPX1085-F

SQUARE SKIMMER COVER

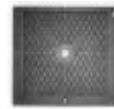

ABS PLASTIC

SC-491

SQUARE SKIMMER COVER
10 1/16" x 10 1/16"
Replaces: SPX1082-E

SKIMMER FACEPLATES TO FIT HAYWARD

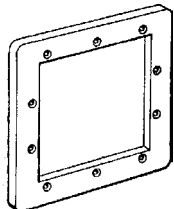

WHITE ABS PLASTIC

SF-450

SKIMMER FACEPLATE TO FIT HAYWARD 1090 SKIMMERS
Use Gasket # G-3006
8" x 8"
Replaces: SPX1090-D (K-2233)

VINYL POOL MAIN DRAIN SEALING FRAME RING



WHITE ABS PLASTIC

MF-457

VINYL POOL MAIN DRAIN SEALING FRAME RING
8" Diameter
Replaces: SPX1048-B

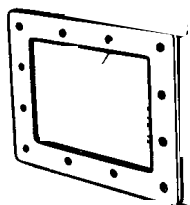

WHITE ABS PLASTIC

SF-451

SKIMMER FACEPLATE TO FIT HAYWARD 1084 SKIMMERS
Use Gasket #G-3020
10 1/2" x 8 1/4"
Replaces: SPX1084-L (K-2868)

SOCKET GUTTER REPLACEMENT GRATE



WHITE ABS PLASTIC

GC-490

SOCKET GUTTER REPLACEMENT GRATE
Includes Screws
Replaces: SPX1019-BA

RETURN FITTING FACEPLATE TO FIT HAYWARD

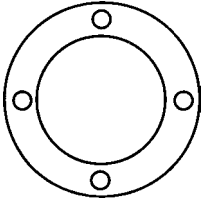

WHITE ABS PLASTIC

RF-455
 RETURN FITTING FACEPLATE TO FIT HAYWARD 1408 FITTING
 Use Gasket #G-4134
 3 1/2" x 2"
 Replaces: SPX1408-B (K-5187)

RETURN FITTINGS TO FIT HAYWARD

1408 FITTING FOR VINYL POOLS



WHITE ABS PLASTIC

RF-480
 VINYL POOL I/O FITTING TO FIT HAYWARD
 1 1/2" FIP x 1 1/2" FIP
 Replaces: SPX1408

1023 FITTING FOR VINYL POOLS



WHITE ABS PLASTIC

RF-481
 VINYL POOL I/O FITTING TO FIT HAYWARD
 1 1/2" FIP
 Replaces: SPX1023

1022 FITTING FOR GUNITE POOLS



WHITE ABS PLASTIC

RF-482
 GUNITE POOL I/O FITTING TO FIT HAYWARD
 1 1/2" Socket x 2" MIP
 Replaces: SPX1022

DIRECTIONAL FLOW OUTLET FITTINGS TO FIT HAYWARD

All of our directional flow fittings are made of white ABS plastic.



DF-485A
 SLOTTED SWEEP OPENING
 Replaces: SPX1419A



DF-485B
 3/8" DIRECTIONAL STREAM
 Replaces: SPX1419B



DF-485C
 1/2" DIRECTIONAL STREAM
 Replaces: SPX1419C



DF-485D
 3/4" DIRECTIONAL STREAM
 Replaces: SPX1419D

RETURN FACEPL./HOSE ADAPTER, CUFFS



DF-485E
 1" DIRECTIONAL STREAM
 Replaces: SPX1419E

HOSE ADAPTER

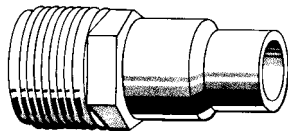

WHITE ABS PLASTIC

HA-460
 HOSE ADAPTER
 1 1/2" MIP x 1 1/4" & 1 1/2" HOSE
 Replaces: SP-1091-Z-7 (K-1759)

HOSE CUFFS

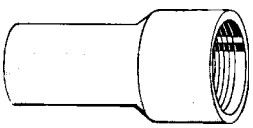

GRAY COLOR

HC-470
 1 1/4" HOSE CUFF
 Threaded
HC-471
 1 1/2" HOSE CUFF
 Threaded

HOSE COUPLERS

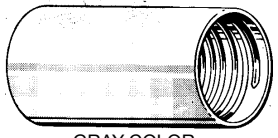

GRAY COLOR

HC-473
 1 1/4" HOSE COUPLER
 Threaded
HC-474
 1 1/2" HOSE COUPLER
 Threaded

9" LONG PLASTIC HOSE CONNECTOR

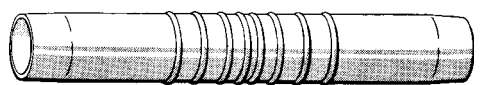

WHITE PLASTIC

HC-475
 9" LONG PLASTIC HOSE CONNECTOR
 Fits inside 1 1/4" cuff.

FLEXIBLE PIPE (TRANSITION) COUPLINGS

Our pipe couplings will fit over plastic and cast iron pipe. They feature all stainless steel clamps and thick-walled neoprene sleeves for strength, durability and an easy installation.

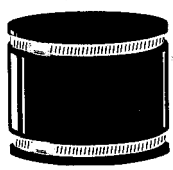

SSC#	PIPE SIZE
110254	1 1/2" x 1 1/2"
110258	2" x 2"
110264	3" x 3"
110270	4" x 3"
110272	4" x 4"

HOSE CLAMPS / RUBBER COUPLINGS

NO-HUB COUPLINGS

SSC's no-hub pipe couplings are used to join no hub cast iron soil pipe and fittings. A stainless steel corrugated shield and hose clamps are assembled over a molded neoprene sleeve to give you a strong, positive seal every time.

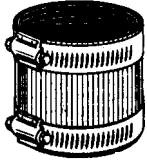

SSC#	PIPE SIZE
110300	1 1/2" x 1 1/2"
110302	2" x 1 1/2"
110304	2" x 2"
110306	3" x 3"
110310	4" x 4"

FLEXIBLE PIPE TEST (CLEAN-OUT) CAPS



NEOPRENE RUBBER
STAINLESS CLAMP

SSC#	PIPE SIZE
110380	1 1/2"
110382	2"
110384	3"
110386	4"

STAINLESS STEEL HOSE CLAMPS WITH PLATED STEEL SCREW

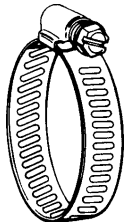

PACKED 10/BOX

- 304 series stainless steel band
- 430 series stainless steel housing
- Plated steel screw
- 1/2" wide band
- Packed 10 clamps in a box
- Competitively priced

SSC#	CLAMP#	SIZE
110506	6	3/8" to 7/8"
110508	8	7/16" to 1"
110510	10	9/16" to 1 1/16"
110512	12	11/16" to 1 1/4"
110516	16	13/16" to 1 1/2"
110520	20	13/16" to 1 3/4"
110524	24	11/16" to 2"
110528	28	1 5/16" to 2 1/4"
110532	32	1 9/16" to 2 1/2"
110536	36	1 13/16" to 2 3/4"
110540	40	2 1/16" to 3"
110544	44	2 5/16" to 3 1/4"
110548	48	2 9/16" to 3 1/2"
110552	52	2 13/16" to 3 3/4"
110556	56	3 1/16" to 4"
110560	60	3 5/16" to 4 1/4"
110564	64	3 9/16" to 4 1/2"
110572	72	4 1/8" to 5"

TORQUE WRENCH FOR HOSE CLAMPS

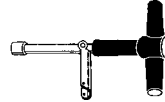

111062
TORQUE WRENCH
Tightens to 60 ft. lbs.

MINI HOSE CLAMPS

WITH PLATED STEEL SCREW



PACKED 10/BOX

- 304 series stainless steel band
- 430 series stainless steel housing
- Plated steel screw
- 5/16" wide band
- Packed 10 clamps in a box

SSC#	CLAMP#	SIZE
110501	4 Mini	7/32" to 5/8"
110502	6 Mini	7/16" to 25/32"

WITH STAINLESS STEEL SCREW



PACKED 10/BOX

- 304 stainless steel band & housing
- 302 stainless steel screw
- UPC approved
- 5/16" wide band
- Packed 10 clamps in a box

SSC#	CLAMP#	SIZE
110401	4 Mini	7/32" to 5/8"
110402	6 Mini	7/16" to 25/32"

STAINLESS STEEL HOSE CLAMPS WITH STAINLESS STEEL SCREW

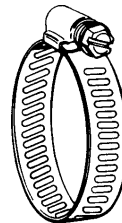

PACKED 10/BOX

- 304 series stainless steel band
- 304 series stainless steel housing
- 302 series stainless steel screw
- UPC approved
- Commonly known as "Marine Grade"
- 1/2" wide band
- Packed 10 clamps in a box
- Competitively priced

SSC#	CLAMP#	SIZE
110406	6	3/8" to 7/8"
110408	8	7/16" to 1"
110410	10	9/16" to 1 1/16"
110412	12	11/16" to 1 1/4"
110416	16	13/16" to 1 1/2"
110420	20	13/16" to 1 3/4"
110424	24	11/16" to 2"
110428	28	1 5/16" to 2 1/4"
110432	32	1 9/16" to 2 1/2"
110436	36	1 13/16" to 2 3/4"
110440	40	2 1/16" to 3"
110444	44	2 5/16" to 3 1/4"
110448	48	2 9/16" to 3 1/2"
110452	52	2 13/16" to 3 3/4"
110456	56	3 1/16" to 4"
110460	60	3 5/16" to 4 1/4"
110464	64	3 9/16" to 4 1/2"
110472	72	4 1/8" to 5"

PVC BALL VALVES, UNIONS, FITTINGS

TEST PLUGS (DOLLAR PLUGS)



GALVANIZED STEEL FLANGE
MOLDED RUBBER GASKET

SSC#	PIPE SIZE
110202	1 1/2"
110204	2"
110206	3"
110208	4"

HINGED PIPE REPAIR CLAMPS

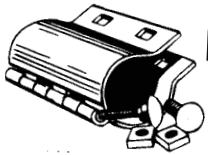

SSC#	PIPE SIZE
110350	1/2"
110352	3/4"
110354	1"
110356	1 1/4"
110358	1 1/2"
110360	2"

PVC SCHEDULE 40 FITTINGS



SLIP COUPLING SLIP X MALE SLIP X FEMALE SLIP 90° ELBOW



SLIP X MALE 90° SLIP X FEMALE 90° SLIP X SPIGOT 90°

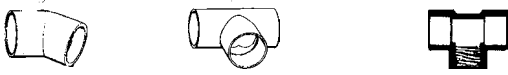

SLIP 45° ELBOW SLIP TEE SLIP X SLIP X FEMALE TEE



SLIP CAP SLIP X SLIP X FEMALE REDUCING TEE

DESCRIPTION	1 1/2" (SSC#)	2" (SSC#)
Slip Coupling	133110	134220
Slip X Male Adapter	133120	134230
Slip X Female Adapter	133130	134240
Slip 90° Elbow	133140	134250
Slip X Male 90° Elbow	133150	134260
Slip X Female 90° Elbow	133160	134270
Slip X Spigot 90° Elbow	133170	134280
Slip 45° Elbow	133180	134290
Slip Tee	133190	134300
Slip X Slip X Female Tee	133200	134310
Slip Cap	133210	134320

1 1/2" Slip X 1 1/2" Slip X 3/4" Female Reducing Tee: #135100

PVC SCHEDULE 40 UNIONS

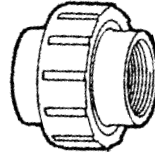

IPS

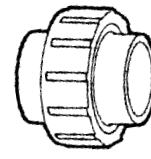

SOLVENT

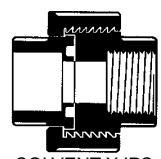

SOLVENT X IPS

SSC#

120230
120232
120250
120252
120260
120262

SIZE

1 1/2" IPS (FIP)
2" IPS (FIP)
1 1/2" SOLVENT
2" SOLVENT
1 1/2" SOLVENT X IPS (FIP)
2" SOLVENT X IPS (FIP)

SINGLE UNION PVC BALL VALVES

SSC's Single Union Ball Valves are lightweight and compact and designed for Pool & Spa installations. The full port ball gives minimum pressure drop and the valves are rated at 225 psi test pressure and 150 psi working pressure.

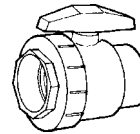

SOCKET / IPS (FIP) END



NIPPLE END

SSC#

120270
120272
120280
120282
120290

SIZE

1 1/2" SOLVENT END
2" SOLVENT END
1 1/2" IPS (FIP)
2" IPS (FIP)
1 1/2" NIPPLE END (MIP)

PVC BALL VALVES

IPS

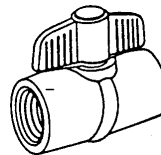

1 PIECE CONSTRUCTION
1/4 TURN OPERATION

SSC#

122324
122326
122328
122330
122332
122334

SIZE

1/2"
3/4"
1"
1 1/4"
1 1/2"
2"

SOLVENT WELD

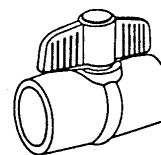

1 PIECE CONSTRUCTION
1/4 TURN OPERATION

SSC#

122354
122356
122358
122360
122362
122364

SIZE

1/2"
3/4"
1"
1 1/4"
1 1/2"
2"

CHECK VALVES/COMPRESSION COUPLINGS

FULL PORT FORGED BRASS BALL VALVES - 600 WOG

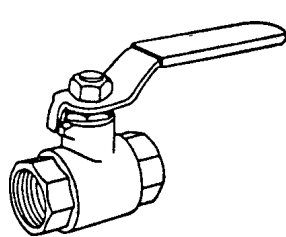

IPS

- Full Port
- 600 WOG / 150 WSP
- Forged Brass
- Yellow Vinyl Covered Handle

SSC#	SIZE
122132	3/8"
122134	1/2"
122136	3/4"
122138	1"
122140	1 1/4"
122142	1 1/2"
122144	2"

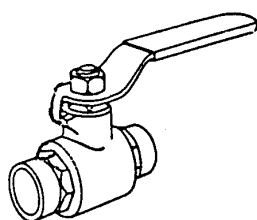

C x C

- Full Port
- 600 WOG / 150 WSP
- Forged Brass
- Yellow Vinyl Covered Handle

SSC#	SIZE
122104	1/2"
122106	3/4"
122108	1"
122110	1 1/4"
122112	1 1/2"
122114	2"

BRASS SWING CHECK VALVES

Our brass swing check valves have a hinged flap and can be used in water or oil applications.



IPS

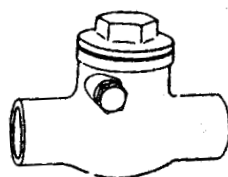

C x C

SSC#	SIZE
121004	1/2" CxC
121006	3/4" CxC
121008	1" CxC
121010	1 1/4" CxC
121012	1 1/2" CxC
121014	2" CxC
121032	1/2" IPS
121034	3/4" IPS
121036	1" IPS
121038	1 1/4" IPS
121040	1 1/2" IPS
121042	2" IPS

PVC CHECK VALVES - SPRING LOADED

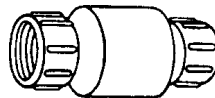

IPS

SSC#
121132
121150
121152

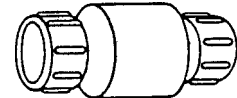

SOLVENT WELD

SIZE
1 1/2" IPS
1 1/2" SOLVENT
2" SOLVENT

SEWAGE EJECTOR CHECK VALVE

COMBINATION SIZE - FITS 1 1/4" & 1 1/2" IPS



121170

SEWAGE EJECTOR CHECK VALVE
Plastic Valve Body with Rubber Ends & Hose Clamps
Combination Size: 1 1/4" & 1 1/2" IPS

PVC COMPRESSION COUPLINGS - LONG PATTERN

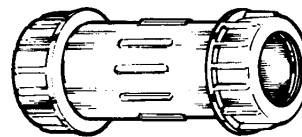

SSC#	DESCRIPTION	PIPE SIZE
121222	LONG PATTERN	1/2"
121224	LONG PATTERN	3/4"
121226	LONG PATTERN	1"
121228	LONG PATTERN	1 1/4"
121230	LONG PATTERN	1 1/2"
121232	LONG PATTERN	2"

GALVANIZED COMPRESSION COUPLINGS - LONG PATTERN

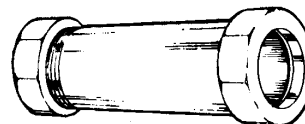

SSC#	DESCRIPTION	PIPE SIZE
121253	LONG PATTERN	1/2"
121255	LONG PATTERN	3/4"
121257	LONG PATTERN	1"
121259	LONG PATTERN	1 1/4"
121261	LONG PATTERN	1 1/2"
121263	LONG PATTERN	2"

BOILER DRAINS / SILLCOCKS

BOILER DRAINS

MALE IRON PIPE

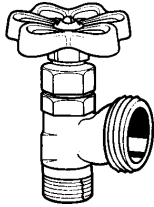

122408
BOILER DRAIN WITH STUFFING BOX
3/4" Hose End
Brass
1/2" MIP

122410
BOILER DRAIN WITH STUFFING BOX
3/4" Hose End
Brass
3/4" MIP

FEMALE IRON PIPE

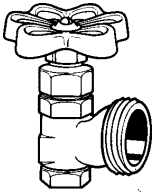

122404
BOILER DRAIN WITH STUFFING BOX
3/4" Hose End
Brass
1/2" FIP

STOP AND WASTE VALVES

C x C

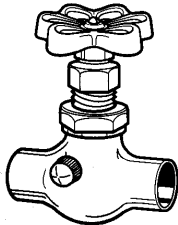

122606
STOP AND WASTE VALVE
With Bleeder Cap
Brass
1/2"

122608
STOP AND WASTE VALVE
With Bleeder Cap
Brass
3/4"

STOP AND WASTE CAP



122620
STOP AND WASTE CAP
5/16" x 24T
Includes Washer
Brass

HOSE BIBBS

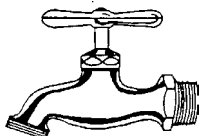

CHROME PLATED BRASS

SSC#	TYPE	SIZE
160010	3/4" HOSE END	1/2" MIP
160020	3/4" HOSE END	3/4" MIP
160030	PLAIN END	1/2" MIP
160035	PLAIN END	3/4" MIP

ANGLE SILLCOCKS

FEMALE IRON PIPE

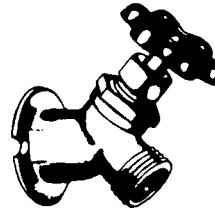

122544
ANGLE SILLCOCK
3/4" Hose Outlet
Brass
1/2" FIP

122546
ANGLE SILLCOCK
3/4" Hose Outlet
Brass
3/4" FIP

C x C

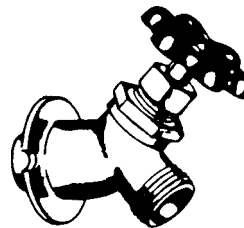

122540
ANGLE SILLCOCK
3/4" Hose Outlet
Brass
1/2" C x C

122542
ANGLE SILLCOCK
3/4" Hose Outlet
Brass
3/4" C x C

FROST FREE SILLCOCKS

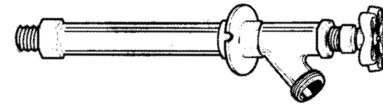

CHROME PLATED BRASS

SSC#	DESCRIPTION	LENGTH
122505	1/2" MIP x 1/2" CxC	6"
122507	1/2" MIP x 1/2" CxC	8"
122509	1/2" MIP x 1/2" CxC	10"
122511	1/2" MIP x 1/2" CxC	12"

ANTI-SYPHON FROST FREE SILLCOCKS

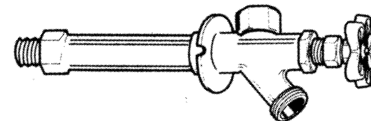

CHROME PLATED BRASS

SSC#	DESCRIPTION	LENGTH
122525	1/2" MIP x 1/2" CxC	6"
122527	1/2" MIP x 1/2" CxC	8"
122529	1/2" MIP x 1/2" CxC	10"
122531	1/2" MIP x 1/2" CxC	12"

4-WAY SILLCOCK KEY

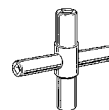

111020
4-WAY SILLCOCK KEY
Fits 1/4", 9/32", 5/16", 11/32"

HOSE PARTS

HOSE CAPS AND GASKETS

BRASS HOSE CAP WITH GASKET INCLUDED

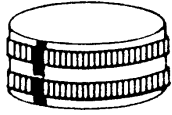

INCLUDES GASKET

HC-305

BRASS HOSE CAP FOR 3/4" THREAD
For capping boiler drains, valves, hoses etc.
Made of knurled brass
Includes G-194 gasket

PLASTIC HOSE CAP WITH GASKET INCLUDED

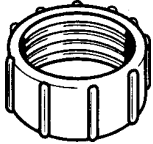

INCLUDES GASKET

HC-306

PLASTIC HOSE CAP FOR 3/4" THREAD
Same as above except made of plastic
Includes G-194 gasket

HOSE CAP WASHERS



ACTUAL SIZE: 1 1/16" OD
X 9/16" ID

G-194

HOSE CAP WASHER
Neoprene (Black Rubber)

G-194RR

HOSE CAP WASHER
Red Rubber

MISCELLANEOUS HOSE PARTS

HOSE INLET FILTER SCREEN



122569

Prevents Sediment
3/4"

SIAMESE HOSE CONNECTION

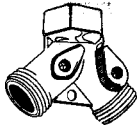

122568

With Dual Shut-Off
3/4"

REPAIR COUPLING - MALE END



122565

Plastic
3/4"

REPAIR COUPLING - FEMALE END



122566

Plastic
3/4"

HOSE MENDER



122567

Connects 2 Hose Pieces
Plastic
3/4"

HOSE BACKFLOW PREVENTER

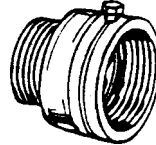

122570

HOSE BACKFLOW PREVENTER (Vacuum Breaker)
Rough Brass
3/4" Female Hose X 3/4" M
With Break-off Set Screw

BRASS HOSE FITTINGS

FEMALE HOSE TO FEMALE PIPE



122573

3/4" FH X 3/4" FIP

MALE HOSE TO FEMALE PIPE



122576

3/4" MH X 3/4" FIP

MALE HOSE TO MALE HOSE



122579

3/4" MH X 3/4" MH

FEMALE HOSE TO MALE PIPE



122581

3/4" FH X 3/4" MIP
(1/2" FIP TAPPED)

MALE HOSE TO MALE PIPE

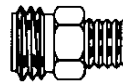

122584

3/4" MH X 3/4" MIP
(1/2" FIP TAPPED)

FEMALE HOSE TO FEMALE HOSE SWIVEL



122587

3/4" FH X 3/4" FH

FEMALE HOSE TO FEMALE PIPE SWIVEL



122590

3/4" FH X 3/4" 3/4" FIP

PACKING / PIPE FLANGE GASKETS

AIR BLEEDER VALVES / DRAIN COCKS

Some common uses are to release air from Pool & Spa filters and water from pool heaters.

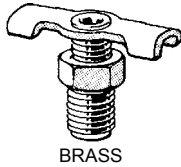

BRASS

SSC#	SIZE
122070	1/8"
122072	1/4"
122074	3/8"

SELF-TAPPING SADDLE VALVE



INDIVIDUALLY BAGGED

122600
SELF-PIERCING
SADDLE VALVE
 Connects 1/4" bleed
 lines to copper tubing
 from 3/8" to 1 3/8"

MECHANICAL PACKING - GRAPHITE, TEFLON AND NON-STAINING GRAPHITE

SSC's packing can be used to seal shafts, valve plugs and other general service applications.



PACKED IN 1 LB. SPOOLS & INDIVIDUALLY BOXED

SSC#	TYPE	SIZE	FT/LB	TEMP.
PAC-29A	N/S GRAPHITE	1/8"	101	550°
PAC-29B	N/S GRAPHITE	3/16"	60	550°
PAC-29C	N/S GRAPHITE	1/4"	25	550°
PAC-29D	N/S GRAPHITE	5/16"	14.1	550°
PAC-29E	N/S GRAPHITE	3/8"	10	550°
PAC-29F	N/S GRAPHITE	1/2"	5.7	550°
PAC-30A	GRAPHITE	1/8"	101	550°
PAC-30B	GRAPHITE	3/16"	60	550°
PAC-30C	GRAPHITE	1/4"	25	550°
PAC-30D	GRAPHITE	5/16"	14.1	550°
PAC-30E	GRAPHITE	3/8"	10	550°
PAC-30F	GRAPHITE	1/2"	5.7	550°
PAC-31A	TEFLON	1/8"	75.5	500°
PAC-31B	TEFLON	3/16"	34.3	500°
PAC-31C	TEFLON	1/4"	20.9	500°
PAC-31D	TEFLON	5/16"	13.4	500°
PAC-31E	TEFLON	3/8"	8.7	500°
PAC-31F	TEFLON	1/2"	6	500°

PIPE FLANGE GASKETS

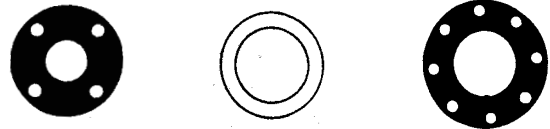

For 150 lb. flanges and fittings. Old standard or new ANSI. Inside measurements are used.

MATERIAL: 1/8" THICK RED RUBBER

SIZE	RING GASKET	FULL FACE GASKET
1/2	PF-50RR8	PF-50RF8
3/4	PF-75RR8	PF-75RF8
1	PF-100RR8	PF-100RF8
1 1/4	PF-125RR8	PF-125RF8
1 1/2	PF-150RR8	PF-150RF8
2	PF-200RR8	PF-200RF8
2 1/2	PF-250RR8	PF-250RF8
3	PF-300RR8	PF-300RF8
3 1/2	PF-350RR8	PF-350RF8
4	PF-400RR8	PF-400RF8
4 1/2	PF-450RR8	PF-450RF8
5	PF-500RR8	PF-500RF8
6	PF-600RR8	PF-600RF8
7	PF-700RR8	PF-700RF8
8	PF-800RR8	PF-800RF8
10	PF-1000RR8	PF-1000RF8
12	PF-1200RR8	PF-1200RF8

MATERIAL: 1/16" THICK RED RUBBER

SIZE	RING GASKET	FULL FACE GASKET
1/2	PF-50RR16	PF-50RF16
3/4	PF-75RR16	PF-75RF16
1	PF-100RR16	PF-100RF16
1 1/4	PF-125RR16	PF-125RF16
1 1/2	PF-150RR16	PF-150RF16
2	PF-200RR16	PF-200RF16
2 1/2	PF-250RR16	PF-250RF16
3	PF-300RR16	PF-300RF16
3 1/2	PF-350RR15	PF-350RF16
4	PF-400RR16	PF-400RF16
4 1/2	PF-450RR16	PF-450RF16
5	PF-500RR16	PF-500RF16
6	PF-600RR16	PF-600RF16
7	PF-700RR16	PF-700RF16
8	PF-800RR16	PF-800RF16
10	PF-1000RR16	PF-1000RF16
12	PF-1200RR16	PF-1200RF16

PIPE FLANGE GASKETS

MATERIAL: 1/8" THICK NEOPRENE (BLACK) RUBBER

SIZE	RING GASKET	FULL FACE GASKET
1/2	PF-50NR8	PF-50NF8
3/4	PF-75NR8	PF-75NF8
1	PF-100NR8	PF-100NF8
1 1/4	PF-125NR8	PF-125NF8
1 1/2	PF-150NR8	PF-150NF8
2	PF-200NR8	PF-200NF8
2 1/2	PF-250NR8	PF-250NF8
3	PF-300NR8	PF-300NF8
3 1/2	PF-350NR8	PF-350NF8
4	PF-400NR8	PF-400NF8
4 1/2	PF-450NR8	PF-450NF8
5	PF-500NR8	PF-500NF8
6	PF-600NR8	PF-600NF8
7	PF-700NR8	PF-700NF8
8	PF-800NR8	PF-800NF8
10	PF-1000NR8	PF-1000NF8
12	PF-1200NR8	PF-1200NF8

MATERIAL: 1/16" THICK NEOPRENE (BLACK) RUBBER

SIZE	RING GASKET	FULL FACE GASKET
1/2	PF-50NR16	PF-50NF16
3/4	PF-75NR16	PF-75NF16
1	PF-100NR16	PF-100NF16
1 1/4	PF-125NR16	PF-125NF16
1 1/2	PF-150NR16	PF-150NF16
2	PF-200NR16	PF-200NF16
2 1/2	PF-250NR16	PF-250NF16
3	PF-300NR16	PF-300NF16
3 1/2	PF-350NR16	PF-350NF16
4	PF-400NR16	PF-400NF16
4 1/2	PF-450NR16	PF-450NF16
5	PF-500NR16	PF-500NF16
6	PF-600NR16	PF-600NF16
7	PF-700NR16	PF-700NF16
8	PF-800NR16	PF-800NF16
10	PF-1000NR16	PF-1000NF16
12	PF-1200NR16	PF-1200NF16

MATERIAL: 1/16" THICK NON-ASBESTOS

SIZE	RING GASKET	FULL FACE GASKET
1/2	PF-50AR16	PF-50AF16
3/4	PF-75AR16	PF-75AF16
1	PF-100AR16	PF-100AF16
1 1/4	PF-125AR16	PF-125AF16
1 1/2	PF-150AR16	PF-150AF16
2	PF-200AR16	PF-200AF16
2 1/2	PF-250AR16	PF-250AF16
3	PF-300AR16	PF-300AF16
3 1/2	PF-350AR16	PF-350AF16
4	PF-400AR16	PF-400AF16
4 1/2	PF-450AR16	PF-450AF16
5	PF-500AR16	PF-500AF16
6	PF-600AR16	PF-600AF16
7	PF-700AR16	PF-700AF16
8	PF-800AR16	PF-800AF16
10	PF-1000AR16	PF-1000AF16
12	PF-1200AR16	PF-1200AF16

MATERIAL: 1/8" THICK NON-ASBESTOS

SIZE	RING GASKET
1/2	PF-50AR8
3/4	PF-75AR8
1	PF-100AR8
1 1/4	PF-125AR8
1 1/2	PF-150AR8
2	PF-200AR8
2 1/2	PF-250AR8
3	PF-300AR8

BOLT PACKS



SSC's Bolt Packs include any of the above listed Pipe Flange Gaskets individually packed with the appropriate ASTM-A307 Grade 2 hex head bolts with finished hex nuts. These kits offer the convenience of having all flange parts in one package. To order a kit just add the letters "BP" to the end of the gasket number listed above. For example to order a 4" full faced flange gasket (1/8" Red Rubber) bolt pack, use part #PF-400RF9BP.

PIPE FLANGE BOLTS AND NUTS

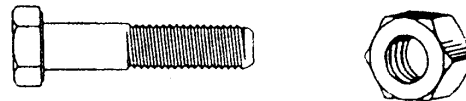

SSC#	DESCRIPTION
PF-100B	BOLT FOR 1/2", 3/4", 1", 1 1/4", 1 1/2" PIPE FLGS.
PF-100N	NUT FOR 1/2", 3/4", 1", 1 1/4", 1 1/2" PIPE FLGS.
PF-200B	BOLT FOR 2", 2 1/2", 3", 3 1/2", 4", 4 1/2" PIPE FLG
PF-200N	NUT FOR 2", 2 1/2", 3", 3 1/2", 4", 4 1/2" PIPE FLGS.
PF-500B	BOLT FOR 5", 6", 7", 8" PIPE FLANGES
PF-500N	NUT FOR 5", 6", 7", 8" PIPE FLANGES
PF-1000B	BOLT FOR 10", 12" PIPE FLANGES
PF-1000N	NUT FOR 10", 12" PIPE FLANGES

CROSS REFERENCE-ALADDIN TO SSC

ALD.#	SSC#	ALD.#	SSC#	ALD.#	SSC#	ALD.#	SSC#	ALD.#	SSC#	ALD.#	SSC#	ALD.#	SSC#	ALD.#	SSC#
GASKETS															
G-001	G-3177	G-092	G-4269	G-194	G-3247	G-292	G-4420	O-RINGS		O-155	O-2090	O-254	K-6004	O-354V	O-2610
G-002	G-3116	G-093	G-4214	G-195	G-4131	G-293	G-3252	O-002	O-1225	O-155V	O-2508	O-255	O-2155	O-355V	O-2516
G-003	G-3151	G-094	G-4270	G-196	G-4305	G-294	G-3234	O-004	O-2100	O-158	O-2220	O-256	O-2170	O-356V	O-2515
G-004	G-3216	G-095	O-1209	G-197	G-4353	G-295	G-4428	O-005	O-2102	O-159	O-2189	O-257	O-2262	O-357V	O-2607
G-005	G-3114	G-097	G-4409	G-198	G-4403	G-296	G-3110	O-006	G-4217	O-160	O-2217	O-258	O-2201	O-358	O-2110
G-006	G-3117	G-098	G-4324	G-199	G-4404	G-297	G-3112	O-010	G-4254	O-161	O-2604	O-259	O-1019	O-359	O-2103
G-007	G-3257	G-099P	G-3241	G-200	G-4334	G-298	G-3258	O-012	O-2247	O-163	O-2214	O-261	G-4277	O-360	O-2131
G-008	G-3162	G-099R	G-4441	G-201	G-3133	G-299	G-4209	O-013	O-2167	O-165	O-2223	O-262	G-5040	O-361	O-2005
G-009	G-3107	G-099RS	G-4411	G-202	G-4309	G-300	G-4335	O-014	O-2240	O-168	O-2155	O-263	O-2058	O-362	O-2051
G-010	G-3130	G-100	G-3121	G-203	G-3136	G-301	G-5022	O-015	O-2099	O-169	O-2404	O-264	G-5016	O-363	O-2259
G-011	G-3207	G-101	G-3109	G-204	G-3118	G-303	G-4314	O-016	G-4444	O-170	O-1212	O-265	G-5052	O-364	O-2003
G-012	G-3211	G-102R	G-4122	G-206	G-3271	G-305	G-5036	O-018	O-2109	O-171	O-2086	O-266	G-5014	O-365	O-2001
G-013	G-3236	G-103	G-4264	G-207	G-4323	G-307	G-5012	O-019	O-2218	O-171	O-2605	O-267	G-5010	O-366	O-1054
G-014	G-3104	G-104	G-4273	G-208	G-3235	G-308	G-5057	O-020	O-2138	O-172	G-5126	O-268	O-1030	O-367	O-2211
G-015	G-3126	G-105	G-4332	G-209	G-3150	G-309	G-4432	O-021	G-4248	O-173	G-5124	O-269	O-2140	O-368	O-2017
G-016	G-3152	G-106	G-4121	G-210	G-3122	G-310	G-4256	O-022	G-4233	O-176	G-5108	O-270	G-5017	O-370	O-2010
G-017	G-4128	G-107	G-4261	G-211	G-3203	G-311	G-4223	O-023	G-4287	O-176A	G-5106	O-271	K-6006	O-371	G-5055
G-018	G-3240	G-108	G-4306	G-212	G-3250	G-312	G-4246	O-024	O-2106	O-177	O-1226	O-273	O-2200	O-372	O-1028
G-018R	G-4033	G-109	G-4438	G-213	G-4226	G-313	G-4031	O-025	O-2141	O-178	K-6002	O-275	O-2117	O-373	O-1130
G-019	G-3248	G-110	G-3158	G-214	G-4281	G-314	G-4015	O-026	O-2008	O-179	O-2282	O-276	O-2256	O-374	O-1040
G-020	G-3139	G-111	G-4436	G-216	G-3233	G-315	G-4012	O-027	O-2133	O-180	O-2150	O-277	O-2067	O-375	O-1080
G-021	G-3147	G-112P	G-3170	G-216	G-4206	G-316	G-5046	O-027V	O-2611	O-182	O-2028	O-278	O-2139	O-376	O-1127
G-022	G-4003	G-112R	G-4116	G-217	G-4267	G-317	O-1210	O-030	O-2135	O-183	O-2032	O-27A	G-5142	O-377	O-1033
G-023	G-4004	G-113	G-3020	G-219	G-4244	G-318	G-4295	O-030V	O-2502	O-184	O-1062	O-280	O-1126	O-378	O-1050
G-024	G-4027	G-114	G-5034	G-220	G-3148	G-319	G-4405	O-032	O-2254	O-185	O-1056	O-281	O-2125	O-379	O-1038
G-025	G-3246	G-115P	G-3006	G-221	G-3220	G-320	G-4114	O-032V	O-2505	O-186	O-2208	O-282	O-2203	O-380	O-1077
G-027	G-3102	G-115R	G-4001	G-222	G-4406	G-321	G-3143	O-033	O-2405	O-186V	O-2521	O-283	O-2114	O-381	O-1131
G-028	G-4210	G-116	G-4419	G-223	G-4412	G-322	G-4439	O-034	O-2411	O-188	O-2144	O-283V	O-2522	O-382	O-1060
G-029	G-4315	G-117	G-4251	G-224	G-4422	G-323	G-4294	O-037	O-2009	O-188V	O-2510	O-284	O-2091	O-384	O-2164
G-030	G-4326	G-118	G-4208	G-225	G-3242	G-324	G-3144	O-039	O-2024	O-189	O-2263	O-285	O-2177	O-385	O-1095
G-031	G-4011	G-119	G-4275	G-226	G-4134	G-325	G-3209	O-039V	O-2519	O-190	G-5117	O-286	O-2066	O-389	O-2410
G-032	G-3204	G-120	G-3206	G-227	G-4265	G-326	G-3180	O-040	O-2231	O-191	O-1063	O-287	O-2189	O-390	O-2221
G-033	G-4414	G-121	G-4019	G-228	G-3146	G-327	G-3269	O-041	O-2040	O-194	G-5024	O-288	O-2239	O-391	O-2223
G-034	G-4327	G-122	G-4434	G-229	G-4215	G-328	G-3149	O-043	O-2270	O-195	O-1227	O-288V	O-2514	O-392	G-5104
G-035	G-4240	G-123	G-4410	G-230	G-3268	G-329	G-4014	O-045	O-2406	O-197	O-1122	O-289	O-1132	O-392A	G-5105
G-036	G-3023	G-124	G-4252	G-231	G-4300	G-330	G-3008	O-047	O-2124	O-198	O-1020	O-292	O-1070	O-394	O-1004
G-037	G-5048	G-125	G-3138	G-232	G-3280	G-331	G-4026	O-048	O-2128	O-199	O-1026	O-294	O-1052	O-395	O-2409
G-040	G-3259	G-126	G-3154	G-233	G-3009	G-332	G-3230	O-049	O-2195	O-200	O-1037	O-295	O-1064	O-396	O-2137
G-041	G-4242	G-127C	G-3202	G-234	G-3011	G-333	G-3225	O-050	O-2006	O-201	O-1121	O-296	O-1051	O-397	O-2087
G-042	G-5043	G-127R	G-4186	G-235	G-4417	G-335	G-3004	O-064	O-2165	O-202	O-1090	O-297	O-1066	O-398	O-2261
G-043	G-3108	G-130	G-4230	G-236	G-4232	G-336	G-4228	O-066	G-4238	O-203	O-1045	O-298	O-1058	O-399	O-2414
G-044	G-3256	G-132	G-3217	G-237	G-4225	G-337	G-4237	O-067	G-5129	O-204	O-1025	O-299	O-2209	O-400	O-2079
G-044A	G-3249	G-133	G-4203	G-238	G-4312	G-338	G-3132	O-068	G-4322	O-205	O-1031	O-300	G-5045	O-401	O-2012
G-045	G-3266	G-134	G-4427	G-239	G-5050	G-339	G-4250	O-069	O-2264	O-206	G-5114	O-301	O-2226	O-402	O-2266
G-046	G-3166	G-135	G-3153	G-240	G-5051	G-340	G-4202	O-070	G-4418	O-207	O-2188	O-302	O-2080	O-403	O-2004
G-047	G-3219	G-136	G-3176	G-241	G-3022	G-341	G-4263	O-071	O-2068	O-209	G-4253	O-303	O-2104	O-404	G-5053
G-048	G-3224	G-137	G-3172	G-242	G-3145	G-342	G-4408	O-072	O-2119	O-210	G-5111	O-304	O-2216	O-405	O-1120
G-049	G-3111	G-138	G-4125	G-243	G-4286	G-343	G-4266	O-073	G-4285	O-211	G-5112	O-305	O-1215	O-407	G-5131
G-050	G-3103	G-139	G-4433	G-244	G-4304	G-344	G-4201	O-074	O-2121	O-212	O-1018	O-306	O-1041	O-408	O-2122
G-051	G-3105	G-140	G-3021	G-245	G-4224	G-345	O-1217	O-076	G-5039	O-213	O-2038	O-307	O-2212	O-409	O-2215
G-052	G-3229	G-141	G-3171	G-246	G-4255	G-346	G-4220	O-079	G-5003	O-214	O-1016	O-308	O-1034	O-410	O-2127
G-053	G-3140	G-142	G-4102	G-247	G-4442	G-347	G-4424	O-080	O-2228	O-215	G-5006	O-309	O-1052	O-411	O-2304
G-054	G-3226	G-143	G-4258	G-248	G-4282	G-349	G-4407	O-081	O-2417	O-216	O-2029	O-312	O-1023	O-412	O-1012
G-055	G-3178	G-144	G-5041	G-249	G-4303	G-354	G-4234	O-082	O-2402	O-217	O-1035	O-313	O-2101	O-413	O-2181
G-056	G-3127	G-145	G-5023	G-250	G-4310	G-355	G-4222	O-083	O-2002	O-218	O-2060	O-314	O-1069	O-414	O-1129
G-057	G-3275	G-146	O-1125	G-251	G-4310	G-356	G-4111	O-085	O-1074	O-219	O-2257	O-315	O-2092	O-415	O-1065
G-058	G-3120	G-147	G-5027	G-252	G-4211	G-357	G-3017	O-086	O-1073	O-220	O-2205	O-316	O-1022	O-416V	K-6003
G-059	G-4431	G-150	G-3124	G-253	G-4316	G-358	G-4007	O-087	O-1039	O-222	O-2020	O-317	O-1027	O-417	G-5028
G-060	G-4005	G-151	G-3131	G-254	G-4297	G-359	G-5008	O-088	O-1067	O-223	O-2049	O-318	O-2172	O-418	K-6001
G-061	G-4017	G-152	G-3173	G-255	G-4311	G-361	G-4018	O-089	O-1032	O-224	O-2234	O-319	O-2030	O-419	G-5061
G-062	G-4008	G-153	G-3137	G-256	G-4025	G-363	G-3277	O-090	O-1014	O-225	O-2255	O-320	O-2044	O-419	O-2046
G-063	G-4115	G-154	G-3016	G-258	G-4310	G-364	G-4216	O-092	O-1008	O-225V	O-2614	O-321	O-2243	O-421	O-2015
G-064P	G-3125	G-155	G-3003	G-259	G-4333	G-365	G-3129	O-093	O-1042	O-226	O-2020	O-323	O-1036	O-422	O-2219
G-064R	G-4119	G-156	G-3018	G-260	G-3274	G-366	G-3208	O-096	O-1014	O-227	O-2020	O-324	O-2224	O-423	O-1124
G-065	G-3168	G-157	G-3001	G-261	G-3025	G-367	G-4426	O-099	O-1048	O-228	O-2252	O-325	O-2106	O-424	O-2105
G-066	G-4336	G-158	G-3019	G-262	G-3245	G-368	G-3123	O-100	O-1133	O-229	O-2146	O-326	O-2129	O-426	O-1017
G-068	G-3128	G-159	G-4110	G-263	G-4262	G-369	G-3014	O-101	O-1015	O-230	O-2272	O-327	O-2116	O-427	O-1123
G-069	G-3228	G-160	G-4280	G-264	G-3134	G-370	G-4284	O-102	O-1043	O-231	O-2007	O-328	O-2089	O-428	O-2408
G-070	G-3255	G-161	G-4328	G-265	G-3101	G-371	G-4221	O-103	O-1159	O-231V	O-2511	O-329	O-2026	O-429	O-1001

CROSS REFERENCE-HYDROVALVE TO SSC

ALD.#	SSC#	ALD.#	SSC#	HYD.#	SSC#	HYD.#	SSC#	HYD.#	SSC#	HYD.#	SSC#	HYD.#	SSC#	HYD.#	SSC#		
O-455	O-2153	GOKIT34	R-6141	HYDROVALVE				K-1609	O-1042	K-2754	O-2167	K-3642	E-6502	K-5777	O-1001	K-5886	O-2010
O-456	O-2242	GOKIT35	R-6142	K-1155	G-3144	K-1627	E-6506	K-1627	K-2755	O-2209	K-3644	G-3256	K-5778	G-4212	K-5887	O-2280	
O-457	O-2295	GOKIT36	R-6140	K-1169	G-3214	K-1647	O-2025	K-1647	O-2262	K-3645	O-1010	K-5779	G-2106	K-5888	O-2141		
O-458	O-2373	GOKIT38	R-6133	K-1170	G-3218	K-1648	O-2041	K-1648	K-2760	G-3256	K-3646	O-1074	K-5780	O-2105	K-5889	O-2041	
O-459	O-2059	GOKIT40	R-6146	K-1203	G-3209	K-1654	DF-485C	K-1654	K-2761	O-1016	K-3647	O-1073	K-5781	O-2116	K-5890	O-2282	
O-460	O-2300	GOKIT41	R-6147	K-1204	G-3006	K-1655	DF-485D	K-1655	K-2762	O-2167	K-3726	G-4284	K-5784	G-4443	K-5891	O-2082	
O-461	O-2054	GOKIT42	R-6148	K-1211	G-3166	K-1656	DF-485E	K-1656	K-2763	E-6503	K-3770	G-3236	K-5785	G-4325	K-5892	O-2002	
O-462	G-5031	GOKIT43	R-6149	K-1216	G-3143	K-1660	RF-481	K-1660	K-2764	O-2228	K-4015	O-2041	K-5786	G-3131	K-5893	O-2100	
O-463	O-2297	GOKIT44	R-6150	K-1217	O-2020	K-1730	O-1039	K-1730	K-2768	G-3220	K-4018	O-2095	K-5788	O-2105	K-5894	O-1062	
O-464	G-5060	GOKIT45	R-6145	K-1226	G-3282	K-1732	O-2106	K-1732	K-2769	O-2032	K-4040	O-2114	K-5789	O-2080	K-5895	O-1056	
O-465	O-2294	GOKIT46	R-6121	K-1227	G-3125	K-1751	O-2133	K-1751	K-2770	K-6008	K-4048	G-4327	K-5790	G-4120	K-5896	G-4324	
O-466	O-1101	GOKIT47	R-6144	K-1232	G-3128	K-1753	G-5104	K-1753	K-2771	K-6009	K-4125	G-3175	K-5791	O-1060	K-5897	G-4296	
O-467	O-2292	GOKIT49	R-6170	K-1233	G-3250	K-1754	G-3239	K-1754	K-2775	O-2262	K-4135	O-1029	K-5792	O-2195	K-5898	O-1071	
O-469	O-2305	GOKIT50	R-6171	K-1234	G-3178	K-1755	G-5146	K-1755	K-2777	O-2172	K-4136	O-1063	K-5793	O-2262	K-5899	O-2189	
O-628	O-2302	GOKIT51	R-6155	K-1239	G-5039	K-1759	HA-460	K-1759	K-2778	O-2028	K-4277	O-2218	K-5794	G-4221	K-5900	O-2059	
SHAFT EXT.		GOKIT52	R-6156	K-1240	G-5003	K-1761	G-3011	K-1761	K-2779	O-2106	K-4465	G-4298	K-5795	O-2129	K-5901	O-2215	
150	E-6502	GOKIT55	R-6158	K-1241	G-4290	K-1762	G-3009	K-1762	K-2780	G-4104	K-4471	O-2402	K-5796	G-4002	K-5904	O-1100	
151	E-6503	GOKIT57	R-6160	K-1242	G-4227	K-1781	G-3170	K-1781	K-2782	O-2041	K-4491	O-2124	K-5797	G-3141	K-5905	O-2024	
154	E-6504	GOKIT58	R-6162	K-1244	G-4124	K-1801	G-4294	K-1801	K-2783	E-6504	K-4494	O-2041	K-5798	G-4290	K-5906	O-2071	
155	E-6505	GOKIT59	R-6166	K-1258	G-3020	K-1802	G-3230	K-1802	K-2792	O-2236	K-4620	O-2111	K-5799	O-2195	K-5907	O-1048	
156	E-6506	GOKIT60	R-6167	K-1260	O-2121	K-1803	G-3225	K-1803	K-2793	G-5046	K-4621	O-1082	K-5800	O-2160	K-5908	O-2256	
WINT. PLUGS		GOKIT61	R-6165	K-1263	G-5053	K-1804	G-3145	K-1804	K-2795	O-2266	K-4625	G-4409	K-5801	O-2053	K-5909	O-2115	
80010	WP-10	GOKIT62	R-6168	K-1264	G-3150	K-1805	G-4309	K-1805	K-2796	O-2139	K-4839	G-4337	K-5802	O-2017	K-5910	O-2040	
80011	WP-11	GOKIT63	R-6164	K-1265	O-2112	K-1965	G-4134	K-1965	K-2797	G-5016	K-4840	G-4008	K-5803	O-2106	K-5911	O-1070	
80012	WP-12	GOKIT64	R-6163	K-1266	G-3259	K-1966	G-3203	K-1966	K-2800	O-2195	K-4939	O-2006	K-5804	O-2208	K-5912	O-2015	
8004	WP-04	GOKIT65	R-6161	K-1267	O-2017	K-2009	O-2002	K-2009	K-2801	O-2124	K-4944	O-2195	K-5805	G-4310	K-5914	O-2226	
8006	WP-06	FILTER KITS		K-1268	O-2134	K-2011	O-2200	K-2011	K-2802	O-2135	K-5030	O-2124	K-5806	G-5024	K-5915	O-2080	
8007	WP-07	ROKIT201	F-8316	K-1269	G-5034	K-2014	O-2104	K-2014	K-2803	O-2133	K-5035	O-2144	K-5807	O-2142	K-5916	O-2409	
8008	WP-08	ROKIT202	F-8317	K-1271	O-2038	K-2016	O-2188	K-2016	K-2804	O-2261	K-5060	O-2024	K-5808	G-4278	K-5917	G-5061	
8009	WP-09	ROKIT211	F-8324	K-1272	O-2135	K-2019	O-2126	K-2019	K-2805	O-2091	K-5063	O-2209	K-5809	G-4237	K-5918	O-2294	
PUMP SEALS		ROKIT220	F-8301	K-1274	O-2209	K-2020	O-2024	K-2020	K-2806	O-1106	K-5098	O-2256	K-5810	O-2175	K-5919	O-2214	
AS-100	MS-100	ROKIT221	F-8302	K-1282	O-2086	K-2021	O-2115	K-2021	K-2807	O-2270	K-5187	RF-455	K-5811	O-2067	K-5920	O-2007	
AS-1000	MS-1000	ROKIT222	F-8303	K-1286C	G-3202	K-2022	O-2068	K-2022	K-2808	O-1044	K-5221	O-2224	K-5813	G-4311	K-5921	O-2195	
AS-101	MS-101	ROKIT223	F-8304	K-1301	G-4186	K-2023	G-4285	K-2023	K-2809	O-2165	K-5225	O-2024	K-5814	O-1042	K-5924	G-3163	
AS-142	MS-142	ROKIT224	F-8305	K-1302	G-3283	K-2024	G-5045	K-2024	K-2810	O-1049	K-5227	G-5031	K-5815	O-2239	K-5927	G-3155	
AS-150	MS-150	ROKIT225	F-8306	K-1303	G-4133	K-2025	O-2054	K-2025	K-2811	O-2116	K-5236	O-2058	K-5816	O-2226	K-5930	G-3271	
AS-162	MS-162	ROKIT226	F-8307	K-1306	G-4132	K-2026	E-6501	K-2026	K-2812	O-1215	K-5243	O-2095	K-5818	O-2224	K-5931	O-2090	
AS-163	MS-163	ROKIT231	F-8315	K-1307	O-2025	K-2027	O-2026	K-2027	K-2813	O-1054	K-5244	O-2181	K-5819	O-2165	K-5932	G-5112	
AS-200	MS-200	ROKIT232	F-8314	K-1308	O-2152	K-2029	O-1059	K-2029	K-2814	O-2095	K-5245	O-1116	K-5820	O-2227	K-5933	G-5114	
AS-201	MS-201	ROKIT233	F-8322	K-1311	O-2226	K-2030	O-2223	K-2030	K-2815	O-2164	K-5246	G-5023	K-5821	O-2256	K-5934	O-2124	
AS-299	MS-299	ROKIT241	F-8307	K-1312	O-2255	K-2031	O-1211	K-2031	K-2816	G-4280	K-5250	G-4223	K-5822	G-5035	K-5936	O-2261	
AS-358	MS-358	ROKIT251	F-8325	K-1313	O-2240	K-2032	O-1212	K-2032	K-2817	O-2067	K-5251	O-2218	K-5823	O-2059	K-5937	O-2253	
AS-359	MS-359	ROKIT261	F-8308	K-1314	G-4131	K-2033	O-2239	K-2033	K-2819	O-2248	K-5254	G-3157	K-5826	O-2153	K-5940	O-2106	
AS-360	MS-360	ROKIT262	F-8309	K-1316	G-4030	K-2035	G-3149	K-2035	K-2820	O-2248	K-5255	G-3158	K-5827	O-2264	K-5942	O-2200	
AS-372	MS-372	ROKIT263	F-8310	K-1317	G-4026	K-2036	G-4440	K-2036	K-2821	O-2256	K-5259	O-2236	K-5828	O-2248	K-5943	O-2209	
AS-381	MS-381	ROKIT264	F-8311	K-1318	G-4114	K-2037	G-3148	K-2037	K-2822	O-2280	K-5263	O-2134	K-5829	G-5026	K-5944	O-2067	
AS-406	MS-406	ROKIT265	F-8312	K-1319	G-4405	K-2038	O-1014	K-2038	K-2823	O-2124	K-5306	O-2214	K-5830	O-1101	K-5945	O-2086	
AS-411	MS-411	ROKIT271	F-8318	K-1322	O-2104	K-2039	O-1060	K-2039	K-2824	O-2155	K-5404	O-2282	K-5831	O-2224	K-5946	O-2249	
AS-416A	MS-416A	ROKIT272	F-8319	K-1336	G-5108	K-2040	O-2040	K-2040	K-2825	O-2117	K-5411	G-4319	K-5832	O-2034	K-5947	G-3247	
AS-4702	MS-2131	ROKIT273	F-8320	K-1367	G-3010	K-2041	O-2114	K-2041	K-2826	G-3002	K-5535	DF-485A	K-5833	O-2220	K-5948	G-4123	
AS-501	MS-501	ROKIT274	F-8321	K-1383	O-2195	K-2042	O-2203	K-2042	K-2827	G-3003	K-5614	G-3012	K-5834	O-2090	K-5949	O-2209	
AS-501	MS-501	ROKIT277	F-8326	K-1384	O-2060	K-2043	G-4309	K-2043	K-2830	O-2095	K-5618	WP-20	K-5836	O-2199	K-5950	O-2189	
AS-501	MS-501	ROKIT279	F-8326	K-1385	O-1082	K-2044	O-2142	K-2044	K-2867	G-3238	K-5685	O-2106	K-5837	O-2049	K-5951	O-2079	
AS-501	MS-501	ROKIT300	F-8107	K-1386	O-1115	K-2045	O-2266	K-2045	K-2868	SF-451	K-5692	O-2175	K-5838	O-2058	K-5952	O-1067	
AS-501	MS-501	ROKIT320	F-8101	K-1387	O-1102	K-2046	G-4295	K-2046	K-2945	G-3006K	K-5693	O-2220	K-5839	O-2278	K-5953	G-3255	
AS-501	MS-501	ROKIT321	F-8102	K-1388	O-1041	K-2048	G-4328	K-2048	K-2954	R-6109	K-5730	O-2090	K-5841	G-3026	K-5954	O-2208	
AS-703	MS-703	ROKIT322	F-8103	K-1389	G-3242	K-2049	G-3273	K-2049	K-2955	R-6110	K-5731	G-5009	K-5842	G-3021	K-5955	O-2144	
AS-800	MS-800	ROKIT323	F-8104	K-1389	G-4290	K-2051	O-2104	K-2051	K-2965	G-4441	K-5732	O-2008	K-5843	O-2165	K-5956	O-2103	
AS-877	MS-877	ROKIT324	F-8105	K-1391	WP-04	K-2052	G-3022	K-2052	K-2966	G-4253	K-5733	O-2150	K-5844	O-2080	K-5957	O-2216	
PUMP KITS		ROKIT325	F-8106	K-1392	WP-06	K-2054	G-4439	K-2054	K-2969	O-2099	K-5734	K-6002	K-5845	O-2247	K-5958	O-2024	
GOKIT01	R-6101	ROKIT330	F-8114	K-1393	WP-07	K-2055	O-1102	K-2055	K-2970	G-3277	K-5738	O-2133	K-5846	O-2054	K-5959	O-2030	
GOKIT02	R-6102	ROKIT361	F-8109	K-1394	WP-08	K-2057	O-1159	K-2057	K-2982	O-1217	K-5739	O-2261	K-5847	O-2205	K-5960	O-2044	
GOKIT03	R-6103	ROKIT362	F-8110	K-1395	WP-09	K-2058	O-1119	K-2058	K-2983	O-2247	K-5740	O-2128	K-5848	O-2131	K-5961		

PRODUCT INDEX

A.O. Smith Type Motor Parts	83-84	Hose Clamps	96	Reverse Cross Ref. (SSC# Order)	36-56
Adhesive-For O-ring Cord	83	Hose Connector	95	ROKIT Type Kits	73-75
Air Bleeder Valves	93	Hose Cuffs	95	Rope Clamps	91
Aladdin Part # Cross Reference	103-104	Hose Parts	100	Rope Eyes	91
Alphabetical Parts Listing	13-35	Hydrovalve Part # Cross Ref.	104	Rough Service Bulbs	89
Aquador Skimmer System	94	Impeller Wedge	86	Rubber Pipe Couplings	95
Armature Holding Tool	86	Impeller Wrenches	86	Saddle Valve	101
Ball Bearings	86	Ladder Foot Bumper and Kit	90	Safety Cover Hardware	91-92
Ball Valves	97-98	Ladder Replacement Parts	90	Screws	93
Bearings	86	Light Wedge	87	Seals	68-69
Boiler Drains	99	Liquid Filled Gauges	78-79	Service Tools	86-87
Brass Ball Valves	98	Lubricants	87-88	Sewage Ejector Check Valve	98
Brass Brush	87	Magnetic Pole Tip	87	Shaft Extensions	83
Bulbs-Rough Service	89	Main Drain Sealing Ring	94	Shaft Puller	86
Capacitors	85	Mfr.'s Part # Cross Reference	13-35	Sheet Metal Screws	93
Century Type Motor Parts	84	Mechanical Packing	101	Silicone Lubricant	88
Check Valves	98	Motor Bearing Puller	86	Sillcock Key	99
Compound Gauges	77	Motor Capacitors	85	Sillcocks	99
Compression Couplings	98	Motor Parts	83-85	Single Union Ball Valves	97
Coverup Basket Cover Tool	87	Motor Thru Bolts	85	Skimmer Cover	94
Cross Reference-Aladdin to SSC	103-104	Needle Valves	79	Skimmer Faceplate Covers	94
Cross Reference-By Equipment	1-12	No-Hub Couplings	96	Skimmer Faceplates	94
Cross Reference-By Mfr.'s #	13-35	OEM Part Number Cross Reference	13-35	Skimmer Screws	93
Cross Reference-By OEM #	13-35	O-ring / Gasket Kits	56	Slick Pick Impeller Cleaner	86
Cross Ref.-By Popular Seals	69	O-ring Cord	82	Slickery Seal Extraction Tool	86
Cross Ref.-Hydrovalve to SSC	104	O-ring Cord Adhesive	83	Slide Flange Hardware	90
Dollar Plugs	97	O-ring List (SSC# Order)	36-48	Socket Gutter Grate	94
Drain Cocks	93	O-ring Puller	87	Stair Screws	93
Duct Tape	88	O-ring Sizing Guide	48, 83	Step Section Gasket	93
Dust Masks	89	Outlet Fittings	95	Sticky Spray	88
Equipment Cross Reference	1-12	Packing	101	Stop and Waste Valves	99
Eye Catcher Tool	86	Picture Guide (Gaskets)	57-67	Teflon Lubricant	87
Faceplates (Skimmer & Return)	94-95	Pipe Couplings	95-96	Teflon Paste	87
Fiberglass Tape Kit	88	Pipe Dope	87	Teflon Tape	87
Filter O-ring / Gasket Kits	73-75	Pipe Flange Bolts and Nuts	102	Tek Screws	93
Frost Free Sillcocks	99	Pipe Flange Gaskets	101-102	Test Caps	96
G.E. Type Motor Parts	84-85	Pipe Repair Clamps	97	Tie Down Straps	89
Gasket Cutting Shears	82, 87	Pipe Repair Tape	88	Tools	86-87
Gasket List (SSC# Order)	49-56	Plastic Case Gauges	77	Torque Wrench	96
Gasket Picture Guide	57-67	Pool Hardware	90-92	Transition Couplings	95
Gasket Removing Solution	88	Pressure Gauges	76-77	Unions	97
Gasket Sheets	80-82	Pump/Motor Shaft Extensions	83	Vacuum Gauges	77
Gauges	76-79	Pump Repair / Service Kits	70-72	Valves-PVC, Brass	97-98
GOKIT Type Kits	70-72	Pump Seals (SSC# Order)	68-69	Vibro-Insulators	89
Grommets	89	PVC Ball Valves	97	Vinyl Gloves	89
Handrail Stabilizing Plugs	90	PVC Fittings	97	Water Test Gauges	79
Hooks	91	PVC Unions	97	Winterizing Plugs	92
Hose Adapter	95	PVC Wire Saw	87	Winterizing Plugs-Plastic	93
Hose Bibbs	99	Return Fitting Faceplate	95	Wire Ties	89
Hose Caps	100	Return Fittings	95	Zoom-Spout Oiler	88

Use the Pool & Spa Industry's Leading Computerized Parts Lookup System to Find Your SSC Replacement Part!

- Flexible, easy-to-use service parts reference and breakdowns
- Point & click exploded parts view
- Thousands of industry manufacturer's parts listed with a cross reference to SSC part numbers.



THE PARTS WIZARD
 by Cardol Data Systems
 1-800-325-4492
<http://www.cardol.com/partswizard>